



catalogo prodotti

products - productos



pitture e vernici - isolamento termico - malte tecniche - pavimenti in resina - sistema tintometrico youcolor
paintes and varnishes - insulated renders - technical mortars - industrial flooring - youcolor tinting system
pinturas y barnices - aislamiento térmico - morteros técnicos - suelo de resina - sistema de tintado youcolor

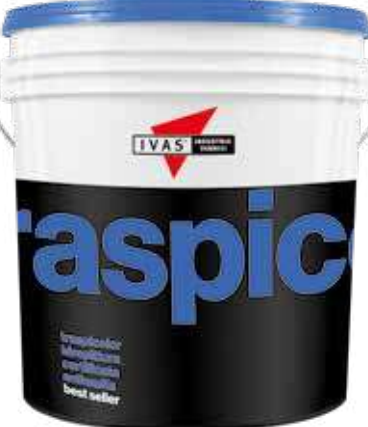

**NUOVO
COLORE
NUOVA
IVAS!**



dal 1953
aggiungiamo valore all'edilizia

seguendo questo principio guida, il Gruppo ha raggiunto una posizione di rilievo nel mercato delle costruzioni.

since 1953
we add value to construction

Following this guiding principle, the Group has reached an important position in the construction market.

desde 1953
agregamos valor a la construcción

Siguiendo este principio el Grupo ha logrado una posición destacada en el mercado de la construcción.





la mission di ivas SpA

**colori e sistemi
per l'edilizia sostenibile**

fin dalla sua fondazione Ivas offre al mercato delle finiture edilizie soluzioni e tecnologie integrate, avendo come punto di riferimento l'alta qualità e il rispetto dell'ambiente.

**colours and systems
for sustainable construction**

Since its foundation, Ivas has been offering integrated solutions and technologies to the market of building finishes, having as its reference point high quality and respect for the environment.

**colores y sistemas
para la construcción sostenible**

desde su fundación, Ivas ha ofrecido soluciones y tecnologías integradas al mercado de acabados de edificación, teniendo como referencia la alta calidad y el respeto al ambiente.

resumen

summary

sommario

| | | |
|---------------------------|--|-----|
| | legenda scheda prodotto | 6 |
| | legenda icone | 8 |
| PITTURE E VERNICI | interno | |
| | best sellers | 14 |
| | idrosmalti | 18 |
| | lavabili | 22 |
| | idropitture | 26 |
| | pitture | 30 |
| | vita sana | 36 |
| | tabella sinottica prodotti da interno | 44 |
| | cicli per interno | 46 |
| | esterno | |
| | paint ht | 50 |
| | exterior ht | 60 |
| | exterior | 66 |
| | tabella sinottica prodotti da esterno | 68 |
| | cicli per esterno | 70 |
| | interno-esterno | |
| | fondi | 74 |
| | fissativi | 78 |
| | stucchi | 82 |
| | coloranti universali | 86 |
| | interno-esterno | |
| | smalti h2O | 88 |
| | smalti | 92 |
| | antiruggini e fondi | 96 |
| | protettivi | 100 |
| | prodotti speciali | 106 |
| | industria | 114 |
| diluenti | 118 | |
| linea piscine | 120 | |
| linea legno | 124 | |
| ISOLAMENTO TERMICO | collanti e rasanti | 132 |
| | collanti e rasanti ht | 136 |
| | collanti e fuganti per modulari | 140 |
| | isolanti | 144 |
| | tasselli ht | 160 |
| | tasselli | 162 |
| | accessori ht | 164 |
| | accessori | 168 |
| | elementi di fissaggio | 176 |
| | davanzali | 182 |
| | reti in fibra di vetro | 184 |
| | finiture | 186 |
| | rivestimenti modulari | 194 |
| | decori e cornici | 196 |
| attrezzature | 198 | |

resumen

summary

sommario

| | | |
|-----------------------|---------------------------|-----|
| MALTE TECNICHE | ripristino cls | 204 |
| | rasanti ht | 210 |
| | rasanti | 216 |
| | calce naturale | 222 |
| | collanti | 228 |
| | sigillanti | 234 |
| | deumidificanti | 238 |
| | massetti | 241 |
| | impermeabilizzanti | 244 |
| | linea casa | 250 |
| | additivi e leganti | 253 |
| | complementi | 255 |

| | | |
|----------------------------|--|-----|
| PAVIMENTI IN RESINA | impregnanti/antipolvere | 260 |
| | promotori d'adesione | 262 |
| | legante per malte spatolate | 264 |
| | rivestimenti a film | 266 |
| | rivestimenti murali | 270 |
| | autolivellanti | 272 |
| | protettivi e impermeabilizzanti | 276 |
| | riempitivi minerali | 278 |
| | poliurea | 280 |
| | accessori | 282 |

| | | |
|------------------|-------------------------------|-----|
| YOU COLOR | macchine tintometriche | 286 |
| | coloranti concentrati | 292 |
| | prodotti a tintometro | 293 |

| | | |
|---|----------------------------|-----|
| [| corner espositivi | 304 |
| | strumenti di vendita | 308 |
| | indice alfabetico prodotti | 310 |

| | | | | | |
|-----|------------------------|-----|---------------------|-----|--------------------------|
| 01. | nome prodotto | 01. | nome product | 01. | nombre del producto |
| 02. | sottotitolo | 02. | subtitle | 02. | subtitular |
| 03. | destinazione d'uso | 03. | intended use | 03. | uso previsto |
| 04. | QR code scheda tecnica | 04. | QR code data sheet | 04. | código QR hoja de datos |
| 05. | immagine confezione | 05. | immagine packaging | 05. | imagen envase |
| 06. | descrizione prodotto | 06. | product description | 06. | descripción del Producto |
| 07. | dati di applicazione | 07. | application data | 07. | datos de la aplicación |
| 08. | icone tecniche | 08. | technical icons | 08. | iconos tecnicos |
| 09. | icone certificazioni | 09. | certifications icon | 09. | iconos certificaciones |
| 10. | icone proprietà | 10. | properties icon | 10. | iconos propiedades |
| 11. | icone tecnologie | 11. | technologies icon | 11. | iconos tecnologías |
| A. | italiano | A. | Italian | A. | italiano |
| B. | inglese | B. | English | B. | inglés |
| C. | spagnolo | C. | Spanish | C. | español |

01.

02.

03.

04.

idromatt



scheda tecnica



data sheet



ficha técnica

05.



06.

07.

| idrosmalto opaco murale | interno esterno | Matt water-based wall enamel | indoor outdoor | Hidroesmalte mate de pared | interior exterior |
|---|-----------------|--|----------------|---|-------------------|
| <p>Idrosmalto opaco murale, dotato di ottima lavabilità e copertura ad alta Resa. A base di resine acriliche all'acqua e cariche pregiate, a viscosità idonea ad evitare colature e schizzi. Particolarmente indicato per ambienti ad uso pubblico. Idoneo per ambienti che devono contenere alimenti, Certificato HACCP. La Classe TVOC A+ lo rende idoneo per ottemperare ai protocolli CAM, Leed e Breeam. Per uso professionale.</p> | | <p>Matt water-based wall enamel with superb washability and high coverage. Based on water-based acrylic resins and high quality fillers, with a viscosity able to prevent dripping and splashing. Particularly suited for use in public places. Suitable for rooms where foodstuffs are stored. HACCP Certified.</p> | | <p>Hidroesmalte mate de pared, dotado de excelente lavabilidad y capacidad cubriente de alto rendimiento. A base de resinas acrílicas al agua y cargas de calidad, con la viscosidad adecuada para evitar goterones y salpicaduras. Particolarmente indicado para espacios públicos. Idóneo para lugares que vayan a contener alimentos, Certificado HACCP. Para uso profesional.</p> | |
| <p>Attrezzatura: pennello, rullo, airless Diluizione: acqua - 5-10% Resa (2 mani): 7-8 m²/l - Per confezione (12 l): 96 m² Colore: bianco e colorato</p> | | <p>Equipment: brush, roller, airless Dilution: water - 5-10% Coverage (2 coats): 7-8 m²/l - Per packaging (12 l): 96 m² Color: white and colored</p> | | <p>Herramientas: brocha, rodillo, pistola pulverizadora Dilución: agua - 5-10% Rendimiento (2 capas): 7-8 m²/l - Por envase (12 l): 96 m² Color: blanco y colorido</p> | |

| tecniche | certificazioni | proprietà | tecnologie |
|---|----------------|---|--------------|
| COLOURABLE WATER BASED BRUSH ROLLER AIRLESS | A+ haccp | S1 WASHABLE V3 BREATHABLE class 2 COVERAGE matt BRILLIANCE | Resistance 5 |

08.

09.

10.

11.

A.

B.

C.

ICONE PROPRIETÀ

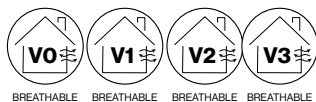

grado di traspirabilità dal più alto al più basso - degree of breathability from the highest to the lowest - grado de transpirabilidad de mayor a menor

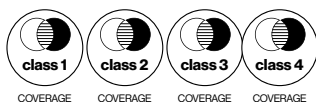

grado di copertura dal più alto al più basso - degree of covering from the highest to the lowest - grado de cobertura de mayor a menor



grado di lavabilità dal più alto al più basso - degree of washability from the highest to the lowest - grado de lavabilidad de mayor a menor



opaco / satinato / lucido
matt / satin / glossy
mate / satinado / brillante



pedonabile - walkable - transitabile



carrabile - carriageable - transitabile



anticondensa - anti condensation -
anticondensación



termico - thermal - térmico



minerale - mineral - mineral



pulibile - cleanable - lavable



tecnologia etica ivas - ivas ethical
technology - ivas tecnologia ética

ICONE TECNOLOGIE



protezione da tutti i ceppi batterici -
protection from all bacterial strains
- protección contra todas las cepas
bacterianas



protezione dall'attacco di alghe,
funghi e muffe - protection against
attack of algae, fungi and moulds -
protección contra el ataque de algas,
hongos y mohos



formulazione idrofobizzante -
hydrophobizzant formulation -
formulación hidrofóbica



nanotecnologia fotocatalitica con
potere autopulente - photocatalytic
nanotechnology with self-cleaning
power - nanotecnología fotocatalítica
con poder autolimpiante



formulazione a pigmenti a basso
assorbimento UV - low UV absorption
pigment formulation - formulación de
pigmento de baja absorción UV



formulazione che minimizza i rischi
di decolorazione nei colori forti -
formulation that minimizes the risk
of discoloration in strong colours -
formulación que minimiza el riesgo de
decoloración en colores fuertes



grado di protezione cls dal più basso
al più alto - degree of protection cls
from lowest to highest - grado de
protección del hormigón de menor
a mayor



percentuale di silossani contenuti
dal più basso al più alto - percentage
of siloxanes contained from lowest to
highest - de menor a mayor



grado di resistenza alla tenuta dal
più basso al più alto - degree of
resistance to leakage from lowest to
highest - grado de resistencia al
estancqueidad de menor a mayor

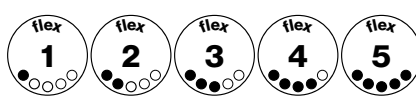

grado di flessibilità dal più basso
al più alto - degree of flexibility
from lowest to highest - grado de
flexibilidad de menor a mayor

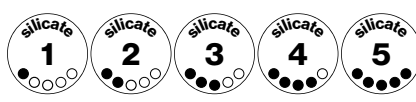

percentuale di silicati contenuti dal
più basso al più alto - percentage
of silicates contained from lowest to
highest - porcentaje de silicatos
contenidos de menor a mayor

ICONE TERMOK8



per bioedilizia - for green building -
para la construcción ecológica



conducibilità termica
thermal conductivity
conductividad térmica
0,023 W/(m·K)



conducibilità termica
thermal conductivity
conductividad térmica
0,040 W/(m·K)



per accedere al bonus
ristrutturazioni 110% - to access
the restructuring bonus 110%
(Italy) - para acceder al bono de
reestructuración del 110% (Italia)



conducibilità termica
thermal conductivity
conductividad térmica
0,025 W/(m·K)



conducibilità termica
thermal conductivity
conductividad térmica
0,045 W/(m·K)



lastre certificate CAM - certified
slabs CAM - placas certificadas
CAM



conducibilità termica
thermal conductivity
conductividad térmica
0,028 W/(m·K)



materiali o sistemi minerali -
mineral materials or systems -
materiales o sistemas minerales



economicità - cost-effectiveness -
rentabilidad



conducibilità termica
thermal conductivity
conductividad térmica
0,029 W/(m·K)



grande resistenza agli urti -
grande resistenza agli urti - gran
resistencia al impacto



elevato isolamento termico - high
thermal insulation - alto aislamiento
térmico



conducibilità termica
thermal conductivity
conductividad térmica
0,030 W/(m·K)



grande resistenza al fuoco - great
resistance to fire - gran resistencia
al fuego



lastre certificate EPD - certified
slabs EPD - placas certificadas
EPD



conducibilità termica
thermal conductivity
conductividad térmica
0,031 W/(m·K)



TermoK8 modular design



facilità di posa - ease of installation -
facilidad de instalación



conducibilità termica
thermal conductivity
conductividad térmica
0,032 W/(m·K)

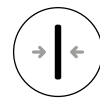

per sistemi con spessori ridotti - for
systems with reduced thickness
- para sistemas con espesores
reducidos



per isolamento termoacustico - for
thermal and acoustic insulation -
para aislamiento térmico y acústico



conducibilità termica
thermal conductivity
conductividad térmica
0,033 W/(m·K)



per superfici difficili - for difficult
surfaces - para superficies difíciles



TermoK8 design



conducibilità termica
thermal conductivity
conductividad térmica
0,034 W/(m·K)



conducibilità termica
thermal conductivity
conductividad térmica
0,020 W/(m·K)



conducibilità termica
thermal conductivity
conductividad térmica
0,035 W/(m·K)



conducibilità termica
thermal conductivity
conductividad térmica
0,021 W/(m·K)



conducibilità termica
thermal conductivity
conductividad térmica
0,036 W/(m·K)



IVAS[®]

**INDUSTRIA
VERNICI**

**DIVISIONE
PITTURE E VERNICI**

**PIT
TURE
E
VER
NICI**



best

prodotti

traspicolor active

enjoy 1 coat



sellere

traspicolar active



scheda
tecnica



data
sheet



ficha
técnica



| idropittura traspirante antimuffa certificata | interno | matt washable water-based paint with masking effect | indoor | pittura al acqua traspirante antimoho certificata | interiores |
|---|---------|--|--------|---|------------|
| <p>Idropittura murale antimuffa altamente traspirante formulata con resine viniliche con elevata copertura e punto di bianco. Questa pittura contiene prodotto biocida con proprietà fungicida e algicida basato sul principio attivo active. Certificato dal Fraunhofer-Institut für Bauphysik di Monaco. La Classe TVOC A+ lo rende idoneo per ottemperare ai protocolli CAM, Leed Breeam. Per uso professionale.</p> <p>Attrezzatura: pennello, rullo, airless Diluizione: acqua - 20-25% Resa (2 mani): 4-5 m²/l - Per confezione (14 l): 70 m² Colore: solo bianco</p> | | <p>Highly breathable water-based paint resistant to mould and mildew formulated with vinyl resins offering high coverage and whiteness. This paint contains a biocidal product with fungicidal and algacidal properties based on the active ingredient. Certified by Fraunhofer-Institut für Bauphysik of Munich. Classified TVOC A+, it complies with Leed Breeam protocols. For professional use.</p> <p>Equipment: brush, roller, airless Dilution: water - 20-25% Coverage (2 coats): 4-5 m²/l - Per packaging (14 l): 70 m² Color: only white</p> | | <p>Pintura al agua de pared altamente traspirante antimoho formulada con resinas vinilicas con gran capacidad cubriente y agradable punto de blanco. Esta pintura contiene un producto biocida con propiedades fungicidas y algucidas basadas en el principio activo active. Certificada por el Fraunhofer-Institut für Bauphysik de Munich. La Clase TVOC A+ la hace idónea para cumplir con los protocolos Leed Breeam. Para uso profesional.</p> <p>Herramientas: brocha, rodillo, pistola pulverizadora Dilución: agua - 20-25% Rendimiento (2 capas): 4-5 m²/l - Por envase (14 l): 70 m² Color: solo blanco</p> | |

| tecniche | certificazioni | proprietà | tecnologie |
|---|---------------------|-----------------------------------|------------|
| WATER BASED BRUSH ROLLER AIRLESS | A+ muffe batteri | V1 BREATHABLE class 2 COVERAGE | active |

enjoy 1 coat



scheda
tecnica



data
sheet



ficha
técnica



| idropittura lavabile a mano unica | interno | Single coat, washable water-based paint | indoor | pittura al agua lavable de una sola mano | interiores |
|---|---------|--|--------|--|------------|
| Idropittura lavabile a mano unica a base di resine acriliche ed extender molto fini che conferiscono un'eccezionale copertura e gradevole punto di bianco. Forma una finitura uniforme applicando un'unica mano. Ideale per cartongesso. La Classe TVOC A+ lo rende idoneo per ottemperare ai protocolli CAM, Leed e Breeam. Per uso professionale. | | Single coat, washable water-based paint with acrylic resins and very fine extenders that ensure exceptional coverage and an attractive degree of whiteness. Forms a uniform topcoat in a single application. Ideal for plasterboard. Classified TVOC A+, it complies with Leed Breeam protocols. For professional use. | | Pintura al agua lavable de una sola mano a base de resinas acrílicas y extender muy finos que proporcionan una excepcional capacidad cubriente y un agradable punto de blanco. Forma un acabado uniforme aplicando una sola mano. Ideal para cartón-yeso. La Clase TVOC A+ la hace idónea para cumplir con los protocolos Leed Breeam. Para uso profesional. | |
| Attrezzatura: pennello, rullo, airless Diluizione: pronto all'uso Resa (1 mano): 5-6 m ² /l - Per confezione (14 l): 70-80 m ² Colore: bianco e colorato | | Equipment: brush, roller, airless Dilution: ready to use Coverage (1 coat): 5-6 m ² /l - Per packaging (14 l): 70-80 m ² Color: white and colored | | Herramientas: brocha, rodillo, pistola pulverizadora Dilución: listo para usar Rendimiento (1 capa): 5-6 m ² /l - Por envase (14 l): 70-80 m ² Color: blanco y colorido | |

| tecniche | | | | | | certificazioni | | proprietà | | | | tecnologie | | | |
|----------|--|--|--|--|--|----------------|--|-----------|--|--|--|------------|--|--|--|
| | | | | | | | | | | | | | | | |



idrosm

idrosmalti murali di alto pregio

prodotti

idromatt

idrosatin

idrogloss



malati

idromatt



scheda
tecnica



data
sheet



ficha
técnica

| idrosmalto opaco murale | interno esterno | matt water-based wall enamel | indoor outdoor | hidroesmalte mate de pared | interior exterior |
|--|-----------------|--|----------------|--|-------------------|
| <p>Idrosmalto opaco murale, dotato di ottima lavabilità e copertura ad alta resa. A base di resine acriliche all'acqua e cariche pregiate, a viscosità idonea ad evitare colature e schizzi. Particolarmente indicato per ambienti ad uso pubblico. Idoneo per ambienti che devono contenere alimenti, Certificato HACCP. La Classe TVOC A+ lo rende idoneo per ottemperare ai protocolli CAM, Leed e Breeam. Per uso professionale.</p> | | <p>Matt water-based wall enamel with superb washability and high coverage. Based on water-based acrylic resins and high quality fillers, with a viscosity able to prevent dripping and splashing. Particularly suited for use in public places. Suitable for rooms where foodstuffs are stored. HACCP Certified. Classified TVOC A+, it complies with Leed Breeam protocols. For professional use.</p> | | <p>Hidroesmalte mate de pared, dotado de excelente lavabilidad y capacidad cubriente de alto rendimiento. A base de resinas acrílicas al agua y cargas de calidad, con la viscosidad adecuada para evitar goterones y salpicaduras. Particolarmente indicado para espacios públicos. Idóneo para lugares que vayan a contener alimentos, Certificado HACCP. La Clase TVOC A+ la hace idónea para cumplir con los protocolos Leed Breeam. Para uso profesional.</p> | |
| <p>Attrezzatura: pennello, rullo, airless Diluizione: acqua - 5-10% Resa (2 mani): 7-8 m²/l - Per confezione (12 l): 96 m² Colore: bianco e colorato</p> | | <p>Equipment: brush, roller, airless Dilution: water - 5-10% Coverage (2 coats): 7-8 m²/l - Per packaging (12 l): 96 m² Color: white and colored</p> | | <p>Herramientas: brocha, rodillo, pistola pulverizadora Dilución: agua - 5-10% Rendimiento (2 capas): 7-8 m²/l - Por envase (12 l): 96 m² Color: blanco y colorido</p> | |

| tecniche | certificazioni | proprietà | tecnologie |
|--|---|--|--|
|  COLOURABLE  WATER BASED  BRUSH  ROLLER  AIRLESS |  A+  haccp |  S1 WASHABLE  V3 BREATHABLE  class 2 COVERAGE  matt BRILLIANCE |  resistance 5 |

idrosatin



scheda
tecnica



data
sheet



ficha
técnica

| idrosmalto satinato murale | interno esterno | satin water-based wall enamel | indoor outdoor | hidroesmalte satinado de pared | interior exterior |
|---|-----------------|---|----------------|--|-------------------|
| <p>Idrosmalto satinato murale, dotato di ottima lavabilità e copertura ad alta resa. A base di resine acriliche all'acqua e cariche pregiate, a viscosità idonea ad evitare colature e schizzi. Particolarmente indicato per ambienti ad uso pubblico. Idoneo per ambienti che devono contenere alimenti, Certificato HACCP. La Classe TVOC A+ lo rende idoneo per ottemperare ai protocolli CAM, Leed e Breeam. Per uso professionale.</p> | | <p>Satin water-based wall enamel with superb washability and high coverage. Based on water-based acrylic resins and high quality fillers, with a viscosity able to prevent dripping and splashing. Particularly suited for use in public places. Suitable for rooms where foodstuffs are stored. HACCP Certified. Classified TVOC A+, it complies with Leed Breeam protocols. For professional use.</p> | | <p>Hidroesmalte satinado de pared, dotado de excelente lavabilidad y capacidad cubriente de alto rendimiento. A base de resinas acrílicas al agua y cargas de calidad, con la viscosidad adecuada para evitar goterones y salpicaduras. Particolarmente indicado para espacios públicos. Idóneo para lugares que vayan a contener alimentos, Certificado HACCP. La Clase TVOC A+ la hace idónea para cumplir con los protocolos Leed Breeam. Para uso profesional.</p> | |
| <p>Attrezzatura: pennello, rullo, airless Diluizione: acqua - 5-10% Resa (2 mani): 7-8 m²/l - Per confezione (12 l): 96 m² Colore: bianco e colorato</p> | | <p>Equipment: brush, roller, airless Dilution: water - 5-10% Coverage (2 coats): 7-8 m²/l - Per packaging (12 l): 96 m² Color: white and colored</p> | | <p>Herramientas: brocha, rodillo, pistola pulverizadora Dilución: agua - 5-10% Rendimiento (2 capas): 7-8 m²/l - Por envase (12 l): 96 m² Color: blanco y colorido</p> | |

| tecniche | certificazioni | proprietà | tecnologie |
|--|---|---|--|
|  COLOURABLE  WATER BASED  BRUSH  ROLLER  AIRLESS |  A+  haccp |  S1 WASHABLE  V3 BREATHABLE  class 2 COVERAGE  satin BRILLIANCE |  resistance 5 |

idrogloss



scheda
tecnica



data
sheet



ficha
técnica



| idrosmalto lucido murale | interno esterno | glossy water-based enamel for walls | indoor outdoor | esmalte al agua brillante para paredes | interior exterior |
|--|-----------------|---|----------------|---|-------------------|
| <p>Idrosmalto lucido murale, dotato di ottima lavabilità e copertura ad alta Resa. A base di resine acriliche all'acqua e cariche pregiate, a viscosità idonea ad evitare colature e schizzi. Particolarmente indicato per ambienti ad uso pubblico. Idoneo per ambienti che devono contenere alimenti, Certificato HACCP. La Classe TVOC A+ lo rende idoneo per ottemperare ai protocolli CAM, Leed e Breeam. Per uso professionale.</p> | | <p>Satin water-based wall enamel with superb washability and high coverage. Based on water-based acrylic resins and high quality fillers, with a viscosity able to prevent dripping and splashing. Particularly suited for use in public places. Suitable for rooms where foodstuffs are stored. HACCP Certified. Classified TVOC A+, it complies with Leed Breeam protocols. For professional use.</p> | | <p>Hidroesmalte brillante de pared, dotado de excelente lavabilidad y capacidad cubriente de alto rendimiento. A base de resinas acrílicas al agua y cargas de calidad, con la viscosidad adecuada para evitar goterones y salpicaduras. Particolarmente indicado para espacios públicos. Idóneo para lugares que vayan a contener alimentos, Certificado HACCP. La Clase TVOC A+ la hace idónea para cumplir con los protocolos Leed Breeam. Para uso profesional.</p> | |
| <p>Attrezzatura: pennello, rullo, airless Diluizione: acqua - 5-10% Resa (2 mani): 7-8 m²/l - Per confezione (12 l): 96 m² Colore: bianco e colorato</p> | | <p>Equipment: brush, roller, airless Dilution: water - 5-10% Coverage (2 coats): 7-8 m²/l - Per packaging (12 l): 96 m² Color: white and colored</p> | | <p>Herramientas: brocha, rodillo, pistola pulverizadora Dilución: agua - 5-10% Rendimiento (2 capas): 7-8 m²/l - Por envase (12 l): 96 m² Color: blanco y colorido</p> | |

| tecniche | certificazioni | proprietà | tecnologie |
|----------|----------------|-----------|------------|
| | | | |

lavabili

lavabili di alto pregio

prodotti

clean matt

luxury

tech active

sol-tex



clean matt



| | | |
|---|---|---|
| <p>idropittura superlavabile smacchiabile agli ioni d'argento</p> <p>interno</p> | <p>highly washable stain-resistant water-based paint with silver ions</p> <p>indoor</p> | <p>pittura al acqua superlavabile, fácil de limpiar, con iones de plata</p> <p>interiores</p> |
| <p>Idropittura superlavabile smacchiabile, contenente ioni d'argento attivi nel contrastare in modo naturale la proliferazione dei microrganismi quali muffe e batteri. La nuova tecnologia Clean conferisce al prodotto elevata resistenza alle macchie e da una estrema facilità di pulizia. Certificato per ambienti che devono contenere alimenti e certificato HACCP. La Classe TVOC A+ lo rende idoneo per ottemperare ai protocolli CAM, Leed Breeam. Per uso professionale.</p> | <p>Highly washable stain-resistant water-based paint with active silver ions that naturally counter the proliferation of microorganisms such as mould, mildew and bacteria. The new Clean technology makes the product highly resistant to stains and easy to clean. Certified for rooms where foodstuffs are stored and HACCP certified. Classified TVOC A+, it complies with Leed Breeam protocols. For professional use.</p> | <p>Pintura al agua superlavable, fácil de limpiar, contiene iones de plata activos que combaten de forma natural la proliferación de los microorganismos como mohos y bacterias. La nueva tecnología Clean proporciona al producto una gran resistencia a las manchas y extrema facilidad de limpieza. Certificada para lugares que vayan a contener alimentos y certificada HACCP. La Clase TVOC A+ la hace idónea para cumplir con los protocolos Leed Breeam. Para interiores. Para uso profesional.</p> |
| <p>Attrezzatura: pennello, rullo, airless Diluizione: pronto all'uso Resa (2 mani): 5-6 m²/l - Per confezione (12 l): 72 m² Colore: bianco e colorato</p> | <p>Equipment: brush, roller, airless Dilution: ready to use Coverage (2 coats): 5-6 m²/l - Per packaging (12 l): 72 m² Color: white and colored</p> | <p>Herramientas: brocha, rodillo, pistola pulverizadora Dilución: listo para usar Rendimiento (2 capas): 5-6 m²/l - Por envase (12 l): 72 m² Color: blanco y colorido</p> |



scheda
tecnica



data
sheet



ficha
técnica

tecniche



COLOURABLE



WATER BASED



BRUSH



ROLLER



AIRLESS



READY TO USE

certificazioni



proprietà



tecnologie

luxury



| | | |
|---|--|--|
| <p>idropittura superlavabile opaca</p> <p>interno esterno</p> | <p>matt highly washable water-based paint</p> <p>indoor outdoor</p> | <p>pittura al acqua superlavabile mate</p> <p>interior exterior</p> |
| <p>Idropittura superlavabile opaca a base di resine acriliche in dispersione acquosa, cariche minerali inerti e pigmenti selezionati solidi alla luce. Ottima copertura e bassa presa: di sporco. Mantiene un aspetto vellutato e uniforme anche su superfici lisce. La Classe TVOC A+ lo rende idoneo per ottemperare ai protocolli CAM, Leed e Breeam. Per uso professionale.</p> | <p>Matt highly washable water-based paint with acrylic resins dispersed in water, inert mineral fillers and selected lightfast pigments. Superb coverage and low dirt retention. Maintains a uniform, velvety appearance, even on smooth surfaces. Classified TVOC A+, it complies with Leed Breeam protocols. For professional use.</p> | <p>Pintura al agua superlavable mate a base de resinas acrílicas en dispersión acuosa, cargadas minerales inertes y pigmentos seleccionados sólidos a la luz. Excelente capacidad cubriente y baja retención de suciedad. Mantiene un aspecto aterciopelado y uniforme también sobre superficies lisas. La Clase TVOC A+ la hace idónea para cumplir con los protocolos Leed Breeam. Para uso profesional.</p> |
| <p>Attrezzatura: pennello, rullo, airless Diluizione: acqua - 10-15% Resa (2 mani): 6-8 m²/l - Per confezione (12 l): 96 m² Colore: bianco e colorato</p> | <p>Equipment: brush, roller, airless Dilution: water - 10-15% Coverage (2 coats): 6-8 m²/l - Per packaging (12 l): 96 m² Color: white and colored</p> | <p>Herramientas: brocha, rodillo, pistola pulverizadora Dilución: agua - 10-15% Rendimiento (2 capas): 6-8 m²/l - Por envase (12 l): 96 m² Color: blanco y colorido</p> |



scheda
tecnica



data
sheet



ficha
técnica

tecniche



COLOURABLE



WATER BASED



BRUSH



ROLLER



AIRLESS

certificazioni



proprietà



tecnologie

tech active



scheda
tecnica



data
sheet



ficha
técnica



| | | |
|---|--|---|
| <p>idropittura lavabile opaca mascherante antimuffa</p> <p>interno</p> | <p>matt washable water-based paint with masking effect</p> <p>indoor</p> | <p>pintura al agua lavable mate con efecto enmascarante</p> <p>interiores</p> |
| <p>Idropittura lavabile opaca mascherante ad elevata copertura e punto di bianco. La sua particolare reologia fornisce ottima distensione e facilità di applicazione. Possiede inoltre caratteristiche antischizzo che facilitano l'applicazione a rullo. Consigliato per cartongesso. La Classe TVOC A+ lo rende idoneo per ottemperare ai protocolli CAM, Leed e Breeam. Questa pittura contiene prodotto biocida con proprietà fungicida e algicida basato sul principio attivo active. Per uso professionale.</p> | <p>Matt washable water-based paint with high coverage and whiteness. Its special rheology ensures excellent spreadability and easy application. It also prevents splashing thus facilitating roller application. Recommended for plasterboard. Classified TVOC A+, it complies with Leed Breeam protocols. This paint contains a biocidal product with fungicidal and algicidal properties based on the active ingredient. For professional use.</p> | <p>Pintura al agua lavable mate con efecto enmascarante de alta capacidad cubriente y punto de blanco. Su particular reologia proporciona una excelente distensión y facilidad de aplicación. Posee además características antisalpicadura que facilita la aplicación con rodillo. Aconsejada para cartón-yeso. La Clase TVOC A+ la hace idónea para cumplir con los protocolos Leed Breeam. Esta pintura contiene un producto biocida con propiedades fungicidas y algucidas basadas en el principio activo active. Para interiores. Para uso profesional.</p> |
| <p>Attrezzatura: pennello, rullo, airless Diluizione: acqua - 10-15% Resa (2 mani): 6-7 m²/l - Per confezione (14 l): 98 m² Colore: bianco e colorato</p> | <p>Equipment: brush, roller, airless Dilution: water - 10-15% Coverage (2 coats): 6-7 m²/l - Per packaging (14 l): 98 m² Color: white and colored</p> | <p>Herramientas: brocha, rodillo, pistola pulverizadora Dilución: agua - 10-15% Rendimiento (2 capas): 6-7 m²/l - Por envase (14 l): 98 m² Color: blanco y colorido</p> |

| | | | |
|---|------------------------------|---|--|
| <p>tecniche</p> <p>COLOURABLE WATER BASED BRUSH ROLLER AIRLESS</p> | <p>certificazioni</p> | <p>proprietà</p> <p>class 2 COVERAGE S2 WASHABLE matt BRILLIANCE</p> | <p>tecnologie</p> <p>active</p> |
|---|------------------------------|---|--|

sol-tex



scheda
tecnica



data
sheet



ficha
técnica



| | | |
|--|---|---|
| <p>idropittura lavabile riempitiva</p> <p>interno</p> | <p>Washable water-based paint with filling power</p> <p>indoor</p> | <p>pintura al agua lavable para relleno</p> <p>interiores</p> |
| <p>Idropittura lavabile ad alto riempimento formulata a base di resine acriliche in dispersione acquosa, cariche minerali inerti e pigmenti selezionati solidi alla luce. La Classe TVOC A+ lo rende idoneo per ottemperare ai protocolli CAM, Leed e Breeam. Per uso professionale.</p> | <p>Washable water-based paint with high filling power, based on acrylic resins dispersed in water, inert mineral fillers and selected lightfast pigments. Classified TVOC A+, it complies with Leed Breeam protocols. For professional use.</p> | <p>Pintura al agua lavable con alta capacidad de relleno formulada a base de resinas acrílicas en dispersión acuosa, cargas minerales inertes y pigmentos seleccionados sólidos a la luz. La Clase TVOC A+ la hace idónea para cumplir con los protocolos Leed y Breeam. Para interiores. Para uso profesional.</p> |
| <p>Attrezzatura: pennello, rullo, airless Diluizione: acqua - 20-25% Resa (2 mani): 6-7 m²/l - Per confezione (14 l): 98 m² Colore: bianco e colorato</p> | <p>Equipment: brush, roller, airless Dilution: water - 20-25% Coverage (2 coats): 6-7 m²/l - Per packaging (14 l): 98 m² Color: white and colored</p> | <p>Herramientas: brocha, rodillo, pistola pulverizadora Dilución: agua - 20-25% Rendimiento (2 capas): 6-7 m²/l - Por envase (14 l): 98 m² Color: blanco y colorido</p> |

| | | | |
|---|------------------------------|---|--------------------------|
| <p>tecniche</p> <p>COLOURABLE WATER BASED BRUSH ROLLER AIRLESS</p> | <p>certificazioni</p> | <p>proprietà</p> <p>V2 BREATHABLE class 2 COVERAGE S3 WASHABLE matt BRILLIANCE</p> | <p>tecnologie</p> |
|---|------------------------------|---|--------------------------|



idropitt

idropitture murali

prodotti

silan tech

traspinterno

bianco cream

mural verde

ture

silan tech



scheda
tecnica



data
sheet



ficha
técnica



| | | | | | |
|--|----------------|---|---------------|---|-------------------|
| idropittura traspirante acrisilossanica antimuffa | interno | breathable water-based acrylic-siloxane paint resistant to mould and mildew | indoor | pittura al acqua traspirante acrisilossanica antimoho | interiores |
| Idropittura a base di resine acrisilossaniche e cariche minerali che la rendono altamente traspirante ed idrorepellente. Questa pittura contiene prodotto biocida con proprietà fungicida e algicida basato sul principio attivo active. Particolarmente indicata su cicli deumidificanti e minerali. Per uso professionale. | | Water-based paint with acrylic-siloxane resins and mineral fillers that make it highly breathable and water-repellent. This paint contains a biocidal product with fungicidal and algicidal properties based on the active ingredient. Particularly suitable for dehumidifying and mineral processes. For professional use. | | Pintura al agua a base de resinas acrisilossanicas y cargas minerales que la hacen muy traspirante e hidro-repelente. Esta pintura contiene un producto biocida con propiedades fungicidas y algucidas basadas en el principio activo active. Particularmente indicada para ciclos deshumidificantes y minerales. Para uso profesional. | |
| Attrezzatura: pennello, rullo, airless Diluizione: acqua - 15-20% Resa (2 mani): 4-5 m ² /l - Per confezione (14 l): 70 m ² Colore: bianco e colorato | | Equipment: brush, roller, airless Dilution: water - 15-20% Coverage (2 coats): 4-5 m ² /l - Per packaging (14 l): 70 m ² Color: white and colored | | Herramientas: brocha, rodillo, pistola pulverizadora Dilución: agua - 15-20% Rendimiento (2 capas): 4-5 m ² /l - Por envase (14 l): 70 m ² Color: blanco y colorido | |

| tecniche | certificazioni | proprietà | tecnologie |
|----------|----------------|-----------|------------|
| | | | |

traspinterno



scheda
tecnica



data
sheet



ficha
técnica



| | | | | | |
|---|----------------|--|---------------|---|-------------------|
| idropittura traspirante universale | interno | universal breathable water-based paint for indoor use | indoor | pittura al acqua traspirante universale para interiores | interiores |
| Idropittura murale traspirante formulata con resine viniliche, cariche ed inerti, bilanciati in modo da ottenere una finitura alcaliresistente e con un punto di bianco caldo. Facile applicazione. Possibilità di realizzare colori chiari e tinte tenui. Per uso professionale. | | Breathable, water-based wall paint formulated with vinyl resins, fillers and inert material, balanced to produce an alkali-resistant topcoat with warm whiteness. Easy to apply. Light and pastel colours can be produced. For professional use. | | Pintura al agua de pared, traspirante, formulada con resinas vinilicas, cargas y áridos, equilibrados de modo que se pueda obtener un acabado resistente a los álcalis y con un punto de blanco cálido. Fácil aplicación. Posibilidad de realizar colores claros y tintes tenuis. Para uso profesional. | |
| Attrezzatura: pennello, rullo, airless Diluizione: acqua - 20-25% Resa (2 mani): 3,5-4,5 m ² /l - Per confezione (14 l): 63 m ² Colore: bianco e colorato | | Equipment: brush, roller, airless Dilution: water - 20-25% Coverage (2 coats): 3,5-4,5 m ² /l - Per packaging (14 l): 63 m ² Color: white and colored | | Herramientas: brocha, rodillo, pistola pulverizadora Dilución: agua - 20-25% Rendimiento (2 capas): 3,5-4,5 m ² /l - Por envase (14 l): 63 m ² Color: blanco y colorido | |

| tecniche | certificazioni | proprietà | tecnologie |
|----------|----------------|-----------|------------|
| | | | |

white cream



scheda
tecnica



data
sheet



ficha
técnica



| | | | | | |
|---|----------------|--|---------------|---|-------------------|
| idropittura traspirante effetto vellutato | interno | breathable water-based paint with a velvety effect | indoor | pintura al agua transpirante de efecto aterciopelado | interiores |
| Idropittura con elevata copertura, alto riempimento e Resa . Risulta di facile applicazione grazie all'ottima dilatazione e all'alto riempimento. Formulato a base di resine vinilversatiche in dispersione, pigmenti, cariche inerti e idrorepellenti, dotata di alcaliresistenza e traspirabilità. La Classe TVOC A+ lo rende idoneo per ottemperare ai protocolli CAM, Leed Bream. Per uso professionale. | | Water-based paint with high coverage, high filling and coverage. It is easy to apply thanks to its excellent expansion and high filling properties. Formulated with vinyl-versatic resins in dispersion, pigments, inert, water repellent mineral fillers. Provides good alkali resistance and breathability. Classified TVOC A+, it complies with Leed Bream protocols. For professional use. | | Pintura al agua con alta capacidad cubriente, de relleno y con gran rendimiento. Resulta fácil de aplicar gracias a la excelente dilatación y gran capacidad de relleno. Formulada a base de resinas vinilversáticas en dispersión, pigmentos, cargas inertes e hidro-repelentes, dotada de resistencia a los álcalis y transpirabilidad. La Clase TVOC A+ la hace idónea para cumplir con los protocolos Leed Bream. Para uso profesional. | |
| Attrezzatura: pennello, rullo, airless Diluizione: acqua - 30% Resa (2 mani): 4-5 m ² /l - Per confezione (14 l): 70 m ² Colore: solo bianco | | Equipment: brush, roller, airless Dilution: water - 30% Coverage (2 coats): 4-5 m ² /l - Per packaging (14 l): 70 m ² Color: only white | | Herramientas: brocha, rodillo, pistola pulverizadora Dilución: agua - 30% Rendimiento (2 capas): 4-5 m ² /l - Por envase (14 l): 70 m ² Color: solo blanco | |

| tecniche | certificazioni | proprietà | tecnologie |
|---|----------------|-------------------------------|------------|
| WATER BASED BRUSH ROLLER AIRLESS | | BREATHABLE class 1 matt | |

mural verde



scheda
tecnica



data
sheet



ficha
técnica



| | | | | | |
|--|----------------|--|---------------|---|-------------------|
| idropittura murale traspirante opaca | interno | matt breathable water-based wall paint | indoor | pintura al agua de pared transpirante mate | interiores |
| Idropittura murale traspirante opaca a base di resine sintetiche vinilacriliche in dispersione acquosa, pigmenti selezionati, cariche minerali che gli conferiscono un alto grado di pienezza. Ideale come base per realizzare tinte chiare e pastello. Per uso professionale. | | Matt breathable water-based wall paint based on synthetic vinyl-acrylic resins dispersed in water, selected pigments and mineral fillers that impart a high degree of fullness. Ideal as base with which to create light, pastel shades. For professional use. | | Pintura al agua de pared transpirante mate a base de resinas sintéticas vinilacrilicas en dispersión acuosa, pigmentos seleccionados, cargas minerales que les proporcionan un gran cuerpo. Ideal como base para realizar tintes claros y pastel. Para uso profesional. | |
| Attrezzatura: pennello, rullo, airless Diluizione: acqua - 25-30% Resa (2 mani): 3,5-4,5 m ² /l - Per confezione (14 l): 63 m ² Colore: bianco e colorato | | Equipment: brush, roller, airless Dilution: water - 25-30% Coverage (2 coats): 3,5-4,5 m ² /l - Per packaging (14 l): 63 m ² Color: white and colored | | Herramientas: brocha, rodillo, pistola pulverizadora Dilución: agua - 25-30% Rendimiento (2 capas): 3,5-4,5 m ² /l - Por envase (14 l): 63 m ² Color: blanco y colorido | |

| tecniche | certificazioni | proprietà | tecnologie |
|---|----------------|-------------------------------|------------|
| YOU COLOR COLOURABLE WATER BASED BRUSH ROLLER AIRLESS | | BREATHABLE class 2 matt | |



pitture

pitture per interno

prodotti

mural blu

pittura per interni extra

biancocalce

bianco interno

idroflex matt

idroflex gloss

idrofumo



mural blu

scheda
tecnicadata
sheetficha
técnica

| | | | | | |
|--|----------------|---|---------------|---|-------------------|
| idropittura murale traspirante coprente | interno | opaque breathable water-based wall paint | indoor | pittura al acqua de pared traspirante cubriente | interiores |
| Idropittura murale traspirante coprente a base di resine viniliche dotata di ottima copertura e buon punto di bianco. Monocomponente ad essiccamento fisico ideale per rinnovare ed uniformare pareti bianche con un buon risultato estetico. Per uso professionale. | | Opaque breathable water-based paint containing vinyl resins for superb coverage and good whiteness. One-pack, physical drying product ideal for renovations and attractively smoothing out white walls. For professional use. | | Pintura al agua de pared traspirante cubriente a base de resinas vinilicas dotada de excelente capacidad cubriente y buen punto de blanco. Monocomponente de secado fisico ideal para renovar y uniformar paredes blancas con un buen resultado estetico. Para uso profesional. | |
| Attrezzatura: pennello, rullo, airless Diluizione: acqua - 30% Resa (2 mani): 3-4 m ² /l - Per confezione (14 l): 56 m ² Colore: solo bianco | | Equipment: brush, roller, airless Dilution: water - 30% Coverage (2 coats): 3-4 m ² /l - Per packaging (14 l): 56 m ² Color: only white | | Herramientas: brocha, rodillo, pistola pulverizadora Dilución: agua - 30% Rendimiento (2 capas): 3-4 m ² /l - Por envase (14 l): 56 m ² Color: solo blanco | |

| tecniche | | | | certificazioni | | | | proprietà | | | | tecnologie | | | |
|-------------|-------|--------|---------|----------------|--|--|--|-----------|------------|------------|--|------------|--|--|--|
| | | | | | | | | | | | | | | | |
| WATER BASED | BRUSH | ROLLER | AIRLESS | | | | | COVERAGE | BREATHABLE | BRILLIANCE | | | | | |

pittura per interni extra

scheda
tecnicadata
sheetficha
técnica

| | | | | | |
|---|----------------|---|---------------|---|-------------------|
| idropittura murale traspirante tinte tenui | interno | breathable water- based wall paint in soft colours | indoor | pittura al acqua de pared traspirante tintes tenues | interiores |
| Idropittura a base di resine vinilversatiche in dispersione acquosa appositamente studiata per ottimizzare l'applicazione a pennello e rullo e massima traspirabilità. Possibilità di realizzare colori tenui. Per uso professionale. | | Water-based paint containing vinyl-versatic resins dispersed in water, specially designed to optimize application with brush and roller and achieve utmost breathability. Pastel colours can be produced. For professional use. | | Pintura al agua a base de resinas vinilversáticas en dispersión acuosa expresamente estudiada para optimizar la aplicación con brocha y rodillo; máxima transpirabilidad. Posibilidad de realizar colores tenues. Para uso profesional. | |
| Attrezzatura: pennello, rullo, airless Diluizione: acqua - 15-20% Resa (2 mani): 3-4 m ² /l - Per confezione (14 l): 56 m ² Colore: bianco e colorato | | Equipment: brush, roller, airless Dilution: water - 15-20% Coverage (2 coats): 3-4 m ² /l - Per packaging (14 l): 56 m ² Color: white and colored | | Herramientas: brocha, rodillo, pistola pulverizadora Dilución: agua - 15-20% Rendimiento (2 capas): 3-4 m ² /l - Por envase (14 l): 56 m ² Color: blanco y colorido | |

| tecniche | | | | certificazioni | | | | proprietà | | | | tecnologie | | | |
|-------------|-------|--------|---------|----------------|--|--|--|-----------|------------|------------|--|------------|--|--|--|
| | | | | | | | | | | | | | | | |
| WATER BASED | BRUSH | ROLLER | AIRLESS | | | | | COVERAGE | BREATHABLE | BRILLIANCE | | | | | |

biancocalce



scheda
tecnica



data
sheet



ficha
técnica



| | | | | | |
|---|----------------|--|---------------|---|-------------------|
| pittura a base di grassello di calce | interno | lime putty -based paint | indoor | pittura a base de masilla de cal | interiores |
| Pittura minerale formulata con grassello di calce e carbonati micronizzati. La pittura risulta particolarmente idonea per tinteggiare ambienti interni di carattere storico monumentale e per tutte le murature minerali di nuova costruzione. Per uso professionale. | | Mineral-based paint containing lime putty and micronised carbonates. The paint is ideal for interior walls in historic buildings-monuments and for all newly-built mineral walls. For professional use. | | Pintura mineral formulada con masilla de cal y carbonatos micronizados. La pintura resulta particularmente idónea para dar tinte a espacios internos de carácter histórico monumental y para todas las paredes minerales de nueva construcción. Para uso profesional. | |
| Attrezzatura: pennello, rullo, airless Diluizione: acqua - pennello, rullo: 20-30% - airless: 30-35% Resa (2 mani): 3-3,5 m ² /l - Per confezione (14 l): 49 m ² Colore: solo bianco | | Equipment: brush, roller, airless Dilution: water - brush, roller: 20-30% - airless: 30-35% Coverage (2 coats): 3-3,5 m ² /l - Per packaging (14 l): 49 m ² Color: only white | | Herramientas: brocha, rodillo, pistola pulverizadora Dilución: agua - brocha, rodillo: 20-30% - pistola pulverizadora: 30-35% Rendimiento (2 capas): 3-3,5 m ² /l - Por envase (14 l): 49 m ² Color: solo blanco | |

| | | | |
|---|-----------------------|---|-------------------|
| tecniche | certificazioni | proprietà | tecnologie |
| WATER BASED BRUSH ROLLER AIRLESS | | class 4 COVERAGE V1 BREATHABLE matt BRILLIANCE | |

bianco interno



scheda
tecnica



data
sheet



ficha
técnica



| | | | | | |
|--|----------------|--|---------------|--|-------------------|
| idropittura murale coprente opaca | interno | opaque water-based wall paint | indoor | pittura al acqua de pared cubriente mate | interiores |
| Idropittura murale coprente opaca a base di resine vinilversatiche, in dispersione acquosa, cariche inerti; unisce una buona resa a un'ottima facilità di applicazione. Particolarmente adatto alla pitturazione di grandi metrature e cantieristica. Per uso professionale. | | Opaque water-based wall paint with vinyl-versatic resins dispersed in water and inert fillers; combines good coverage with easy application. Particularly suitable for painting large areas and use in construction sites. For professional use. | | Pintura al agua de pared cubriente mate a base de resinas vinilversáticas, en dispersión acuosa, cargas inertes; une un buen rendimiento a una excelente facilidad de aplicación. Particularmente idónea para pintar grandes superficies y en obras. Para uso profesional. | |
| Attrezzatura: pennello, rullo, airless Diluizione: acqua - 40% Resa (2 mani): 3-4 m ² /l - Per confezione (14 l): 56 m ² Colore: solo bianco | | Equipment: brush, roller, airless Dilution: water - 40% Coverage (2 coats): 3-4 m ² /l - Per packaging (14 l): 56 m ² Color: only white | | Herramientas: brocha, rodillo, pistola pulverizadora Dilución: agua - 40% Rendimiento (2 capas): 3-4 m ² /l - Por envase (14 l): 56 m ² Color: solo blanco | |

| | | | |
|---|-----------------------|---|-------------------|
| tecniche | certificazioni | proprietà | tecnologie |
| WATER BASED BRUSH ROLLER AIRLESS | | class 4 COVERAGE V1 BREATHABLE matt BRILLIANCE | |

idrofless matt

scheda
tecnicadata
sheetficha
técnica

| | | | | | |
|--|----------------|---|---------------|---|-------------------|
| Idropittura a spessore plastico bucciato | interno | thick plastic water- based paint with orange-peel finish | indoor | pittura al agua de espesor plástico moteado | interiores |
| Idro Idropittura a spessore plastico bucciato a base di resine copolimeriche in dispersione acquosa, cariche specifiche selezionate di granulometria grossolana. Permette di ottenere il tradizionale effetto bucciato. Per uso professionale. | | Thick plastic water-based paint with orange-peel finish containing copolymer resins dispersed in water and specific coarse-grained fillers. Makes it possible to obtain the traditional orange-peel effect. For professional use. | | Pintura al agua de espesor plástico moteado a base de resinas copoliméricas en dispersión acuosa, cargas específicas seleccionadas de granulometría gruesa. Permite obtener el tradicional efecto moteado. Para uso profesional. | |
| Attrezzatura: pennello, rullo a nido d'ape, rullo di spugna Diluizione: pronto all'uso Resa (2 mani): 2 m ² /l - Per confezione (14 l): 28 m ² Colore: bianco e colorato | | Equipment: brush, honeycomb roller, sponge roller Dilution: ready to use Coverage (2 coats): 2 m ² /l - Per packaging (14 l): 28 m ² Color: white and colored | | Herramientas: brocha, rodillo de alveolos, rodillo de esponja Dilución: listo para usar Rendimiento (2 capas): 2 m ² /l - Por envase (14 l): 28 m ² Color: blanco y colorido | |

| tecniche | certificazioni | proprietà | tecnologie |
|---|----------------|--|--|
|  WATER BASED  BRUSH  ROLLER  READY TO USE | |  satin BRILLIANCE  S3 WASHABLE  matt BRILLIANCE |  resistance 4 |

idrofless gloss

scheda
tecnicadata
sheetficha
técnica

| | | | | | |
|---|----------------|--|---------------|---|-------------------|
| idropittura a spessore plastico lavabile | interno | thick plastic washable water-based paint | indoor | pittura al agua de espesor plástico lavabile | interiores |
| Idropittura a spessore plastico lavabile a base di resine vinilversatiche in dispersione acquosa e cariche minerali, riempitivi selezionati. Idoneo per ottenere film a spessore in mano unica con effetto lucido. Per uso professionale. | | Thick plastic washable water-based paint with vinyl-versatic resins and mineral fillers dispersed in water, selected fillers. Suitable for obtaining thick, glossy films in a single coat. For professional use. | | Pintura al agua de espesor plástico lavable a base de resinas vinilversáticas en dispersión acuosa, cargas minerales y rellenos seleccionados. Idóneo para obtener una película de espesor en una sola mano con efecto brillante. Para uso profesional. | |
| Attrezzatura: pennello, rullo di gomma Diluizione: pronto all'uso Resa (2 mani): 2 m ² /l - Per confezione (14 l): 28 m ² Colore: bianco e colorato | | Equipment: brush, rubber roller Dilution: ready to use Coverage (2 coats): 2 m ² /l - Per packaging (14 l): 28 m ² Color: white and colored | | Herramientas: brocha, rodillo de goma Dilución: listo para usar Rendimiento (2 capas): 2 m ² /l - Por envase (14 l): 28 m ² Color: blanco y colorido | |

| tecniche | certificazioni | proprietà | tecnologie |
|---|----------------|---|--|
|  WATER BASED  BRUSH  ROLLER  READY TO USE | |  S3 WASHABLE  gloss BRILLIANCE |  resistance 4 |

idrofumo



scheda
tecnica



data
sheet



ficha
técnica



| pittura opaca antifumo | interno | matt smoke suppressant paint | indoor | pintura mate antihumo | interiores |
|---|---------|---|--------|--|------------|
| <p>Pittura lavabile opaca antifumo con un elevato grado di copertura. Formulata a base di resine acriliche in dispersione acquosa e cariche minerali speciali che la rendono idonea a trattare ambienti con ingiallimenti dovuti a fumo e fuliggine. La sua formulazione garantisce la non ricomparsa di macchie di nicotina, nerofumo, fuliggine. Inodore. Per uso professionale</p> <p>Attrezzatura: pennello per le impregnazioni, rullo o airless se utilizzato come finitura Diluizione: acqua - 20% Resa (2 mani): 5 m²/l - Per confezione (14 l): 70 m² Colore: solo bianco</p> | | <p>Matt, washable smoke suppressant paint with high coverage. Formulated with acrylic resins dispersed in water and special mineral fillers that make it suitable for treating environments subject to yellowing due to smoke and soot. Its formulation ensures that the stains of nicotine, carbon black and soot will not reappear. Odourless. For professional use.</p> <p>Equipment: brush for impregnation, roller or airless if used as a finishing Dilution: water - 20% Coverage (2 coats): 5 m²/l - Per packaging (14 l): 70 m² Color: only white</p> | | <p>Pintura lavable mate antihumo de alta capacidad cubriente. Formulada a base de resinas acrílicas en dispersión acuosa y cargas minerales especiales que la hacen idónea para tratar espacios con amarilleo debido al humo y el hollín. Su formulación garantiza que no vuelvan a aparecer las manchas de nicotina, el negro de humo, el hollín. Inodoro. Para uso profesional.</p> <p>Herramientas: brocha, rodillo o pistola pulverizadora Dilución: agua - 20% Rendimiento (2 capas): 5 m²/l - Por envase (14 l): 70 m² Color: solo blanco</p> | |

| tecniche | | | | certificazioni | | | | proprietà | | | tecnologie | | | |
|--|---|---|---|----------------|--|--|--|---|---|--|------------|--|--|--|
|  |  |  |  | | | | |  |  |  | | | | |
| WATER BASED | BRUSH | ROLLER | AIRLESS | | | | | WASHABLE | COVERAGE | BRILLIANCE | | | | |

Vita San



vita sa

prodotti

vita bianca
 vita wash
 vita therm
 primer therm
 sana rasotherm
 sana finish
 sana bianca
 sanasil-bio
 sana solux
 sana solux spray
 espositore prodotti
 totem promozionale
 sana salute gel
 sana salute spray
 sana salute pro indoor
 sana salute pro outdoor
 sana salute oxy
 sana salute sprayer pump
 colonna porta gel

a

Pitture Ecologiche

Ipoallergeniche Anti-condensa
 Anti-formaldeide
 Dermatologicamente Testate

Soluzioni Sanitizzanti

Termiche Igienizzanti
 Anti-muffa per il Benessere
 e il Comfort Abitativo

Igienizzanti Virus-stop

per la sanificazione di mani
 utensili ponteggi
 superfici interne ed esterne

na

vita bianca

scheda
tecnicadata
sheetficha
técnica

| idroittura traspirante ipoallergenica | interno | hypoallergenic, breathable water-based paint | indoor | pittura al acqua traspirante hipoalergénica | interiores |
|---|---------|--|--------|--|------------|
| <p>Idroittura traspirante ipoallergenica super copertura con elevato punto di bianco. Formulata con materie non pericolose ed adatta ad ambienti frequentati da soggetti sensibili ad allergie come certificato rapporto di Prova N°263/14/04 (ISPE). L'azione disgregante di aldeidi è certificato dall'Istit. Giordano N°326956. La Classe TVOC A+ lo rende idoneo per ottemperare ai protocolli CAM, Leed Breeam. Per uso professionale.</p> | | <p>Hypoallergenic, breathable water-based paint offering superb coverage and high whiteness. Formulated with materials that are harmless to humans, suitable for rooms accommodating allergy sufferers, as certified by Test Report No. 263/14/04 (ISPE). The disruptive action of aldehydes is certified by Istituto Giordano certificate No. 326956. Classified TVOC A+, it complies with Leed Breeam protocols. For professional use.</p> | | <p>Pittura al acqua traspirante hipoalergénica con supercapacità cubriente y elevado punto de blanco. Formulada con materias no peligrosas e idónea para espacios frecuentados por sujetos sensibles a las alergias como se certifica en el informe de Prueba n.º 263/14/04 (ISPE). La acción disgregante de los aldehidos está certificada por el Instituto Giordano N.º 326956. La Clase TVOC A+ la hace idónea para cumplir con los protocolos Leed Breeam. Para uso profesional.</p> | |
| <p>Attrezzatura: pennello, rullo, airless Diluizione: acqua - 40-50% Resa (2 mani): 4-5 m²/l - Per confezione (12 l): 60 m² Colore: solo bianco</p> | | <p>Equipment: brush, roller, airless Dilution: water - 40-50% Coverage (2 coats): 4-5 m²/l - Per packaging (12 l): 60 m² Color: only white</p> | | <p>Herramientas: brocha, rodillo, pistola pulverizadora Dilución: agua - 40-50% Rendimiento (2 capas): 4-5 m²/l - Por envase (12 l): 60 m² Color: solo blanco</p> | |

| tecniche | certificazioni | proprietà | tecnologie |
|---|--------------------------------------|-------------------------------------|------------|
| WATER BASED BRUSH ROLLER AIRLESS | A+ anallergico abbatte aldeidi | class 1 BREATHABLE BRILLIANCE | |

vita wash

scheda
tecnicadata
sheetficha
técnica

| idroittura lavabile ipoallergenica | interno | hypoallergenic, washable water-based paint | indoor | pittura al acqua lavabile hipoalergénica | interiores |
|---|---------|--|--------|---|------------|
| <p>Idroittura lavabile ipoallergenica dermatologicamente testata con rapporto di prova N°263/14/04 (ISPE) che ne attesta la non pericolosità sull'uomo pertanto l'idoneità ad ambienti frequentati da soggetti sensibili ad allergie. L'azione disgregante di aldeidi è certificato dall'Istit. Giordano N°326956. La Classe TVOC A+ lo rende idoneo per ottemperare ai protocolli CAM, Leed Breeam. Per uso professionale.</p> | | <p>Hypoallergenic, washable water-based paint dermatologically tested with test report No. 263/14/04 (ISPE) certifying that it is harmless to humans and thus suitable for rooms accommodating allergy sufferers. The disruptive action of aldehydes is certified by Istituto Giordano certificate No. 326956. Classified TVOC A+, it complies with Leed Breeam protocols. For professional use.</p> | | <p>Pittura al acqua lavabile hipoalergénica dermatologicamente testada con informe de prueba N.º 263/14/04 (ISPE) que certifica la no peligrosidad para el hombre, y por tanto la idoneidad para espacios frecuentados por sujetos sensibles a las alergias. La acción disgregante de los aldehidos está certificada por el Instituto Giordano N.º 326956. La Clase TVOC A+ la hace idónea para cumplir con los protocolos Leed Breeam. Para uso profesional.</p> | |
| <p>Attrezzatura: pennello, rullo, airless Diluizione: acqua - 15-20% Resa (2 mani): 4-5 m²/l - Per confezione (12 l): 60 m² Colore: bianco e colorato</p> | | <p>Equipment: brush, roller, airless Dilution: water - 15-20% Coverage (2 coats): 4-5 m²/l - Per packaging (12 l): 60 m² Color: white and colored</p> | | <p>Herramientas: brocha, rodillo, pistola pulverizadora Dilución: agua - 15-20% Rendimiento (2 capas): 4-5 m²/l - Por envase (12 l): 60 m² Color: blanco y colorido</p> | |

| tecniche | certificazioni | proprietà | tecnologie |
|--|--------------------------------------|-----------------------------------|------------|
| YOU COLOR WATER BASED BRUSH ROLLER AIRLESS | A+ anallergico abbatte aldeidi | class 2 S3 V2 BRILLIANCE | |

vita therm



scheda
tecnica



data
sheet



ficha
técnica

| | | | | | |
|---|----------------|--|---------------|--|-------------------|
| idropittura traspirante anticondensa | interno | breathable water-based anti-condensation paint | indoor | pintura al agua transpirante anticondensación | interiores |
| <p>Idropittura traspirante anticondensa ipoalergénica dermatologicamente testata con rapporto di prova N°263/14/04 (ISPE) che ne attesta la non pericolosità sull'uomo pertanto l'idoneità ad ambienti frequentati da soggetti sensibili ad allergie. L'azione disgregante di aldeidi è certificato dall'Istit. Giordano N°326956. La Classe TVOC A+ lo rende idoneo per ottemperare ai protocolli CAM, Leed Breeam. Per uso professionale.</p> | | <p>Breathable hypoallergenic water-based anti-condensation paint dermatologically tested with test report No. 263/14/04 (ISPE) certifying that it is harmless to humans and thus suitable to rooms accommodating allergy sufferers. The disruptive action of aldehydes is certified by Istituto Giordano certificate No. 326956. Classified TVOC A+, it complies with Leed Breeam protocols. For professional use.</p> | | <p>Pintura al agua al agua transpirante anticondensación ipoalergénica dermatológicamente testada con informe de prueba N.° 263/14/04 (ISPE) que certifica la no peligrosidad para el hombre, y por tanto la idoneidad para espacios frecuentados por sujetos sensibles a las alergias. La acción disgregante de los aldehídos está certificada por el Instituto Giordano N.° 326956. La Clase TVOC A+ la hace idónea para cumplir con los protocolos Leed Breeam. Para uso profesional.</p> | |
| <p>Attrezzatura: pennello, rullo, airless Diluizione: acqua - 5-10%; airless 15-20% Resa (2 mani): 3-3,5 m²/l - Per confezione (12 l): 42 m² Colore: solo bianco</p> | | <p>Equipment: brush, roller, airless Dilution: water - 5-10%; airless 15-20% Coverage (2 coats): 3-3,5 m²/l - Per packaging (12 l): 42 m² Color: only white</p> | | <p>Herramientas: brocha, rodillo, pistola pulverizadora Dilución: agua - 5-10%; pistola pulverizadora 15-20% Rendimiento (2 capas): 3-3,5 m²/l - Por envase (12 l): 42 m² Color: solo blanco</p> | |

| | | | |
|---|---------------------------------|--|-------------------|
| tecniche | certificazioni | proprietà | tecnologie |
| WATER BASED BRUSH ROLLER AIRLESS | A+ Allergico abbatte aldeidi | V1 BREATHABLE matt ANTI CONDENSATION | |

primer therm



scheda
tecnica



data
sheet



ficha
técnica

| | | | | | |
|--|------------------------|--|-----------------------|---|--------------------------|
| fissativo acrilico | interno esterno | acrylic fixative | indoor outdoor | fijador acrilico | interior exterior |
| <p>Fissativo acrilico all'acqua pigmentato, ad alto potere penetrante, idoneo per supporti leggermente assorbenti o sferinanti, particolarmente attivo in sinergia con Vita Therm per prevenire l'annerimento da muffe in parete. La Classe TVOC A+ lo rende idoneo per ottemperare ai protocolli CAM, Leed Breeam. Per uso professionale.</p> | | <p>Water-based pigmented acrylic fixative with great penetrating properties, suitable for slightly absorbent and chalky substrates. Particularly active with Vita Therm to prevent wall blackening due to mould. Classified TVOC A+, it complies with Leed Breeam protocols. For professional use.</p> | | <p>Fijador acrílico al agua, pigmentado, de alto poder penetrante, idóneo para soportes ligeramente absorbentes o con desintegración pulverulenta, particularmente activo en sinergia con el producto Vita Therm para prevenir el ennegrecimiento causado por mohos en la pared. La Clase TVOC A+ la hace idónea para cumplir con los protocolos Leed Breeam. Para uso profesional.</p> | |
| <p>Attrezzatura: pennello, rullo, airless Diluizione: acqua - 500% Resa (2 mani): 6-8 m²/l - Per confezione (12 l): 96 m² Colore: solo bianco</p> | | <p>Equipment: brush, roller, airless Dilution: water - 500% Coverage (2 coats): 6-8 m²/l - Per packaging (12 l): 96 m² Color: only white</p> | | <p>Herramientas: brocha, rodillo, pistola pulverizadora Dilución: agua - 500% Rendimiento (2 capas): 6-8 m²/l - Por envase (12 l): 96 m² Color: solo blanco</p> | |

| | | | |
|---|-----------------------|------------------|-------------------|
| tecniche | certificazioni | proprietà | tecnologie |
| WATER BASED BRUSH ROLLER AIRLESS | | | |

sana rasotherm

 scheda
tecnica

 data
sheet

 ficha
técnica

| rasante termico anticondensa | interno | anti-condensation thermal skim coat | indoor | enrasado térmico anticondensación | interiores |
|--|---------|---|--------|---|------------|
| <p>Rasante e intonaco in pasta con elevate proprietà termoisolanti a base di sfere di vetro cave e materie prime ad alta resistenza termica in grado di conferire al prodotto un valore di lambda estremamente basso. Migliora e riduce formazione di condensa superficiale con relativo sviluppo di muffe. Per uso professionale.</p> | | <p>Skim coat and plaster in paste form with high thermal insulating properties based on hollow glass beads and high thermal resistant raw materials that give the product an extremely low lambda value. It improves performance and reduces the formation of surface condensation, preventing the development of mould and mildew. For professional use.</p> | | <p>Enrasado y enfoscado en pasta con elevadas propiedades termoaislantes a base de bolas de vidrio huecas y materias primas de alta resistencia térmica capaces de conferir al producto un valor de lambda extremadamente bajo. Mejora y reduce la formación de condensación superficial con desarrollo de mohos. Para uso profesional.</p> | |
| <p>Attrezzatura: frattazzo dentato (denti da 12 mm), frattazzo metallico, spatola abrasiva Diluizione: acqua - pronto all'uso Resa: 6 l/m² per 6 mm di spessore Colore: solo bianco</p> | | <p>Equipment: toothed trowel (12 mm teeth), metal trowel, abrasive coat spatula Dilution: water - ready to use Coverage: 6 l/m² per 6 mm of thickness Color: only white</p> | | <p>Herramientas: llana dentada (dientes de 12 mm), llana metálica, espátula abrasiva Dilución: agua - listo para usar Rendimiento: 6 l/m² por 6 mm de espesor Color: solo blanco</p> | |

| tecniche | certificazioni | proprietà | tecnologie |
|---------------------------------------|----------------|------------|------------|
| WATER BASED TROWEL READY TO USE | | BREATHABLE | |

sana finish

 scheda
tecnica

 data
sheet

 ficha
técnica

| rasante di finitura a civile | interno esterno | skim coat with two- coat finish | indoor outdoor | enrasado para acabado de revoco | interior exterior |
|--|--------------------|--|-------------------|---|----------------------|
| <p>Rasatura a grana fine idonea per rasare intonaci cementizi vecchi (non sfarinanti) e nuovi. Lo spessore massimo per singola mano è di 3 mm; per ottenere spessori maggiori è necessario inserire tra la prima e la seconda mano una rete in fibra di vetro. Studiata come finitura a civile di Sana Rasotherm nel ciclo "Vita Sana". Per uso professionale.</p> | | <p>Fine-grained skim coat suitable for smoothing out old (non-flaking) and new cement-based plasters. The maximum thickness of a single coat is 3 mm; greater thicknesses require installing a glass fibre mesh between the first and second coat. Designed as a two-coat finish for Sana Rasotherm used in the "Vita Sana" process. For professional use.</p> | | <p>Enrasado de grano fino idóneo para enrasar enfoscados de cemento viejos (sin desintegración pulverulenta) y nuevos. El espesor máximo para una sola mano es de 3 mm; para obtener espesores mayores es necesario interponer una malla de fibra de vidrio. Estudiado como acabado de revoco de Sana Rasotherm en el ciclo "Vita Sana" Para uso profesional.</p> | |
| <p>Attrezzatura: spatola Rapporto di miscelazione: acqua - 24-25% Resa: 1,5 kg/m² per mm di spessore Colore: solo bianco</p> | | <p>Equipment: spatula Mixing ratio: water - 24-25% Coverage: 1,5 kg/m² per mm of thickness Color: only white</p> | | <p>Herramientas: espátula Proporción de mezcla: agua - 24-25% Rendimiento: 1,5 kg/m² per mm de espesor Color: solo blanco</p> | |

| tecniche | certificazioni | proprietà | tecnologie |
|-----------------------|----------------|------------|------------|
| WATER BASED TROWEL | | BREATHABLE | |

sana bianca

 scheda
tecnica

 data
sheet

 ficha
técnica

| idropittura traspirante antimuffa | interno | breathable water- based paint | indoor | pittura al acqua traspirante | interiores |
|---|---------|---|--------|--|------------|
| <p>Idropittura traspirante opaca a base di resine acriliche. La sua efficacia contro l'annerimento dovuto all'attacco di funghi e muffe è certificata dal documento N° 537/I eseguito dai laboratori di ricerca della GFC chimica. Per uso professionale.</p> | | <p>Matt breathable water-based paint with acrylic resins. Its effectiveness against the blackening produced by mould and mildew is certified by document No. 537/I issued by the GFC Chimica research laboratories. For professional use.</p> | | <p>Pittura al acqua traspirante mate a base de resinas acrilicas. Su eficacia contra el ennegrecimiento debido al ataque de hongos y mohos se certifica con el documento n.º 537/I realizado por los laboratorios de investigación de GFC química. Para uso profesional.</p> | |
| <p>Attrezzatura: pennello, rullo Diluizione: acqua - 15-20% Resa (2 mani): 4-5 m²/l - Per confezione (12 l): 60 m² Colore: bianco e colorato</p> | | <p>Equipment: brush, roller Dilution: water - 15-20% Coverage (2 coats): 4-5 m²/l - Per packaging (12 l): 60 m² Color: white and colored</p> | | <p>Herramientas: brocha, rodillo Dilución: agua - 15-20% Rendimiento (2 capas): 4-5 m²/l - Por envase (12 l): 60 m² Color: blanco y colorido</p> | |

| tecniche | certificazioni | proprietà | tecnologie |
|--|----------------|-------------------------------------|------------|
| COLOURABLE WATER BASED BRUSH ROLLER | muffe batteri | class 2 BREATHABLE BRILLIANCE | |

sanasil-bio



scheda
tecnica



data
sheet



ficha
técnica



| | | |
|--|---|--|
| idropittura traspirante a base silicati interno esterno | breathable water-based paint with silicates indoor outdoor | pintura al agua transpirante a base de silicatos interior exterior |
| Idropittura a base silicati, conforme alle normative DIN EN 13300 e DIN 18363 per il contenuto di sostanze organiche. Assicura traspirabilità al vapore, idrorepellenza e copertura. Formulata con bassissimo VOC e a film protetto dall'attacco di muffe e microorganismi. Per uso professionale. | Water-based paint containing silicates, compliant with DIN EN 13300 and DIN 18363 given its content of organic substances. Vapour permeable, water repellent, washable, it also provides good coverage. Formulated with very low VOC; film protected from the attack of mould and microorganisms. For professional use. | Pintura al agua a base de silicatos, conforme a las normativas DIN EN 13300 y DIN 18363 para el contenido de sustancias orgánicas. Asegura transpirabilidad al vapor, capacidad hidro-repelente y cubriente. Formulada con bajísimo VOC y en película protegida del ataque de mohos y microorganismos. Para uso profesional. |
| Attrezzatura: pennello, rullo, spruzzo Diluizione: acqua distillata - 20-30% Resa (2 mani): 4-4,5 m ² /l - Per confezione (12 l): 54 m ² Colore: solo bianco | Equipment: brush, roller, airless Dilution: distilled water - 20-30% Coverage (2 coats): 4-4,5 m ² /l - Per packaging (12 l): 54 m ² Color: only white | Herramientas: brocha, rodillo, pistola pulverizadora Dilución: agua destilada - 20-30% Rendimiento (2 capas): 4-4,5 m ² /l - Por envase (12 l): 54 m ² Color: solo blanco |

| | | | |
|---|-----------------------|---|-------------------|
| tecniche | certificazioni | proprietà | tecnologie |
| WATER BASED BRUSH ROLLER AIRLESS | | class 3 COVERAGE V1 BREATHABLE MINERAL matt BRILLIANCE | silicate 5 |

sana solux



scheda
tecnica



data
sheet



ficha
técnica



| | | |
|--|--|---|
| soluzione murale igienizzante interno esterno | sanitising wall solution indoor outdoor | solución de pared desinfectante interior exterior |
| Soluzione acquosa a base di particolari additivi indicata come igienizzante per supporti diversi con forte presenza di muffe, funghi e alghe. Per uso professionale. | Water-based solution containing special additives to be used as sanitiser for various substrates with an intense presence of mould, fungi and algae. For professional use. | Solución acuosa a base de aditivos particulares indicada como desinfectante de distintos soportes con presencia abundante de mohos, hongos y algas. Para uso profesional. |
| Attrezzatura: pennello, rullo, spruzzo Diluizione: acqua - 400% Resa prodotto diluito (1 mano): 40 m ² /l - per confezione (5 l): 250 m ² ca Colore: incolore | Equipment: brush, roller, airless Dilution: water - 400% Coverage (1 coat diluted product): 40 m ² /l - per packaging (5 l): 250 m ² ca Color: colourless | Herramientas: brocha, rodillo, pistola pulverizadora Dilución: agua - 400% Rendimiento (1 mano producto diluido): 40 m ² /l - Por envase (5 l): 250 m ² ca Color: incoloro |

| | | | |
|---|-----------------------|------------------|-------------------|
| tecniche | certificazioni | proprietà | tecnologie |
| WATER BASED BRUSH ROLLER AIRLESS | | | |

sana solux spray



scheda
tecnica



data
sheet



ficha
técnica



| | | |
|--|--|---|
| soluzione igienizzante interno esterno | sanitising solution indoor outdoor | solución desinfectante interior exterior |
| Soluzione acquosa igienizzante a base di principi attivi specifici per bonificare e risanare supporti murari con forte presenza di muffe, funghi e alghe. Per uso professionale. | Water-based sanitisation solution containing specific active ingredients to clean and restore masonry substrates with an intense presence of mould, fungi and algae. For professional use. | Solución acuosa desinfectante a base de principios activos específicos para el saneamiento y reacondicionamiento de soportes de pared con presencia abundante de mohos, hongos y algas. Para uso profesional. |
| Diluizione: pronto all'uso Resa (1 mano): 10 m ² /l - Per confezione (0,500 l): 5 m ² | Dilution: ready to use Coverage (1 coat): 10 m ² /l - Per packaging (0,500 l): 5 m ² | Dilución: listo para usar Rendimiento (1 capa): 10 m ² /l - Por envase (0,500 l): 5 m ² |

| | | | |
|-----------------------------|-----------------------|------------------|-------------------|
| tecniche | certificazioni | proprietà | tecnologie |
| WATER BASED READY TO USE | | | |

espositore prodotti vita sana



| | interno | indoor | interiores |
|----------------|---|---|--|
| | Espositore in cartonato, personalizzato Vita Sana, a 4 ripiani. | Life Sana custom cardboard display, with 4 shelves. | Expositor de cartón, personalizado Vita Sana, con 4 estantes. |
| Misure: | larghezza cm 114 altezza cm 215 profondità cm 37 | Measures: width cm 114 height cm 215 depth cm 37 | Medidas: ancho 114 cm altura 215 cm profundidad 37 cm |

totem promozionale vita sana



| | interno | indoor | interiores |
|----------------|---|---|--|
| | Totem espositivo promozionale, personalizzato Vita Sana, bifacciale in cartone a forma ellittica, completo di alette interne. | Promotional exhibition totem, custom Vista Sana, two-sided cardboard elliptical, complete with internal fins. | Tótem de exhibición promocional, Vista Sana personalizado, doble cara en cartón con forma elíptica, completo con solapas internas. |
| Misure: | larghezza cm 70 altezza cm 197 profondità cm 25 | Measures: width cm 70 height cm 197 depth cm 25 | Medidas: ancho 70 cm altura 197 cm profundidad 25 cm |



sana salute gel

 scheda
tecnica

 data
sheet

 ficha
técnica

| gel igienizzante mani | hand sanitiser | gel desinfectante para las manos |
|---|---|--|
| <p>Gel igienizzante mani realizzato con ingredienti che rispettano il film idrolipidico della pelle e che rilasciano una piacevole sensazione di idratazione sulle mani, è pratico da usare in ogni situazione. La sua particolare formula in gel permette una rapida azione ed un utilizzo senz'acqua. Conforme alla circolare del ministero della salute n° 5433 del 22/02/2020. Per uso professionale.</p> | <p>Hand sanitising gel made with ingredients that preserve the hydrolipidic film of the skin, imparting a pleasant, moisturising sensation. Practical for use in any situation. Its special gel formula ensures fast action and requires no water. Complies with Italian Ministry of Health Circular No. 5433 dated 22/02/2020. For professional use.</p> | <p>Gel desinfectante para las manos realizado con ingredientes que respetan la película hidrolipídica de la piel y que proporcionan una agradable sensación de hidratación en las manos, de uso práctico en toda situación. Su particular fórmula en gel permite una acción rápida y su uso sin agua. Conforme a la circular del ministerio de sanidad italiano n.º 5433 del 22/02/2020. Para uso profesional.</p> |
| <p>Diluizione: pronto all'uso Colore: incolore</p> | <p>Dilution: ready to use Color: colourless</p> | <p>Dilución: listo para usar Color: incoloro</p> |

| tecniche | certificazioni | proprietà | tecnologie |
|----------|----------------|-----------|------------|
| | | | |

sana salute spray

 scheda
tecnica

 data
sheet

 ficha
técnica

| igienizzante per attrezzature | equipment sanitiser | desinfectante para herramientas |
|---|---|--|
| <p>Igienizzante per attrezzature svolge sulle superfici un'efficace azione igienizzante, evaporando rapidamente senza lasciare traccia. Impiegabile su superfici, mobili, oggetti e attrezzature sensibili all'acqua. Risciacquare le superfici trattate che vanno a contatto con gli alimenti. Pronto all'uso. Conforme alla circolare del ministero della salute n° 5433 del 22/02/2020. Per uso professionale.</p> | <p>Equipment sanitiser to effectively sanitise surfaces. It evaporates quickly without leaving a trace. Suitable for use on surfaces such as furniture, objects and equipment that are sensitive to water. Rinse any treated surfaces that come into contact with food-stuffs. Ready to use. Complies with Italian Ministry of Health Circular No. 5433 dated 22/02/2020. For professional use.</p> | <p>Desinfectante para herramientas; ejerce en las superficies una eficaz acción desinfectante; se evapora rápidamente sin dejar rastro. Puede emplearse sobre superficies muebles, objetos y herramientas sensibles al agua. Enjuagar las superficies tratadas que entren en contacto con los alimentos. Listo para usar. Conforme a la circular del ministerio de sanidad italiano n.º 5433 del 22/02/2020. Para uso profesional.</p> |
| <p>Diluizione: pronto all'uso Colore: incolore</p> | <p>Dilution: ready to use Color: colourless</p> | <p>Dilución: listo para usar Color: incoloro</p> |

| tecniche | certificazioni | proprietà | tecnologie |
|----------|----------------|-----------|------------|
| | | | |

sana salute pro indoor

 scheda
tecnica

 data
sheet

 ficha
técnica

| detergente igienizzante per superfici interne | interno | sanitising detergent for indoor surfaces | indoor | detergente desinfectante para superficies interiores | interiores |
|---|---------|---|--------|--|------------|
| <p>Detergente igienizzante per superfici interne particolarmente efficace per pulire pavimenti, sanitari, rubinetterie, bidoni dei rifiuti e superfici lucide e perfettamente deterse. Viene normalmente utilizzato ovunque ci siano esigenze di pulizia radicale eliminando anche eventuali cattivi odori. Conforme alla circolare del ministero della salute n° 5433 del 22/02/2020. Per uso professionale.</p> | | <p>Sanitising detergent for indoor surfaces that is particularly effective for cleaning floors, bathroom fixtures, taps, garbage cans and shiny, perfectly clean surfaces. It is normally used whenever radical cleaning is needed while also eliminating any unpleasant odours. Complies with Italian Ministry of Health Circular No. 5433 dated 22/02/2020. For professional use.</p> | | <p>Detergente desinfectante para superficies interior particolarmente eficaz para limpiar suelos, sanitarios, grifería, bidones de residuos y superficies brillantes y perfectamente limpias. Normalmente se utiliza allí donde existan necesidades de limpieza radical, eliminando también los malos olores. Conforme a la circular del ministerio de sanidad italiano n.º 5433 del 22/02/2020. Para uso profesional.</p> | |
| <p>Attrezzatura: Sana Salute Sprayer Pump, spugna, panno Diluizione: 50 ml di prodotto in 1l di acqua Colore: incolore</p> | | <p>Equipment: Sana Salute Sprayer Pump, sponge, cloth Dilution: 50 ml of product in 1l of water Color: colourless</p> | | <p>Herramientas: aparato pulverizador, nebulizador, esponja, paño Dilución: 50 ml de producto in 1l di agua Color: incoloro</p> | |

| tecniche | certificazioni | proprietà | tecnologie |
|----------|----------------|-----------|------------|
| | | | |

sana salute pro outdoor



scheda
tecnica



data
sheet



ficha
técnica



| | | | | | |
|---|----------------|---|----------------|--|-----------------|
| detergente igienizzante per superfici esterne | esterno | sanitising detergent for outdoor surfaces | outdoor | detergente desinfettante para superficies exteriores | exterior |
| Detergente igienizzante, sgrassante e sanificante cloro attivo per superfici esterne. La sua formulazione risulta particolarmente efficace per l'igienizzazione di strade, marciapiedi, parcheggi, ponteggi viali e vialetti. Conforme alla circolare del ministero della salute n° 5433 del 22/02/2020. Per uso professionale. | | Active chlorine-based sanitising, degreasing detergent for outdoor surfaces. Its formulation is particularly effective in sanitising roads, sidewalks, parking lots, scaffolding, footpaths and driveways. Complies with Italian Ministry of Health Circular No. 5433 dated 22/02/2020. For professional use. | | Detergente desinfettante, desengrasante y saneador de cloro activo para superficies exteriores. Su formulación resulta particularmente eficaz para la desinfección de calles, aceras, aparcamientos, andamios, avenidas y callejones. Conforme a la circular del ministerio de sanidad italiano n.° 5433 del 22/02/2020. Para uso profesional. | |
| Attrezzatura: Sana Salute Sprayer Pump Diluizione: 2 l di prodotto in 100 l di acqua Colore: incolore | | Equipment: Sana Salute Sprayer Pump Dilution: 2 l of product in 100 l of water Color: colourless | | Herramientas: Sana Salute Sprayer Pump Dilución: 2 l de producto in 100 l di agua Color: incoloro | |

| tecniche | | | certificazioni | | | proprietà | | | tecnologie | | |
|----------|--|--|----------------|--|--|-----------|--|--|------------|--|--|
| | | | | | | | | | | | |

sana salute oxy



scheda
tecnica



data
sheet



ficha
técnica



| | | | | | |
|--|------------------------|--|-----------------------|--|--------------------------|
| igienizzante per utensili a contatto con alimenti | interno esterno | sanitiser for utensils in contact with foodstuffs | indoor outdoor | desinfettante para utensilios en contacto con alimentos | interior exterior |
| Igienizzante per utensili a contatto con alimenti a base di perossido d'idrogeno stabilizzato e sali quaternari d'ammonio ad ampio spettro d'azione. Conforme alla normativa H.A.C.C.P. per l'utilizzo su attrezzature e superfici a contatto con alimenti. Esplica una notevole azione deodorante, conforme alla circ. 5443 del 22/02/2020 del Ministero della salute su prodotti idonei ad eliminare il nuovo Coronavirus (SARS-CoV-2). Per uso professionale. | | Broad spectrum sanitiser for utensils in contact with foodstuffs based on stabilised hydrogen peroxide and quaternary ammonium salts. Complies with H.A.C.C.P. regulations on equipment and surfaces in contact with foodstuffs. It has a remarkable deodorising action, in accordance with Ministry of Health circular 5443 of 22/02/2020 concerning products able to eliminate the new Coronavirus (SARS-CoV-2). For professional use. | | Desinfettante para utensilios en contacto con alimentos a base de peróxido de hidrógeno estabilizado y sales cuaternarias de amonio de amplio espectro de acción. Conforme a la normativa H.A.C.C.P. para el uso sobre herramientas y superficies en contacto con alimentos. Ejerce una notable acción desodorante, conforme a la circular 5443 del 22/02/2020 del Ministerio de sanidad italiano sobre los productos idóneos para eliminar el nuevo Coronavirus (SARS-CoV-2). Para uso profesional. | |
| Attrezzatura: Sana Salute Sprayer Pump, spugna, panno Diluizione: pronto all'uso o diluito al 60% con acqua Colore: incolore | | Equipment: Sana Salute Sprayer Pump, sponge, cloth Dilution: ready to use or diluted at 60% with water Color: colourless | | Herramientas: aparato pulverizador, nebulizador, esponja, paño Dilución: listo para usar o dilucion al 60% con agua Color: incoloro | |

| tecniche | | | | certificazioni | | | proprietà | | | tecnologie | | |
|----------|--|--|--|----------------|--|--|-----------|--|--|------------|--|--|
| | | | | | | | | | | | | |

sana salute sprayer pump



| | | |
|--|--|---|
| Nebulizzatore a batteria elettrica al litio per detergenti igienizzanti Virus-stop Indoor e Outdoor. | Lithium electric battery nebulizer for Virus-stop Indoor and Outdoor sanitizers. | Nebulizador eléctrico de batería de litio para detergentes desinfectantes para interior y exteriores Virus-stop |
| Capacità: 8 litri | Capacity: 8 liters | Capacità: 8 litros |

colonna porta gel

| | | |
|---|---|---|
| Colonna espositore per Sana Salute Gel 500 ml | Display column for Sana Salute Gel 500 ml | Column expositora para Sana Salute Gel 500 ml |
|---|---|---|



| | prodotto | caratteristiche principali | destinazione d'uso |
|---------------------|--|--|--------------------|
| BEST SELLERS | traspicolor active pag. 16 | idropittura traspirante antimuffa certificata | interno |
| | enjoy 1 coat pag. 17 | idropittura lavabile a mano unica | interno |
| IDROSMALTI | idromatt pag. 20 | Idrosmalto opaco murale | interno / esterno |
| | idrosatin pag. 20 | Idrosmalto satinato murale | interno / esterno |
| | idrogloss pag. 21 | Idrosmalto lucido murale | interno / esterno |
| LAVABILI | clean matt pag. 24 | idropittura superlavabile smacchiabile agli ioni d'argento | interno |
| | luxury pag. 24 | idropittura superlavabile opaca | interno / esterno |
| | tech active pag. 25 | idropittura lavabile opaca mascherante antimuffa | interno |
| | sol-tex pag. 25 | idropittura lavabile riempitiva | interno |
| IDROPITTURE | silan tech pag. 28 | idropittura traspirante acrisilossanica antimuffa | interno |
| | traspinterno pag. 28 | idropittura traspirante universale | interno |
| | white cream pag. 29 | idropittura traspirante effetto vellutato | interno |
| | mural verde pag. 29 | idropittura murale traspirante opaca | interno |
| PITTURE | mural blu pag. 32 | idropittura murale traspirante coprente | interno |
| | pittura per interni extra pag. 32 | idropittura murale traspirante tinte tenui | interno |
| | biancocalce pag. 33 | pittura a base di grassello di calce | interno |
| | bianco interno pag. 33 | idropittura murale coprente opaca | interno |
| | idroflex matt pag. 34 | Idropittura a spessore plastico bucciato | interno |
| | idroflex gloss pag. 34 | idropittura a spessore plastico lavabile | interno |
| | idrofumo pag. 35 | pittura opaca antifumo | interno |
| VITA SANA | vita bianca pag. 38 | idropittura traspirante ipoallergenica | interno |
| | vita wash pag. 38 | idropittura lavabile ipoallergenica | interno |
| | vita therm pag. 39 | idropittura traspirante anticondensa | interno |
| | sana bianca pag. 40 | idropittura traspirante antimuffa | interno |
| | sanasil-bio pag. 41 | idropittura traspirante a base silicati | interno |

| colori | traspirabilità | copertura | lavabilità | brillantezza | altre proprietà | tecnologie | certificazioni |
|-----------|----------------|-----------|------------|--------------|-----------------|--------------|----------------------------------|
| bianco | V1 | class 2 | S3 | matt | --- | active | A+; muffe e batteri |
| YouColor® | V1 | class 1 | S3 | matt | pronto uso | --- | A+ |
| YouColor® | V3 | --- | S1 | matt | --- | resistance 5 | A+; HACCP |
| YouColor® | V3 | --- | S1 | satin | --- | resistance 5 | A+; HACCP |
| YouColor® | V3 | --- | S1 | gloss | --- | resistance 5 | A+; HACCP |
| YouColor® | V3 | class 1 | S1 | matt | cleanable | clean | A+; HACCP |
| YouColor® | --- | class 1 | S1 | matt | --- | --- | A+ |
| YouColor® | --- | class 2 | S2 | matt | --- | active | A+ |
| YouColor® | V2 | class 2 | S3 | matt | --- | --- | A+ |
| YouColor® | V1 | class 2 | S3 | matt | --- | siloxan 4 | --- |
| YouColor® | V1 | class 3 | --- | matt | --- | --- | --- |
| bianco | V1 | class 1 | --- | matt | --- | --- | A+ |
| YouColor® | V1 | class 2 | --- | matt | --- | --- | --- |
| bianco | V1 | class 3 | --- | matt | --- | --- | --- |
| colorato | V1 | class 3 | --- | matt | base calce | --- | --- |
| bianco | V1 | class 4 | --- | matt | --- | --- | --- |
| bianco | V1 | class 4 | --- | matt | --- | --- | --- |
| colorato | --- | --- | S3 | matt | pronto uso | resistance 4 | --- |
| colorato | --- | --- | S3 | satin | pronto uso | resistance 4 | --- |
| bianco | --- | class 4 | S3 | satin | --- | --- | --- |
| bianco | V1 | class 1 | --- | matt | --- | --- | A+; anallergico; abbatte aldeidi |
| YouColor® | V2 | class 2 | S3 | matt | --- | --- | A+; anallergico; abbatte aldeidi |
| bianco | V1 | class 2 | --- | matt | anticondensa | --- | A+; anallergico; abbatte aldeidi |
| YouColor® | V1 | class 2 | --- | matt | --- | --- | muffe e batteri |
| YouColor® | V1 | class 3 | --- | matt | mineral | silicate 5 | |

anti-muffa - anti-mold - antimoho

| | | |
|---------------------------------------|---|---|
| risanamento restoration acabado | consolidamento / imprimitura consolidation/ priming consolidación / imprimación | finitura finish acabado |
| sana solux pag.41 | acrilica 100 (opzionale) pag.81 | traspicolor active pag.16 oppure tech activ pag.25 oppure sana bianca pag.40 |

anti-condensa - anti-condensation - anticondensación

| | | |
|---------------------------------------|---|-------------------------------|
| risanamento restoration acabado | consolidamento / imprimitura consolidation/ priming consolidación / imprimación | finitura finish acabado |
| sana solux pag.41 | primer therm pag.39 | vita therm pag.39 |

termico, anti-condensa - thermal, anti-condensation - termico, anticondensación

| | | | | |
|---------------------------------------|---|---------------------------------|--|---|
| risanamento restoration acabado | consolidamento / imprimitura consolidation/ priming consolidación / imprimación | rasante skim coat rasante | rasante di finitura skim coat of finish rasante de acabado | finitura finish acabado |
| sana solux (opzionale) pag.41 | primer therm pag.39 | sana rasotherm pag.40 | sana finish pag.40 | vita therm pag.39 oppure sana bianca pag.40 |

cartongesso - plasterboard - panel de yeso

| | | | |
|---|--|------------------------------|--|
| consolidamento / imprimitura consolidation/ priming consolidación / imprimación | rasante per giunti skim coat for joint rasante de juntas | fondo undercoat fondos | finitura finish acabado |
| acrilica 100 (opzionale) pag.81 | elastucco (opzionale) pag.84 | prime tech pag.76 | enjoy 1 coat pag.17 oppure traspicolor active pag.16 oppure tech active pag.25 oppure prodotti delle linee lavabili o idrosmalti |

uniformante - unifying - uniformando

| | | |
|---|--|---|
| consolidamento / imprimitura consolidation/ priming consolidación / imprimación | strato uniformante uniforming layer capa uniformadora | finitura finish acabado |
| acrilica 100 pag.81 | rasofondo color pag.76 oppure rasofondo flex pag.77 | luxury pag.24 oppure silan tech pag.28 oppure sol-tex pag.25 |

contatto con alimenti (HACCP) - food contact - contacto con alimentos

| | |
|---|--|
| consolidamento / imprimitura consolidation/ priming consolidación / imprimación | finitura finish acabado |
| primacril pag.80 | idrogloss pag.21 oppure idromatt pag.20 oppure idrosatin pag.20 |

smacchiabile - stain-removal - quitamanchas

| | | |
|---|---|--|
| consolidamento / imprimitura consolidation/ priming consolidación / imprimación | finitura (opzione 1) finish (option 1) acabado (opción 1) | finitura (opzione 2) finish (option 2) acabado (opción 2) |
| acrilica 100 pag.81 oppure primacril pag.80 | clean matt pag.24 | idrogloss pag.21 oppure idromatt pag.20 oppure idrosatin pag.20 |

minerale - mineral - mineral

| | | |
|---|---|--|
| consolidamento / imprimitura consolidation/ priming consolidación / imprimación | strato uniformante uniforming layer capa uniformadora | finitura finish acabado |
| ivasil primer s pag.81 | ivasil fondo (opzionale) pag.77 | biancocalce pag.33 oppure old time paint (Metropolis) |

paints

pitture high tech per esterno

prodotti

silox plus

superquarz plus

ultra dry

superclean plus

superquarz plus strong

superquarz plus reflect

ivasgum side finish

quarzogum plus

idrobeton

ivasil pittura

deco sand plus

ivaglass

betonglass



ht

silox plus

scheda
tecnicadata
sheetficha
técnica

| idropittura polisilossanica a effetto vellutato | esterno | water-based polysiloxane paint with velvety effect | outdoor | pintura al agua polisiloxánica de efecto aterciopelado | exterior |
|---|---------|--|---------|--|----------|
| Idropittura a base di resine polisilossaniche e cariche bilanciate, assicura elevata traspirabilità e bassissimo assorbimento d'acqua. La caratteristica formulazione conferisce semplicità di applicazione. Forma un film resistente all'attacco di alghe, funghi e muffe, grazie ad un'innovativa formulazione che prevede additivi a largo spettro certificata dal Fraunhofer-Institut für Bauphysik di Monaco. La Classe TVOC A+ lo rende idoneo per ottemperare ai protocolli CAM, Leed Breeam. Per uso professionale. | | Water-based paint containing polysiloxane resins and balanced fillers, ensuring high breathability and very low water absorption. The characteristic formulation makes it easy to apply. Produces a mould-, algae-, and fungi-resistant film using an innovative formulation based on broad spectrum additives certified by Fraunhofer-Institut für Bauphysik of Munich. Classified TVOC A+, it complies with Leed Breeam protocols. For professional use. | | Pintura al agua a base de resinas polisiloxánicas y cargas equilibradas, asegura una elevada transpirabilidad y una absorción de agua muy baja. Su formulación característica la hace de fácil aplicación. Forma una película resistente al ataque de algas, hongos y mohos, gracias a una innovadora formulación que incluye aditivos de amplio espectro certificada por el Fraunhofer-Institut für Bauphysik de Munich. La Clase TVOC A+ la hace idónea para cumplir con los protocolos Leed Breeam. Para uso profesional. | |
| Attrezzatura: pennello, rullo, airless Diluizione: acqua - 1°mano: 20-30% - 2°mano: 15-20% Resa (2 mani): 3-4 m ² /l - Per confezione (14 l): 56 m ² Colore: bianco e colorato | | Equipment: brush, roller, airless Dilution: water - 1°coat: 20-30% - 2°coat: 15-20% Coverage (2 coats): 3-4 m ² /l - Per packaging (14 l): 56 m ² Color: white and colored | | Herramientas: brocha, rodillo, pistola pulverizadora Dilución: agua - 1°capa: 20-30% - 2°capa: 15-20% Rendimiento (2 capas): 3-4 m ² /l - Por envase (14 l): 56 m ² Color: blanco y colorido | |

| tecniche | certificazioni | proprietà | tecnologie |
|----------|----------------|-----------|------------|
| | | | |

superquarz plus

scheda
tecnicadata
sheetficha
técnica

| idropittura acrisilossanica | esterno | water-based acrylic- siloxane paint | outdoor | pintura al agua acrisiloxánica | exterior |
|--|---------|--|---------|--|----------|
| Idropittura acrisilossanica idrorepellente, traspirante, ad elevata resistenza agli agenti atmosferici ed allo sfarinamento, resiste all'alcalinità del supporto. Forma un film resistente all'attacco di alghe, funghi e muffe, grazie all'innovativa formulazione con additivi a largo spettro certificata dal Fraunhofer-Institut für Bauphysik di Monaco. La Classe TVOC A+ lo rende idoneo per ottemperare ai protocolli CAM, Leed Breeam. Per uso professionale. | | Acrylsilossanic water-based paint breathable, high resistance to weathering and crumbling, resists the alkalinity of the support. It forms a film resistant to algae, fungi and moulds, thanks to the innovative formulation with wide-ranging additives certified by the Fraunhofer-Institut für Bauphysik of Munich. Classified TVOC A+, it complies with Leed Breeam protocols. For professional use. | | Hidropintura acrisiloxánica repelente al agua, transpirable, de elevada resistencia a los agentes atmosféricos y al deshielo, resiste a la alcalinidad del soporte. Forma una película resistente al ataque de algas, hongos y mohos, gracias a la innovadora formulación con aditivos de amplio espectro certificada por el Fraunhofer-Institut für Bauphysik de Munich. La Clase TVOC A+ la hace idónea para cumplir con los protocolos Leed Breeam. Para uso profesional. | |
| Attrezzatura: pennello, rullo, airless Diluizione: acqua - prima mano: 20-30%, seconda mano: 15-20% Resa (2 mani): 3-4 m ² /l - Per confezione (14 l): 56 m ² Colore: bianco e colorato | | Equipment: brush, roller, airless Dilution: water - 1°coat: 20-30%, 2°coat: 15-20% Coverage (2 coats): 3-4 m ² /l - Per packaging (14 l): 56 m ² Color: white and colored | | Herramientas: brocha, rodillo, pistola pulverizadora Dilución: agua - 1° capa: 20-30%, 2° capa: 15-20% Rendimiento (2 capas): 3-4 m ² /l - Por envase (14 l): 56 m ² Color: blanco y colorido | |

| tecniche | certificazioni | proprietà | tecnologie |
|----------|----------------|-----------|------------|
| | | | |

ultra dry



scheda
tecnica



data
sheet



ficha
técnica



| | | | | | |
|--|----------------|--|----------------|---|-----------------|
| pittura idrorepellente protettiva | esterno | protective water repellent paint | outdoor | pintura hidro- repelente protectora | exterior |
| <p>Pittura liscia con tecnologia Dry che crea una barriera impenetrabile all'acqua, che non viene assorbita ma scorre sulla superficie, prevenendo in questa maniera l'accumulo di sporco e riducendo al minimo il deterioramento del film del prodotto. Questa particolare formulazione conferisce elevata resistenza agli agenti atmosferici e agli inquinanti trasportati dall'acqua. Per esterno. Per uso professionale.</p> | | <p>Smooth paint which uses a Dry technology to create a barrier that water cannot penetrate, thus water is not absorbed but flows over the surface. This prevents the accumulation of dirt and minimises deterioration of the film. This particular formulation imparts high resistance to the weather and water-borne pollutants. For professional use.</p> | | <p>Pintura lisa con tecnología Dry que crea una barrera impenetrable al agua, que no es absorbida, sino que resbala por la superficie, previniendo de ese modo la formación de suciedad y reduciendo al mínimo el deterioro de la película de producto. Esta particular formulación le proporciona una gran resistencia a los agentes atmosféricos y a los contaminantes transportados por el agua. Para uso profesional.</p> | |
| <p>Attrezzatura: pennello, rullo, airless Diluizione: acqua - max 10% Resa (2 mani): 4-4,5 m²/l - Per confezione (14 l): 63 m² Colore: bianco e colorato</p> | | <p>Equipment: brush, roller, airless Dilution: water - max 10% Coverage (2 coats): 4-4,5 m²/l - Per packaging (14 l): 63 m² Color: white and colored</p> | | <p>Herramientas: brocha, rodillo, pistola pulverizadora Dilución: agua - max 10% Rendimiento (2 capas): 4-4,5 m²/l - Por envase (14 l): 63 m² Color: blanco y colorido</p> | |

| | | | |
|-----------------|-----------------------|------------------|-------------------|
| tecniche | certificazioni | proprietà | tecnologie |
| | | | |

superclean plus



scheda
tecnica



data
sheet



ficha
técnica



| | | | | | |
|---|----------------|--|----------------|--|-----------------|
| idropittura autopulente ad effetto fotocatalitico | esterno | self-cleaning water- based paint with photocatalytic effect | outdoor | pittura al acqua autolimpiaadora de effetto fotocatalitico | exterior |
| <p>Idropittura a base di resine polisilossaniche, formulata con tecnologia nanometrica Clean atta a generare un effetto fotocatalitico ossidante in grado di decomporre le sostanze organiche che vengono a contatto con la superficie conferendo al film funzione autopulente. Aspetto opaco vellutato, insensibile all'alcalinità del supporto; idrorepellente. Per uso professionale</p> | | <p>Water-based paint containing polysiloxane resins, formulated using nanometre Clean technology in which oxidizing photocatalysis breaks down the organic substances in contact with the surface, giving the film self-cleaning properties. Velvety matt appearance, insensitive to the alkalinity of the substrate; water-repellent. For professional use.</p> | | <p>Pintura al agua a base de resinas polisiloxánicas, formulada con tecnología nanométrica Clean que genera un efecto fotocatalítico oxidante capaz de descomponer las sustancias orgánicas que entran en contacto con la superficie y proporciona a la película una función autolimpiadora. Aspecto mate aterciopelado, insensible a la alcalinidad del soporte; hidro-repelente. Para uso profesional.</p> | |
| <p>Attrezzatura: pennello, rullo, airless Diluizione: acqua - 1°mano: 20-30%; 2°mano: 15-20% Resa (2 mani): 3-4 m²/l - Per confezione (14 l): 56 m² Colore: bianco e colorato</p> | | <p>Equipment: brush, roller, airless Dilution: water - 1°coat: 20-30%; 2°coat: 15-20% Coverage (2 coats): 3-4 m²/l - Per packaging (14 l): 56 m² Color: white and colored</p> | | <p>Herramientas: brocha, rodillo, pistola pulverizadora Dilución: agua - 1°capa: 20-30%; 2°capa: 15-20% Rendimiento (2 capas): 3-4 m²/l - Por envase (14 l): 56 m² Color: blanco y colorido</p> | |

| | | | |
|-----------------|-----------------------|------------------|-------------------|
| tecniche | certificazioni | proprietà | tecnologie |
| | | | |

superquarz plus strong

scheda
tecnicadata
sheetficha
técnica

| idropittura per colori intensi | esterno | water-based paint for intense colours | outdoor | pintura al agua para colores intensos | exterior |
|--|---------|--|---------|--|----------|
| Idropittura a base di resine in dispersione acquosa e pigmenti basati su tecnologia Strong che conferiscono al film elevata resistenza alla luce e possibilità di ottenere una vasta gamma di colori intensi e dal tono estremamente vivo. Di aspetto opaco, a basso assorbimento d'acqua, possiede elevata resistenza agli agenti atmosferici e allo sfarinamento. Resistente all'attacco di alghe, funghi e muffe. Per uso professionale | | Water-based with balanced particle size fillers containing resins dispersed in water and pigments based on Strong technology. Makes it possible to obtain a wide range of intense colours with very vibrant tones. Matt finish and low water absorption. High resistance to the weather and chalking. Resistant to algae, fungi, mould and mildew. For professional use. | | Pintura al agua a base de resinas en dispersión acuosa y pigmentos basados en la tecnología Strong que proporciona a la película una gran resistencia a la luz y la posibilidad de obtener una amplia gama de colores intensos y de tono extremadamente vivo. De aspecto mate, de baja absorción de agua, posee una gran resistencia a los agentes atmosféricos y a la desintegración pulverulenta. Resistente al ataque de algas, hongos y mohos. Para uso profesional. | |
| Attrezzatura: pennello, rullo, airless Diluizione: acqua - 15-20% Resa (2 mani): 3-4 m ² /l - Per confezione (14 l): 56 m ² Colore: bianco e colorato | | Equipment: brush, roller, airless Dilution: water - 15-20% Coverage (2 coats): 3-4 m ² /l - Per packaging (14 l): 56 m ² Color: white and colored | | Herramientas: brocha, rodillo, pistola pulverizadora Dilución: agua - 15-20% Rendimiento (2 capas): 3-4 m ² /l - Por envase (14 l): 56 m ² Color: blanco y colorido | |

| tecniche | certificazioni | proprietà | tecnologie |
|--|----------------|--|--|
|  COLOURABLE  WATER BASED  BRUSH  ROLLER  AIRLESS | |  BREATHABLE |  plus  strong |

superquarz plus reflect

scheda
tecnicadata
sheetficha
técnica

| idropittura riflettente | esterno | reflective water-based paint | outdoor | pintura al agua reflectante | exterior |
|---|---------|--|---------|--|----------|
| Idropittura a base di resine in dispersione acquosa e "cool pigment" basati su tecnologia Reflect (Total Solar Reflectance) che permettono di realizzare colori dalle tonalità scure, limitando il riscaldamento eccessivo del film superficiale. Finitura opaca vellutata, insensibile all'alcalinità del supporto; idrorepellente e traspirante. Resistente all'attacco di alghe, funghi e muffe. Per uso professionale | | Acryl water-based paint with balanced particle size fillers dispersed in water and "cool pigments" based on Reflect technology (Total Solar Reflectance). It can be used to create colours with dark tones, keeping excessive heating of the surface film to a minimum. Velvety matt finish, insensitive to the alkalinity of the substrate; water-repellent. Resistant to algae, fungi, mould and mildew. For professional use. | | Pintura al agua a base de resinas en dispersión acuosa y "cool pigment" basados en la tecnología Reflect (Total Solar Reflectance) que permiten realizar colores de tonalidades oscuras limitando al mismo tiempo el calentamiento excesivo de la película superficial. Acabado mate aterciopelado, insensible a la alcalinidad del soporte; hidro-repellente y transpirante. Resistente al ataque de algas, hongos y mohos. Para uso profesional. | |
| Attrezzatura: pennello, rullo, airless Diluizione: acqua - prima mano: 20-30%, seconda mano: 15-20% Resa (2 mani): 3-4 m ² /l - Per confezione (14 l): 56 m ² Colore: bianco e colorato | | Equipment: brush, roller, airless Dilution: water - 1° coat: 20-30%, 2° coat: 15-20% Coverage (2 coats): 3-4 m ² /l - Per packaging (14 l): 56 m ² Color: white and colored | | Herramientas: brocha, rodillo, pistola pulverizadora Dilución: agua - 1° capa: 20-30%, 2° capa: 15-20% Rendimiento (2 capas): 3-4 m ² /l - Por envase (14 l): 56 m ² Color: blanco y colorido | |

| tecniche | certificazioni | proprietà | tecnologie |
|--|----------------|--|---|
|  WATER BASED  BRUSH  ROLLER  AIRLESS | |  BREATHABLE |  plus  reflect |

ivasgum side finitura



scheda
tecnica



data
sheet



ficha
técnica



| elastomerica | esterno | elastomeric paint | outdoor | pintura elastomérica | exterior |
|---|---------|--|---------|---|----------|
| <p>Pittura elastomerica extrafine a base di cariche inerti disperse in resine elastiche che conferiscono elevata elasticità e impermeabilità all'acqua, anche a bassi spessori. Idonea come finitura per ciclo elastomerico Ivas per superfici microfessurate. Forma una barriera alla penetrazione della CO₂ sul cemento armato a vista. Per uso professionale.</p> | | <p>Extra-fine elastomeric paint containing inert fillers dispersed in elastic resins that provide high elasticity and water resistance, even in thin coats. Suitable as topcoat for Ivas elastomeric process for surfaces with micro-cracks. Forms a barrier against the penetration of CO₂ into exposed reinforced concrete. For professional use.</p> | | <p>Pintura elastomérica extrafina a base de cargas inertes dispersas en resinas elásticas que proporcionan una gran elasticidad e impermeabilidad al agua, incluso con espesores bajos. Idónea como acabado para ciclo elastomérico Ivas para superficies microfisuradas. Forma una barrera contra la penetración del CO₂ en el cemento armado a la vista. Para uso profesional.</p> | |
| <p>Attrezzatura: pennello, rullo a pelo corto, airless Diluizione: acqua - 10-15% Resa (2 mani): 4-5 m²/l - Per confezione (14 l): 70 m² Colore: bianco e colorato</p> | | <p>Equipment: brush, roller, airless Dilution: water - 10-15% Coverage (2 coats): 4-5 m²/l - Per packaging (14 l): 70 m² Color: white and colored</p> | | <p>Herramientas: brocha, rodillo a pelo corto, pistola pulverizadora Dilución: agua - 10-15% Rendimiento (2 capas): 4-5 m²/l - Por envase (14 l): 70 m² Color: blanco y colorido</p> | |

| tecniche | certificazioni | proprietà | tecnologie |
|----------|----------------|-----------|------------|
| | | | |

quarzogum plus



scheda
tecnica



data
sheet



ficha
técnica



| pittura elastomerica riempitiva al quarzo | esterno | elastomeric paint with quartz fillers | outdoor | pintura elastomérica de relleno con cuarzo | exterior |
|---|---------|---|---------|---|----------|
| <p>Pittura riempitiva al quarzo alcaliresistente a base di resine elastomeriche, inerti, e sabbie in dispersione acquosa. La caratteristica elastica la rende idonea come finitura per cicli elastomerici anticavillature e la rende impermeabile ed altamente resistente alla presa di sporco. A film protetto dall'attacco di alghe, muffe e microorganismi. Per uso professionale.</p> | | <p>Paint with quartz filler based on elastomeric resins, inert material and sands dispersed in water. Its elastic properties make it suitable as crack-preventing topcoat for elastomeric processes and renders it both waterproof and highly resistant to dirt retention. The product film protects against algae, mould and microorganisms. For professional use.</p> | | <p>Pintura de relleno con cuarzo, resistente a los álcalis, a base de resinas elastoméricas, áridos y arenas en dispersión acuosa. Su característica elástica la hace idónea como acabado para ciclos elastoméricos anticuarteados, la hace impermeable y le proporciona una gran resistencia a la retención de suciedad. Forma una película protectora contra el ataque de algas, mohos y microorganismos. Para uso profesional.</p> | |
| <p>Attrezzatura: pennello, rullo a pelo corto, airless Diluizione: acqua - 15-20% Resa (2 mani): 4-5 m²/l - Per confezione (14 l): 70 m² Colore: bianco e colorato</p> | | <p>Equipment: brush, roller, airless Dilution: water - 15-20% Coverage (2 coats): 4-5 m²/l - Per packaging (14 l): 70 m² Color: white and colored</p> | | <p>Herramientas: brocha, rodillo a pelo corto, pistola pulverizadora Dilución: agua - 15-20% Rendimiento (2 capas): 4-5 m²/l - Por envase (14 l): 70 m² Color: blanco y colorido</p> | |

| tecniche | certificazioni | proprietà | tecnologie |
|----------|----------------|-----------|------------|
| | | | |

idrobeton

scheda
tecnicadata
sheetficha
técnica

| pittura anticarbonatazione | interno esterno | anti-carbonation paint | indoor outdoor | pintura anticarbonatación | interior exterior |
|--|-----------------|--|----------------|--|-------------------|
| <p>Pittura acrilica anticarbonatante particolarmente idonea per il trattamento del calcestruzzo a vista. Possiede un elevato potere penetrante ed elevato effetto barriera alla penetrazione dei gas, CO₂ e SO₂. Permeabilità all'anidride carbonica (EN 1062): Sd 200,29m; Classe C1. La Classe TVOC A+ lo rende idoneo per ottemperare ai protocolli CAM, Leed Breeam. Per uso professionale</p> | | <p>Acrylic anti-carbonation paint, particularly suited to the treatment of exposed concrete. It offers high penetrating power and high barrier effect against the penetration of gases, CO₂ and SO₂. Permeability to carbon dioxide (EN 1062): Sd 200,29m; Class C1. Classified TVOC A+, it complies with Leed Breeam protocols. For professional use.</p> | | <p>Pintura acrílica anticarbonatante particularmente adecuada para el tratamiento del hormigón a la vista. Posee un elevado poder penetrante y elevado efecto barrera contra la penetración de gases, CO₂ y SO₂. Permeabilidad al anhídrido carbónico (EN 1062): Sd 200,29 m; Clase C1. La Clase TVOC A+ la hace idónea para cumplir con los protocolos Leed Breeam. Para uso profesional.</p> | |
| <p>Attrezzatura: pennello, rullo, airless Diluizione: acqua - 20-30% Resa (2 mani): 5 m²/l - Per confezione (14 l): 70 m² Colore: bianco e colorato</p> | | <p>Equipment: brush, roller, airless Dilution: water - 20-30% Coverage (2 coats): 5 m²/l - Per packaging (14 l): 70 m² Color: white and colored</p> | | <p>Herramientas: brocha, rodillo, pistola pulverizadora Dilución: agua - 20-30% Rendimiento (2 capas): 5 m²/l - Por envase (14 l): 70 m² Color: blanco y colorido</p> | |

| tecniche | certificazioni | proprietà | tecnologie |
|------------------|----------------|-----------|------------|
| | | | |

ivasil pittura

scheda
tecnicadata
sheetficha
técnica

| idropittura minerale ai silicati | interno esterno | water-based mineral paint with silicates | indoor outdoor | pintura mineral al agua mineral con silicatos | interior exterior |
|---|-----------------|--|----------------|--|-------------------|
| <p>Idropittura minerale ai silicati che assicura traspirabilità al vapore, idrorepellenza, resistenza agli agenti atmosferici e ai raggi UV. La componente minerale al silicato di potassio svolge una naturale protezione contro muffe e alghe. Resistente agli alcali. Particolarmente idonea per la pitturazione di edifici di interesse storico. Per uso professionale.</p> | | <p>Water-based mineral paint with silicates that is vapour permeable, water repellent, resistant to the weather and UV light. The mineral component based on potassium silicate provides natural protection against mould, mildew and algae. Resistant to alkalis. Ideal for painting buildings in historic centres. For professional use.</p> | | <p>Pintura mineral al agua con silicatos que asegura transpirabilidad al vapor, hidro-repelente, resistente a los agentes atmosféricos y a los rayos UV. El componente mineral con silicato de potasio ejerce una protección natural contra mohos y algas. Resistente a los álcalis. Particularmente idónea para el pintado de edificios en cascos antiguos. Para uso profesional.</p> | |
| <p>Attrezzatura: pennello, rullo a pelo corto, spruzzo Diluizione: Ivasil Primer S - 15-20% Resa (2 mani): 4,5-5,5 m²/l - Per confezione (14 l): 77 m² Colore: bianco e colorato</p> | | <p>Equipment: brush, roller, airless Dilution: Ivasil Primer S - 15-20% Coverage (2 coats): 4,5-5,5 m²/l - Per packaging (14 l): 77 m² Color: white and colored</p> | | <p>Herramientas: brocha, rodillo a pelo corto, pistola pulverizadora Dilución: Ivasil Primer S - 15-20% Rendimiento (2 capas): 4,5-5,5 m²/l - Por envase (14 l): 77 m² Color: blanco y colorido</p> | |

| tecniche | certificazioni | proprietà | tecnologie |
|------------------|----------------|-----------|------------|
| | | | |

deco sand plus



scheda
tecnica



data
sheet



ficha
técnica



| | | | | | |
|--|-------------------------------|--|------------------------------|--|---------------------------------|
| <p>idropittura mascherante ad effetto decorativo sabbato</p> | <p>interno esterno</p> | <p>water-based masking paint with decorative sandblasted</p> | <p>indoor outdoor</p> | <p>pintura al agua enmascarante de efecto decorativo arenado</p> | <p>interior exterior</p> |
| <p>Idropittura acrilossilossanica con farina di quarzo ad alto potere mascherante e riempitivo. La curva granulometrica rende la finitura idonea per uniformare e mascherare facciate rappezzate ottenendo un'elevata copertura e resistenza agli agenti atmosferici. L'applicazione della seconda mano con idonea pennellatura permette di ottenere una finitura ad effetto sabbato ad alto valore estetico. Film protetto dall'attacco di alghe, muffe e microrganismi. Per uso professionale.</p> | | <p>Water-based acrylic-siloxane paint containing quartz flour with high masking and filling properties. The range in size of the particles makes it possible to smooth out and mask patched façades, obtaining high coverage and resistance to the weather. By applying the second coat with a suitable flat brush, a highly attractive, sandblasted effect can be achieved. Film protected against algae, mould and microorganisms. For professional use.</p> | | <p>Pintura al agua acrilossiloxánica con harina de cuarzo de gran poder enmascarante y de relleno. La curva granulométrica hace de ella el acabado idóneo para uniformar y enmascarar fachadas con reparaciones para obtener una gran capacidad cubriente y resistencia a los agentes atmosféricos. La aplicación de la segunda mano con una brocha ancha permite obtener un acabado de efecto arena de alto valor estético. Película protectora contra el ataque de algas, mohos y microorganismos. Para uso profesional.</p> | |
| <p>Attrezzatura: pennello, rullo Diluizione: acqua - 0-15% Resa (1 mano): 3,5-5,5 m²/l - Per confezione (14 l): 49-77 m² Colore: bianco e colorato</p> | | <p>Equipment: brush, roller Dilution: water - 0-15% Coverage (1 coat): 3,5-5,5 m²/l - Per packaging (14 l): 49-77 m² Color: white and colored</p> | | <p>Herramientas: brocha, rodillo Dilución: agua - 0-15% Rendimiento (1 capa): 3,5-5,5 m²/l - Por envase (14 l): 49-77 m² Color: blanco y colorido</p> | |

| tecniche | | | | certificazioni | | | | proprietà | | | | tecnologie | | | | |
|----------|--|--|--|----------------|--|--|--|-----------|--|--|--|------------|--|--|--|--|
| | | | | | | | | | | | | | | | | |

ivaglass lucido

scheda
tecnicadata
sheetficha
técnica

| smalto bicomponente acrilpoliuretano | interno esterno | two-pack acryl-polyurethane enamel | indoor outdoor | esmalte bicomponente acrilpoliuretánico | interior exterior |
|--|-----------------|--|----------------|--|-------------------|
| Smalto bicomponente acrilpoliuretano lucido non ingiallente, a base di pigmenti di alto pregio dispersi in veicolo acrilico, induritore isocianato alifatico. Dotato di elevata resistenza agli agenti chimici, alle soluzioni saline e all'esposizione in atmosfera industriale aggressiva e marina e particolarmente idoneo su supporti a bassa adesione. La particolare formulazione permette di realizzare tinte RAL anche per applicazione su grandi superfici di capannoni industriali. Per uso professionale. | | Gloss two-pack, non-yellowing, acryl-polyurethane enamel based on high quality pigments dispersed in an acrylic medium and aliphatic isocyanate hardener. Highly resistant to chemicals, saline solutions and to exposure in aggressive industrial and marine atmospheres. Particularly suitable for substrates offering poor adhesion. Its unique formulation makes it possible to create RAL colours, even for application on the large surfaces of industrial warehouses. For professional use. | | Esmalte bicomponente acrilpoliuretánico brillante no amarilla, a base de pigmentos de alta calidad dispersos en vehículo acrílico, endurecedor isocianato alifático. Dotado de alta resistencia a los agentes químicos, a las soluciones salinas y a la exposición a atmósfera industrial agresiva y marina; particularmente idóneo sobre soportes poco adhesivos. Su particular formulación permite realizar tintes RAL también para su aplicación sobre grandes superficies de naves industriales. Para uso profesional. | |
| Attrezzatura: pennello, rullo, airless Rapporto di catalisi: (A:B) 3:1 in volume Diluizione: Diluente per Poliuretano - max 10% (ailess max 15%) Resa (2 mani): 4-4,5 m ² /l - Per confezione (12 l + 4 l): 72 m ² Colore: bianco e colorato | | Equipment: brush, roller, airless Ratio of catalysis: (A:B) 3:1 in volume Dilution: Diluente per Poliuretano - max 10% (ailess max 15%) Coverage (2 coats): 4-4,5 m ² /l - Per packaging (12 l + 4 l): 72 m ² Color: white and colored | | Herramientas: brocha, rodillo, pistola pulverizadora Relación de mezcla: (A:B) 3:1 por volumen Dilución: Diluente per Poliuretano - 10% (pistola pulverizadora max 15%) Rendimiento (2 capas): 4-4,5 m ² /l - Por envase (12 l + 4 l): 72 m ² Color: blanco y colorido | |

| tecniche | certificazioni | proprietà | tecnologie |
|----------|----------------|-----------|------------|
| | | | |

ivaglass opaco

scheda
tecnicadata
sheetficha
técnica

| smalto bicomponente acrilpoliuretano | interno esterno | two-pack acryl-polyurethane enamel | indoor outdoor | esmalte bicomponente acrilpoliuretánico | interior exterior |
|--|-----------------|---|----------------|--|-------------------|
| Smalto bicomponente acrilpoliuretano opaco, non ingiallente, a base di pigmenti di alto pregio dispersi in veicolo acrilico, induritore isocianato alifatico. Dotato di elevata resistenza agli agenti chimici, alle soluzioni saline e all'esposizione in atmosfera industriale aggressiva e marina e particolarmente idoneo su supporti a bassa adesione. La particolare formulazione permette di realizzare tinte RAL anche per applicazione su grandi superfici di capannoni industriali. Per uso professionale. | | Matt two-pack, non-yellowing, acryl-polyurethane enamel based on high quality pigments dispersed in an acrylic medium and aliphatic isocyanate hardener. Highly resistant to chemicals, saline solutions and to exposure in aggressive industrial and marine atmospheres. Particularly suitable for substrates offering poor adhesion. Its unique formulation makes it possible to create RAL colours, even for application on the large surfaces of industrial warehouses. For professional use. | | Esmalte bicomponente acrilpoliuretánico mate, no amarilla, a base de pigmentos de alta calidad dispersos en vehículo acrílico, endurecedor isocianato alifático. Dotado de alta resistencia a los agentes químicos, a las soluciones salinas y a la exposición a atmósfera industrial agresiva y marina; particularmente idóneo sobre soportes poco adhesivos. Su particular formulación permite realizar tintes RAL también para su aplicación sobre grandes superficies de naves industriales. Para uso profesional. | |
| Attrezzatura: pennello, rullo, airless Rapporto di catalisi: (A:B) 3:1 in volume Diluizione: Diluente per Poliuretano - max 10% (ailess max 15%) Resa (2 mani): 4-4,5 m ² /l - Per confezione (12 l + 4 l): 72 m ² Colore: bianco e colorato | | Equipment: brush, roller, airless Ratio of catalysis: (A:B) 3:1 in volume Dilution: Diluente per Poliuretano - max 10% (ailess max 15%) Coverage (2 coats): 4-4,5 m ² /l - Per packaging (12 l + 4 l): 72 m ² Color: white and colored | | Herramientas: brocha, rodillo, pistola pulverizadora Relación de mezcla: (A:B) 3:1 por volumen Dilución: Diluente per Poliuretano - 10% (pistola pulverizadora max 15%) Rendimiento (2 capas): 4-4,5 m ² /l - Por envase (12 l + 4 l): 72 m ² Color: blanco y colorido | |

| tecniche | certificazioni | proprietà | tecnologie |
|----------|----------------|-----------|------------|
| | | | |

betonglass lucido



scheda
tecnica



data
sheet



ficha
técnica



| | | |
|--|--|--|
| <p>smalto lucido bicomponente acrilpoliuretano per CLS</p> <p>interno esterno</p> | <p>two-pack acryl-polyurethane enamel for concrete</p> <p>indoor outdoor</p> | <p>esmalte bicomponente acrilpoliuretánico para hormigón</p> <p>interior exterior</p> |
| <p>Smalto bicomponente acril-poliuretano lucido non ingiallente, specificatamente formulato per la protezione del calcestruzzo. Dotato di elevata resistenza agli agenti chimici, alle soluzioni saline ed all'esposizione in atmosfera industriale aggressiva e marina.</p> | <p>Gloss two-pack, non-yellowing, acryl-polyurethane enamel formulated specifically to protect concrete. Highly resistant to chemicals, saline solutions and to exposure in aggressive industrial and marine atmospheres. For professional use.</p> | <p>Esmalte bicomponente acrilpoliuretánico brillante, no amarillea, formulado específicamente para la protección del hormigón. Dotado de alta resistencia a los agentes químicos, a las soluciones salinas y a la exposición a atmósfera industrial agresiva y marina. Para uso profesional.</p> |
| <p>Attrezzatura: pennello, rullo, airless Rapporto di catalisi: (A:B) 3:1 in volume Diluizione: Diluente per Poliuretani - max 10% (airless max 15%) Resa (2 mani): 4-4,5 m²/l - Per confezione (12 l + 4 l): 72 m² Colore: bianco e colorato</p> | <p>Equipment: brush, roller, airless Ratio of catalysis: (A:B) 3:1 in volume Dilution: Diluente per Poliuretani - max 10% (airless max 15%) Coverage (2 coats): 4-4,5 m²/l - Per packaging (12 l + 4 l): 72 m² Color: white and colored</p> | <p>Herramientas: brocha, rodillo, pistola pulverizadora Relación de mezcla: (A:B) 3:1 por volumen Dilución: Diluyente per Poliuretani - max 10% (pistola pulverizadora max 15%) Rendimiento (2 capas): 4-4,5 m²/l - Por envase (12 l + 4 l): 72 m² Color: blanco y colorido</p> |

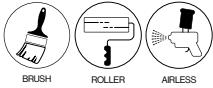

| tecniche | certificazioni | proprietà | tecnologie |
|---|----------------|---------------------------------|--------------|
| SOLVENT BASED BRUSH ROLLER AIRLESS | | gloss BRILLIANCE WALKABLE | resistance 5 |

betonglass opaco



scheda
tecnica



data
sheet



ficha
técnica



| | | |
|--|--|--|
| <p>smalto opaco bicomponente acrilpoliuretano per CLS</p> <p>interno esterno</p> | <p>two-pack acryl-polyurethane enamel for concrete</p> <p>indoor outdoor</p> | <p>esmalte bicomponente acrilpoliuretánico para hormigón</p> <p>interior exterior</p> |
| <p>Smalto bicomponente acril-poliuretano opaco, non ingiallente, specificatamente formulato per la protezione del calcestruzzo. Dotato di elevata resistenza agli agenti chimici, alle soluzioni saline ed all'esposizione in atmosfera industriale aggressiva e marina. Per uso professionale.</p> | <p>Matt two-pack, non-yellowing, acryl-polyurethane enamel formulated specifically to protect concrete. Highly resistant to chemicals, saline solutions and to exposure in aggressive industrial and marine atmospheres. For professional use.</p> | <p>Esmalte bicomponente acrilpoliuretánico mate, no amarillea, formulado específicamente para la protección del hormigón. Dotado de alta resistencia a los agentes químicos, a las soluciones salinas y a la exposición a atmósfera industrial agresiva y marina. Para uso profesional.</p> |
| <p>Attrezzatura: pennello, rullo, airless Rapporto di catalisi: (A:B) 3:1 in volume Diluizione: Diluente per Poliuretani - max 10% (airless max 15%) Resa (2 mani): 4-4,5 m²/l - Per confezione (12 l + 4 l): 72 m² Colore: bianco e colorato</p> | <p>Equipment: brush, roller, airless Ratio of catalysis: (A:B) 3:1 in volume Dilution: Diluente per Poliuretani - max 10% (airless max 15%) Coverage (2 coats): 4-4,5 m²/l - Per packaging (12 l + 4 l): 72 m² Color: white and colored</p> | <p>Herramientas: brocha, rodillo, pistola pulverizadora Relación de mezcla: (A:B) 3:1 por volumen Dilución: Diluyente per Poliuretani - max 10% (pistola pulverizadora max 15%) Rendimiento (2 capas): 4-4,5 m²/l - Por envase (12 l + 4 l): 72 m² Color: blanco y colorido</p> |

| tecniche | certificazioni | proprietà | tecnologie |
|---|----------------|--------------------------------|--------------|
| SOLVENT BASED BRUSH ROLLER AIRLESS | | matt BRILLIANCE WALKABLE | resistance 5 |



exterio

rivestimenti e finiture high tech

prodotti

intogum plus g12

intogum plus g10

intonachino idrosiliconico plus g08

intonachino idrosiliconico plus g06

rivasil g15

rivasil g12

ivasil intonachino g08



orht

intogum plus g12

scheda
tecnicadata
sheetficha
técnica

| rivestimento a spessore elastomerico - 1.2 mm | esterno | thick elastomeric coating - 1.2 mm | outdoor | revestimiento de espesor elastomérico - 1.2 mm | exterior |
|--|---------|--|---------|--|----------|
| Rivestimento all'acqua a spessore caratterizzato da un alto potere riempitivo. Possiede elevate resistenze meccaniche unite ad un alto valore dell'allungamento percentuale riducendo i rischi di cavillature e screpolature del prodotto sollecitato a forti tensioni superficiali. Si presta come barriera alla penetrazione della CO ₂ sui cementi armati a vista. Forma un film resistente all'attacco di alghe, funghi e muffe. Per uso professionale. | | Thick water-based coating with high filling power. Offers high mechanical resistance together with a high percentage elongation value, thus reducing the risk of cracks and fissures in the product when subject to strong surface tensions. Serves as a barrier to CO ₂ penetration into exposed reinforced concrete. Produces a mould, algae, and fungi-resistant film. For professional use. | | Revestimiento de espesor al agua caracterizado por un alto poder de relleno. Posee una gran resistencia mecánica que, junto con un alto valor de alargamiento porcentual, reduce los riesgos de cuarteados y agrietamientos del producto sometido a fuertes tensiones superficiales. Se presta como barrera a la penetración del CO ₂ en hormigones armados a la vista. Forma una película resistente al ataque de algas, hongos y mohos. Para uso profesional. | |
| Granulometria: 1,2 mm Attrezzatura: spatola di acciaio Diluizione: pronto all'uso Resa (1 mano): 1,9 kg/ m ² - Per confezione (25 kg): 13 m ² Colore: bianco e colorato | | Particle size: 1,2 mm Equipment: steel spatula Dilution: ready to use Coverage (1 coat): 1,9 kg/ m ² - Per packaging (25 kg): 13 m ² Color: white and colored | | Granulometría: 1,2 mm Herramientas: espátula de acero Dilución: listo para usar Rendimiento (1 capa): 1,9 kg/ m ² - Por envase (25 kg): 13 m ² Color: blanco y colorido | |

| tecniche | certificazioni | proprietà | tecnologie |
|---------------------------------------|----------------|------------|---------------------------------|
| WATER BASED TROWEL READY TO USE | CE EN 15824 | BREATHABLE | plus flex 5 cig protect 4 |

intogum plus g10

scheda
tecnicadata
sheetficha
técnica

| rivestimento a spessore elastomerico - 1 mm | esterno | thick elastomeric coating - 1 mm | outdoor | revestimiento de espesor elastomérico 1 mm | exterior |
|---|---------|--|---------|---|----------|
| Rivestimento all'acqua a spessore caratterizzato da un alto potere riempitivo. Applicato a due mani possiede elevate resistenze meccaniche unite ad un alto valore dell'allungamento percentuale riducendo i rischi di cavillature e screpolature del prodotto sollecitato a forti tensioni superficiali. Si presta come barriera alla penetrazione della CO ₂ sui cementi armati a vista. Forma un film resistente all'attacco di alghe, funghi e muffe. Per uso professionale. | | Thick water-based coating with high filling power. When applied in two coats, it offers high mechanical resistance together with a high percentage elongation value, thus reducing the risk of cracks and fissures in the product when subject to strong surface tensions. Serves as a barrier to CO ₂ penetration into exposed reinforced concrete. Produces a mould-, algae-, and fungi-resistant film. For professional use. | | Revestimiento de espesor al agua caracterizado por un alto poder de relleno. Aplicado en dos manos, posee una gran resistencia mecánica que, junto con un alto valor de alargamiento porcentual, reduce los riesgos de cuarteados y agrietamientos del producto sometido a fuertes tensiones superficiales. Se presta como barrera a la penetración del CO ₂ en hormigones armados a la vista. Forma una película resistente al ataque de algas, hongos y mohos. Para uso profesional. | |
| Granulometria: 0,9 - 1mm Attrezzatura: spatola di acciaio Diluizione: pronto all'uso Resa (1 mano): 1,5-1,6 kg/m ² - Per confezione (25 kg): 16,5 m ² Colore: bianco e colorato | | Particle size: 0,9 - 1mm Equipment: steel spatula Dilution: ready to use Coverage (1 coat): 1,5-1,6 kg/m ² - Per packaging (25 kg): 16,5 m ² Color: white and colored | | Granulometría: 0,9 - 1mm Herramientas: espátula de acero Dilución: listo para usar Rendimiento (1 capa): 1,5-1,6 kg/m ² - Por envase (25 kg): 16,5 m ² Color: blanco y colorido | |

| tecniche | certificazioni | proprietà | tecnologie |
|---------------------------------------|----------------|------------|---------------------------------|
| WATER BASED TROWEL READY TO USE | CE EN 15824 | BREATHABLE | plus flex 5 cig protect 4 |

intonachino idrosiliconico plus g08



scheda
tecnica



data
sheet



ficha
técnica



| | | |
|--|---|--|
| <p>polisilossano ad effetto intonachino - 0.8 mm</p> <p>esterno</p> | <p>coating with a polysiloxane intonachino effect - 0.8 mm</p> <p>outdoor</p> | <p>efecto intonachino polisiloxano - 0.8 mm</p> <p>exterior</p> |
| <p>Rivestimento all'acqua a spessore a base di resine polisilossaniche. Caratterizzato da elevata traspirabilità, resistenza alle intemperie, ritenzione di sporco e basso assorbimento d'acqua. Si presta per rinnovare supporti con vecchie pitture o irregolari conferendo protezione e durabilità. Film protetto dall'attacco di alghe, funghi e muffe. Per uso professionale.</p> | <p>Thick water-based coating containing polysiloxane resins. Features high breathability and resistance to bad weather, dirt retention and low water absorption. Lends itself to renovating substrates with old or uneven paint, protecting them and ensuring durability. Film protected against mould, algae, and fungi. For professional use.</p> | <p>Revestimiento de espesor al agua a base de resinas polisiloxánicas. Caracterizado por su gran transpirabilidad, resistencia a la intemperie, retención de la suciedad y baja absorción de agua. Idóneo para renovar soportes con pintura vieja o irregular, proporcionando protección y durabilidad. Película protectora contra el ataque de algas, hongos y mohos. Para uso profesional.</p> |
| <p>Granulometria: 0,8 - 1 mm Attrezzatura: spatola metallica, plastica, finitura con frattazzo di spugna Diluizione: pronto all'uso Resa (2 mani): 1,3-1,6 kg/m² - Per confezione (25 kg): 19 m² Colore: bianco e colorato</p> | <p>Particle size: 0,8 - 1 mm Equipment: metal spatula, plastic, finish with sponge trowel Dilution: ready to use Coverage (2 coats): 1,3-1,6 kg/m² - Per packaging (25 kg): 19 m² Color: white and colored</p> | <p>Granulometría: 0,8 - 1 mm Herramientas: llana metálica, llana de plástico, llana de esponja Dilución: listo para usar Rendimiento (2 capas): 1,3-1,6 kg/m² - Por envase (25 kg): 19 m² Color: blanco y colorido</p> |

| | | | |
|------------------------|------------------------------|-------------------------|--------------------------|
| <p>tecniche</p> | <p>certificazioni</p> | <p>proprietà</p> | <p>tecnologie</p> |
|------------------------|------------------------------|-------------------------|--------------------------|

intonachino idrosiliconico plus g06



scheda
tecnica



data
sheet



ficha
técnica







| | | |
|--|---|--|
| <p>polisilossano ad effetto intonachino - 0.6 mm</p> <p>esterno</p> | <p>coating with a polysiloxane intonachino effect - 0.6 mm</p> <p>outdoor</p> | <p>efecto intonachino polisiloxano - 0.6 mm</p> <p>exterior</p> |
| <p>Rivestimento all'acqua a spessore a base di resine polisilossaniche. Caratterizzato da elevata traspirabilità, resistenza alle intemperie, ritenzione di sporco e basso assorbimento d'acqua. Si presta per rinnovare supporti con vecchie pitture o irregolari conferendo protezione e durabilità. Film protetto dall'attacco di alghe, funghi e muffe. Per uso professionale.</p> | <p>Thick water-based coating containing polysiloxane resins. Features high breathability and resistance to bad weather, dirt retention and low water absorption. Lends itself to renovating substrates with old or uneven paint, protecting them and ensuring durability. Film protected against mould, algae, and fungi. For professional use.</p> | <p>Revestimiento de espesor al agua a base de resinas polisiloxánicas. Caracterizado por su gran transpirabilidad, resistencia a la intemperie, retención de la suciedad y baja absorción de agua. Idóneo para renovar soportes con pintura vieja o irregular, proporcionando protección y durabilidad. Película protectora contra el ataque de algas, hongos y mohos. Para uso profesional.</p> |
| <p>Granulometria: 0,6 mm Attrezzatura: spatola metallica, plastica, finitura con frattazzo di spugna Diluizione: pronto all'uso Resa (2 mani): 1,3-1,6 kg/m² - Per confezione (25 kg): 20 m² Colore: bianco e colorato</p> | <p>Particle size: 0,6 mm Equipment: metal spatula, plastic, finish with sponge trowel Dilution: ready to use Coverage (2 coats): 1,3-1,6 kg/m² - Per packaging (25 kg): 20 m² Color: white and colored</p> | <p>Granulometría: 0,6 mm Herramientas: llana metálica, llana de plástico, llana de esponja Dilución: listo para usar Rendimiento (2 capas): 1,3-1,6 kg/m² - Por envase (25 kg): 20 m² Color: blanco y colorido</p> |

| | | | |
|------------------------|------------------------------|-------------------------|--------------------------|
| <p>tecniche</p> | <p>certificazioni</p> | <p>proprietà</p> | <p>tecnologie</p> |
|------------------------|------------------------------|-------------------------|--------------------------|

rivasil g15

scheda
tecnicadata
sheetficha
técnica









| rivestimento minerale ai silicati - 1.5 mm | esterno | mineral coating with silicates - 1.5 mm | outdoor | revestimiento mineral con silicatos - 1.5 mm | exterior |
|---|---------|---|---------|--|----------|
| <p>Rivestimento minerale a spessore continuo, formulato con silicato alcalino a norma DIN 18363. Formulato in modo da assicurare traspirabilità al vapore, resistenza alle intemperie, alla luce e agli agenti inquinanti in genere. Differisce dai normali rivestimenti plastici continui in quanto la superficie che si ottiene ha un aspetto pieno ed uniforme. Per uso professionale.</p> | | <p>Continuous thick mineral coating formulated with alkaline silicate in accordance with DIN 18363. Formulated to guarantee vapour permeability, resistant to bad weather, light and pollutants in general. It differs from normal continuous plastic coatings because it achieves a full, uniform surface. For professional use.</p> | | <p>Revestimiento mineral de espesor continuo, formulado con silicato alcalino conforme a la norma DIN 18363. Formulado para asegurar la transpirabilidad al vapor, resistencia a la intemperie, a la luz y a los agentes contaminantes en general. Se diferencia de los revestimientos plásticos de espesor continuo más comunes en que la superficie que se obtiene presenta un aspecto pleno y uniforme. Para uso profesional.</p> | |
| <p>Granulometria: max 1,5 mm Attrezzatura: frattazzo metallico o plastico Diluizione: pronto all'uso Resa (1 mano): 3 kg/m² - Per confezione (25 kg): 8,3 m² Colore: bianco e colorato</p> | | <p>Particle size: max 1,5 mm Equipment: metal or plastic trowel Dilution: ready to use Coverage (1 coat): 3 kg/m² - Per packaging (25 kg): 8,3 m² Color: white and colored</p> | | <p>Granulometría: max 1,5 mm Herramientas: llana metálica, llana de plástico Dilución: listo para usar Rendimiento (1 capa): 3 kg/m² - Por envase (25 kg): 8,3 m² Color: blanco y colorido</p> | |

| tecniche | certificazioni | proprietà | tecnologie |
|--|---|---|---|
|  COLOURABLE  WATER BASED  TROWEL  READY TO USE |  |  MINERAL  BREATHABLE |  |

rivasil g12

scheda
tecnicadata
sheetficha
técnica

| rivestimento minerale ai silicati - 1.2 mm | esterno | mineral coating with silicates - 1.2 mm | outdoor | revestimiento mineral con silicatos - 1.2 mm | exterior |
|---|---------|---|---------|--|----------|
| <p>Rivestimento minerale a spessore continuo, formulato con silicato alcalino a norma DIN 18363. Formulato in modo da assicurare traspirabilità al vapore, resistenza alle intemperie, alla luce e agli agenti inquinanti in genere. Differisce dai normali rivestimenti plastici continui in quanto la superficie che si ottiene ha un aspetto pieno ed uniforme. Per uso professionale.</p> | | <p>Continuous thick mineral coating formulated with alkaline silicate in accordance with DIN 18363. Formulated to guarantee vapour permeability, resistant to bad weather, light and pollutants in general. It differs from normal continuous plastic coatings because it achieves a full, uniform surface. For professional use.</p> | | <p>Revestimiento mineral de espesor continuo, formulado con silicato alcalino conforme a la norma DIN 18363. Formulado para asegurar la transpirabilidad al vapor, resistencia a la intemperie, a la luz y a los agentes contaminantes en general. Se diferencia de los revestimientos plásticos de espesor continuo más comunes en que la superficie que se obtiene presenta un aspecto pleno y uniforme. Para uso profesional.</p> | |
| <p>Granulometria: max 1,2 mm Attrezzatura: frattazzo metallico o plastico Diluizione: pronto all'uso Resa (1 mano): 2,2 kg/m² - Per confezione (25 kg): 11,4 m² Colore: bianco e colorato</p> | | <p>Particle size: max 1,2 mm Equipment: metal or plastic trowel Dilution: ready to use Coverage (1 coat): 2,2 kg/m² - Per packaging (25 kg): 11,4 m² Color: white and colored</p> | | <p>Granulometría: max 1,2 mm Herramientas: llana metálica, llana de plástico Dilución: listo para usar Rendimiento (1 capa): 2,2 kg/m² - Por envase (25 kg): 11,4 m² Color: blanco y colorido</p> | |

| tecniche | certificazioni | proprietà | tecnologie |
|--|---|---|---|
|  COLOURABLE  WATER BASED  TROWEL  READY TO USE |  |  MINERAL  BREATHABLE |  |

ivasil intonachino g08



scheda
tecnica



data
sheet



ficha
técnica



| rivestimento ai silicati ad effetto intonachino - 0.8 mm | esterno | rivestimento ai silicati ad effetto intonachino - 0.8 mm | outdoor | revestimiento de efecto intonachino con silicatos - 0.8 mm | exterior |
|--|---------|--|---------|--|----------|
| Rivestimento minerale a base di silicato di potassio alcalino in soluzione acquosa, pigmenti naturali e graniglie di marmo che ne conferiscono spessore e lo rendono atto a livellare supporti irregolari. Formulato specificatamente per edifici di interesse storico e come finitura cicli deumidificanti. Per uso professionale | | Mineral coating based on alkaline potassium silicate in a water-based solution, natural pigments and marble granules that provide thickness and make it ideal for levelling irregular substrates. Specifically formulated for historic buildings and as a topcoat for dehumidifying processes. For professional use. | | Revestimiento mineral a base de silicato de potasio alcalino en solución acuosa, pigmentos naturales y granallas de mármol que le dan espesor y lo hacen idóneo para nivelar soportes irregulares. Formulado específicamente para edificios de interés histórico y como acabado para ciclos deshumidificantes. Para uso profesional. | |
| Granulometria: 0,8 - 1 mm Attrezzatura: frattazzo metallico, plastico o di spugna Diluizione: pronto all'uso Resa (1 mano): 1,25 kg/m ² - Per confezione (25 kg): 19,2 m ² Colore: bianco e colorato | | Particle size: 0,8 - 1 mm Equipment: metal, plastic or sponge trowel Dilution: ready to use Coverage (1 coat): 1,25 kg/m ² - Per packaging (25 kg): 19,2 m ² Color: white and colored | | Granulometría: 0,8 - 1 mm Herramientas: llana metálica, llana de plástico, llana de esponja Dilución: listo para usar Rendimiento (1 capa): 1,25 kg/m ² - Por envase (25 kg): 19,2 m ² Color: blanco y colorido | |

| tecniche | | | certificazioni | | | proprietà | | | tecnologie | | |
|----------|--|--|----------------|--|--|-----------|--|--|------------|--|--|
| | | | | | | | | | | | |



exterior

rivestimenti e finiture

prodotti

finquarz
quarzoplast
graffiato
rugoplast

Dr

finquarz



scheda
tecnica



data
sheet



ficha
técnica



| idropittura al quarzo | esterno | water-based quartz paint | outdoor | pintura al agua con cuarzo | exterior |
|--|---------|---|---------|--|----------|
| <p>Microrivestimento con farina di quarzo, a base di resine viniliche. Finitura riempitiva di aspetto opaco, insensibile all'alcalinità del supporto; resistente alla proliferazione di muffe; resistente agli agenti atmosferici pur permettendo traspirabilità. Per uso professionale.</p> | | <p>Quartz flour-based micro-coating with vinyl resins. Filler topcoat, insensitive to the alkalinity of the substrate; resistant to the proliferation of mould and mildew; resistant to the weather while still ensuring breathability. Matt finish For professional use.</p> | | <p>Micro-revestimiento con harina de cuarzo, a base de resinas vinílicas. Acabado de relleno de aspecto mate, insensible a la alcalinidad del soporte; resistente a la proliferación de mohos; resistente a los agentes atmosféricos y transpirante al mismo tiempo. Para uso profesional.</p> | |
| <p>Attrezzatura: pennello, rullo, airless Diluizione: acqua - prima mano: 20-30%, seconda mano: 15-20% Resa (2 mani): 3-4 m²/l - Per confezione (14 l): 56 m² Colore: bianco e colorato</p> | | <p>Equipment: brush, roller, airless Dilution: water - 1°coat: 20-30%, 2°coat: 15-20% Coverage (2 coats): 3-4 m²/l - Per packaging (14 l): 56 m² Color: white and colored</p> | | <p>Herramientas: brocha, rodillo, pistola pulverizadora Dilución: agua - 1° capa: 20-30%, 2° capa: 15-20% Rendimiento (2 capas): 3-4 m²/l - Por envase (14 l): 56 m² Color: blanco y colorido</p> | |

tecniche



certificazioni

proprietà



tecnologie

quarzoplast



scheda
tecnica



data
sheet



ficha
técnica



| rivestimento plastico continuo ad effetto bucciato | esterno | continuous plastic coating with orange-peel effect | outdoor | revestimiento plástico continuo de efecto moteado | exterior |
|---|---------|---|---------|---|----------|
| <p>Rivestimento plastico ad effetto bucciato. A base di resine acriliche in dispersione, additivi vari atti a facilitare l'applicazione e la filmazione, sabbie quarzifere a diversa granulometria che ne conferiscono il caratteristico aspetto bucciato. Per uso professionale.</p> | | <p>Plastic coating with orange-peel effect. Based on acrylic resins in dispersion, contains various additives to facilitate application and film-formation as well as quartz sand of various particle size to create the characteristic orange-peel effect. For professional use.</p> | | <p>Revestimiento plástico de efecto moteado. A base de resinas acrílicas en dispersión, aditivos varios con la función de facilitar la aplicación y la formación de película, arenas de cuarzo de distintas granulometrías que le proporcionan su característico aspecto moteado. Para uso profesional.</p> | |
| <p>Attrezzatura: pennello, rullo e frattazzo metallico o plastico Diluizione: pronto all'uso Resa (1 mano): 1,25 m²/l - Per confezione (14 l): 17,5 m² Colore: bianco e colorato</p> | | <p>Equipment: brush, roller e metal or plastic trowel Dilution: ready to use Coverage (1 coat): 1,25 m²/l - Per packaging (14 l): 17,5 m² Color: white and colored</p> | | <p>Herramientas: brocha, rodillo, llana metálica, llana de plástico Dilución: listo para usar Rendimiento (1 capa): 1,25 m²/l - Por envase (14 l): 17,5 m² Color: blanco y colorido</p> | |

tecniche



certificazioni



proprietà



tecnologie



graffiato



scheda
tecnica



data
sheet



ficha
técnica



| | | |
|--|--|--|
| rivestimento plastico continuo ad effetto graffiato esterno | continuous plastic coating with scratched effect outdoor | revestimiento plástico continuo de efecto rayado exterior |
| Rivestimento plastico continuo che riproduce il caratteristico effetto graffiato. A base di emulsione di resine sintetiche, sabbie quarzifere a diversa granulometria ed additivi atti a facilitare l'applicazione e la filmazione, pigmenti colorati resistenti alla luce ed alle condizioni atmosferiche più gravose. Per uso professionale. | Continuous plastic coating that reproduces a conventional scratched effect. Based on an emulsion of synthetic resins, quartz sands of different particle sizes and additives to facilitate application and film forming, coloured pigments resistant to light and to the most severe atmospheric conditions. For professional use. | Revestimiento plástico continuo que reproduce el característico efecto rayado. A base de emulsión de resinas sintéticas, arenas de cuarzo de distintas granulometrías y aditivos con la función de facilitar la aplicación y la formación de película, pigmentos de color resistentes a la luz y a las condiciones atmosféricas más exigentes. Para uso profesional. |
| Granulometria: max 1,7 mm Attrezzatura: frattazzo metallico o plastico Diluizione: pronto all'uso Resa (1 mano): 3 kg/m ² - Per confezione (25 kg): 8,3 m ² Colore: bianco e colorato | Particle size: max 1,7 mm Equipment: metal or plastic trowel Dilution: ready to use Coverage (1 coat): 3 kg/m ² - Per packaging (25 kg): 8,3 m ² Color: white and colored | Granulometría: max 1,7 mm Herramientas: llana metálica, llana de plástico Dilución: listo para usar Rendimiento (1 capa): 3 kg/m ² - Por envase (25 kg): 8,3 m ² Color: blanco y colorido |

| tecniche | certificazioni | proprietà | tecnologie |
|----------|----------------|-----------|------------|
| | | | |

rugoplast



scheda
tecnica



data
sheet



ficha
técnica



| | | |
|---|---|---|
| rivestimento plastico continuo mascherante esterno | continuous plastic coating with masking effect outdoor | revestimiento plástico continuo de efecto máscara exterior |
| Rivestimento indicato per mascherare le disuniformità del supporto, dotato di buona elasticità, può essere applicato in forti spessori senza evidenziare screpolature. A base di resine viniliche in dispersione, graniglie di marmo e sabbie quarzifere, speciali additivi che lo rendono idrorepellente e ne conferiscono il caratteristico aspetto. Per uso professionale. | Ideal for covering unevenness in the substrates. Given its good elasticity, it can be applied in very thick coats without showing cracking. Based on vinyl resins in dispersion, marble granules and quartz sand, with special additives that make it water-repellent and impart its characteristic appearance. For professional use. | Revestimiento idóneo para enmascarar problemas de falta de uniformidad en el soporte; su buena elasticidad permite su aplicación en espesores gruesos sin mostrar cuarteados. A base de resinas vinílicas en dispersión, granallas de mármol y arenas de cuarzo, aditivos especiales que lo hacen hidro-repellente y le proporcionan su aspecto característico. Para uso profesional. |
| Granulometria: max 0,6 mm Attrezzatura: frattazzo metallico, rullo di spugna a nido d'ape Diluizione: pronto all'uso Resa (1 mano): 3-3,5 kg/m ² - Per confezione (25 kg): 8,3 m ² Colore: bianco e colorato | Particle size: max 0,6 mm Equipment: metal trowel, sponge, honeycomb roller Dilution: ready to use Coverage (1 coat): 3-3,5 kg/m ² - Per packaging (25 kg): 8,3 m ² Color: white and colored | Granulometría: max 0,6 mm Herramientas: llana metálica, rodillo de esponja alveolar Dilución: listo para usar Rendimiento (1 capa): 3-3,5 kg/m ² - Por envase (25 kg): 8,3 m ² Color: blanco y colorido |

| tecniche | certificazioni | proprietà | tecnologie |
|----------|----------------|-----------|------------|
| | | | |

| | prodotto | caratteristiche principali |
|--|--|--|
| PAINT HT | silox plus pag. 52 | idropittura polisilossanica a effetto vellutato |
| | superquarz plus pag. 53 | idropittura acrisilossanica con farina di quarzo |
| | ultra dry pag. 53 | pittura idrorepellente protettiva |
| | superclean plus pag. 53 | idropittura autopulente ad effetto fotocatalitico |
| | superquarz plus strong pag. 54 | idropittura al quarzo per colori intensi |
| | superquarz plus reflect pag. 54 | idropittura al quarzo riflettente |
| | ivasgum side finitura pag. 55 | pittura elastomerica |
| | quarzogum plus pag. 55 | pittura elastomerica riempitiva al quarzo |
| | idrobeton pag. 56 | pittura anticarbonatazione |
| | ivasil pittura pag. 56 | idropittura minerale ai silicati |
| | deco sand plus pag. 57 | idropittura mascherante ad effetto decorativo sabbiato |
| | ivaglass lucido/opaco pag. 58 | smalto bicomponente acrilpoliuretano |
| betonglass lucido/opaco pag. 59 | smalto bicomponente acrilpoliuretano per CLS | |

| | | |
|-------------|---|--|
| EXTERIOR HT | intogum g12 pag. 62 | rivestimento a spessore elastomerico - 1.2 mm |
| | intogum g10 pag. 62 | rivestimento a spessore elastomerico - 1 mm |
| | intonachino idrosiliconico g08 pag. 63 | rivestimento polisilossano ad effetto intonachino - 0.8 mm |
| | intonachino idrosiliconico g06 pag. 63 | rivestimento polisilossano ad effetto intonachino - 0.6 mm |
| | rivasil g15 pag. 64 | rivestimento minerale ai silicati 1.5 mm |
| | rivasil g12 pag. 64 | rivestimento minerale ai silicati - 1.2 mm |
| | ivasil intonachino g08 pag. 65 | rivestimento ai silicati ad effetto intonachino - 0.8 mm |

| | | |
|----------|----------------------------|---|
| EXTERIOR | finquarz pag. 68 | idropittura al quarzo |
| | quarzoplast pag. 68 | rivestimento plastico continuo ad effetto bucciato |
| | graffiato pag. 69 | rivestimento plastico continuo ad effetto graffiato |
| | rugoplast pag. 69 | rivestimento plastico continuo mascherante |

| destinazione d'uso | colori | traspirabilità | brillantezza | altro | tecnologie | certificazioni |
|--------------------|-----------|----------------|--------------|------------|---------------------------------|-------------------------|
| esterno | YouColor® | V1 | --- | --- | plus; silox 5 | A+; muffe alghe batteri |
| esterno | YouColor® | V2 | --- | --- | plus; silox 3 | A+; muffe alghe |
| esterno | YouColor® | V2 | --- | --- | dry; plus; resist 4 | --- |
| esterno | YouColor® | V2 | --- | --- | clean; plus; silox 5 | A+; muffe alghe batteri |
| esterno | YouColor® | V2 | --- | --- | strong; plus | --- |
| esterno | colorato | V2 | --- | --- | reflect; plus | --- |
| esterno | YouColor® | V2 | --- | --- | flex 5; cls protect 3; resist 3 | --- |
| esterno | YouColor® | V2 | --- | --- | plus; flex 3, cls protect 3 | --- |
| interno / esterno | YouColor® | V2 | --- | --- | cls protect 5; resist 4 | A+ |
| interno / esterno | YouColor® | V1 | --- | mineral | silicate 4 | --- |
| interno / esterno | YouColor® | V2 | --- | --- | plus; silox 3 | --- |
| interno / esterno | YouColor® | --- | --- | --- | resist 5 | --- |
| interno / esterno | colorato | --- | --- | --- | resist 5 | --- |
| | | --- | --- | --- | | |
| esterno | colorato | V1 | --- | --- | plus; fex 5; cls protect 4 | CE EN 15824 |
| esterno | colorato | V1 | --- | --- | plus; fex 5; cls protect 4 | CE EN 15824 |
| esterno | YouColor® | V1 | --- | --- | plus; siloxan 4 | CE EN 15824 |
| esterno | YouColor® | V1 | --- | --- | plus; siloxan 4 | CE EN 15824 |
| esterno | YouColor® | V1 | --- | mineral | silicate 3 | CE EN 15824 |
| esterno | YouColor® | V1 | --- | mineral | silicate 3 | CE EN 15824 |
| esterno | colorato | V1 | --- | mineral | silicate 4 | CE EN 15824 |
| | | | | | | --- |
| esterno | YouColor® | --- | matt | --- | --- | --- |
| esterno | colorato | V2 | matt | --- | flex 3 | --- |
| esterno | YouColor® | --- | --- | pronto uso | --- | --- |
| esterno | colorato | --- | --- | pronto uso | --- | --- |

anticarbonatazione - anticarbonation - anti-carbonatación

| | |
|---|-------------------------------|
| consolidamento / imprimitura consolidation/ priming consolidación / imprimación | finitura finish acabado |
| primacril pag.80 | idrobeton pag.56 |

per cavillature max 100 µ - for fine-tuning up to 100 µ - para fisuración máx. 100 µ

| | | |
|---|---|-------------------------------|
| consolidamento / imprimitura consolidation/ priming consolidación / imprimación | strato uniformante uniforming layer capa uniformadora | finitura finish acabado |
| nitrofix pag. 80 oppure primacril pag. 80 | rasofondo flex pag. 77 | quarzogum plus pag. 55 |

per cavillature max 1 mm - for fine-tuning up to 1 mm - para fisuración máx. 1 mm

| | | |
|---|---|--|
| consolidamento / imprimitura consolidation/ priming consolidación / imprimación | strato uniformante uniforming layer capa uniformadora | finitura finish acabado |
| nitrofix pag. 80 oppure primacril pag. 80 | ivasgum fondo pag. 77 | ivasgum side finitura pag. 55 oppure intogum plus pag. 62 |

per cavillature max 2 mm - for fine-tuning up to 2 mm - para fisuración máx. 2 mm

| | | | | |
|---------------------------------------|---|---|----------------------------------|---|
| risanamento restoration acabado | consolidamento / imprimitura consolidation/ priming consolidación / imprimación | strato uniformante uniforming layer capa uniformadora | rete mesh malla | finitura finish acabado |
| elastucco pag. 84 | nitrofix pag. 80 oppure primacril pag. 80 | ivasgum fondo pag. 77 | armatex micro pag. 112 | ivasgum side finitura pag. 55 oppure intogum plus pag. 62 |

antialga, antimuffa - anti alga, anti mold - antimoho, antialgas

| | | |
|---------------------------------------|---|--|
| risanamento restoration acabado | consolidamento / imprimitura consolidation/ priming consolidación / imprimación | finitura finish acabado |
| sana solux pag.41 | nitrofix pag. 80 oppure primacril pag.80 | superquarz plus pag. 52 oppure silox plus pag.52 oppure ultra dry pag. 53 |

minerali ai silicati - silicate minerals - minerales de silicato

| | | |
|---|---|--|
| consolidamento / imprimitura consolidation/ priming consolidación / imprimación | strato uniformante uniforming layer capa uniformadora | finitura finish acabado |
| ivasil primer s pag. 81 | ivasil fondo pag.77 | ivasil pittura pag. 56 oppure ivasil intonachino pag. 65 oppure rivasil pag. 64 |

mascherante uniformante decorativo - decorative uniform concealer - enmascaramiento uniformador decorativo

| | |
|---|-------------------------------|
| consolidamento / imprimitura consolidation/ priming consolidación / imprimación | finitura finish acabado |
| silofix pag. 80 | deco sand plus pag.57 |

fotocatalitico, autopulente - photocatalytic, self-cleaning - fotocatalítico, autolimpiante

| | |
|---|-------------------------------|
| consolidamento / imprimitura consolidation/ priming consolidación / imprimación | finitura finish acabado |
| silofix pag. 80 | superclean plus pag.53 |



fondi

fondi uniformanti

prodotti

rasofondo color

prime tech

rasofondo flex

ivasgum fondo

ivasil fondo



rasofondo color

scheda
tecnicadata
sheetficha
técnica

| fondo uniformante pigmentato | interno esterno | pigmented uniforming base coat | indoor outdoor | fondo uniformante pigmentado | interior exterior |
|---|--------------------|---|-------------------|---|----------------------|
| Fondo riempitivo uniformante a grana fine a base di resine acrililossaniche e farine di quarzo in dispersione acquosa. Ideale come mano di fondo per idropitture al fine di uniformare gli assorbimenti e la tenuta dei colori. Caratterizzato da ottimo potere riempitivo, elevata copertura, elevata traspirabilità. Per uso professionale. | | Uniforming filler base coat based on acrylic resins and quartz flours in water dispersion, suitable for uniforming old patched plasters or for making smooth skimmed surfaces rough. Ideal as a base coat for water-based paints. Characterized by excellent filling power, high coverage and high breathability. For professional use. | | Fondo de relleno uniformante a base de resinas acrílicas y harinas de cuarzo en dispersión acuosa, indicado para uniformar enfoscados viejos reparados o para dar rugosidad a superficies enrasadas lisas. Ideal como capa de fondo para pinturas al agua. Caracterizado por su excelente capacidad de relleno, alto nivel cubriente y alta transpirabilidad. Para uso profesional. | |
| Granulometria: 75 µ Attrezzatura: pennello, rullo a pelo corto Diluizione: acqua - 15-20% Resa (2 mani): 3-4 m ² /l - Per confezione (14 l): 56 m ² Colore: bianco e colorato | | Particle size: 75 µ Equipment: brush, roller Dilution: water - 15-20% Coverage (2 coats): 3-4 m ² /l - Per packaging (14 l): 56 m ² Color: white and colored | | Granulometría: 75 µ Herramientas: brocha, rodillo a pelo corto Dilución: agua - 15-20% Rendimiento (2 capas): 3-4 m ² /l - Por envase (14 l): 56 m ² Color: blanco y colorido | |

| tecniche | certificazioni | proprietà | tecnologie |
|--|----------------|-----------|------------|
|     | | | |

prime tech

scheda
tecnicadata
sheetficha
técnica

| fondo all'acqua liscio opaco - pronto uso | interno | water-based, smooth matt base coat with pigments | indoor | fondo al agua liso mate pigmentado | interiores |
|---|---------|--|--------|---|------------|
| Fondo all'acqua extrafine opaco pronto uso a base di resine vinilversatiche, cariche minerali inerti, pigmenti selezionati. Uniforma la superficie del supporto al fine di ottimizzare l'applicazione del prodotto di finitura. Ideale come mano di fondo per cartongesso per successive finiture linea idropitture, lavabili e idrosmalti. Si consiglia applicazione di idoneo primer su supporti sfarinanti. Per uso professionale. | | Extra-fine water-based matt base coat containing vinilversatic resins, inert mineral fillers and selected pigments. It smooths out the surface of the substrate, thus optimizing application of the topcoat. Ideal for plasterboard after a suitable primer has been applied. We recommend the application of suitable primer on flakes. For professional use. | | Fondo al agua extrafino mate a base de resinas vinilversatic, cargas minerales inertes, pigmentos seleccionados. Uniforma la superficie del soporte a fin de optimizar la aplicación del producto de acabado. Ideal para cartón-yeso previa aplicación de una imprimación adecuada. Se recomienda la aplicación de cebadores adecuados en soportes con desintegración pulverulenta. Para uso profesional. | |
| Granulometria: 45 µ Attrezzatura: pennello, rullo, airless Diluizione: pronto uso Resa (1 mano): 5-6 m ² /l - Per confezione (14 l): 84 m ² Colore: solo bianco | | Particle size: 45 µ Equipment: brush, roller, airless Dilution: ready to use Coverage (1 coat): 5-6 m ² /l - Per packaging (14 l): 84 m ² Color: only white | | Granulometría: 45 µ Herramientas: brocha, rodillo, pistola pulverizadora Dilución: listo para usar Rendimiento (1 capa): 5-6 m ² /l - Por envase (14 l): 84 m ² Color: solo blanco | |

| tecniche | certificazioni | proprietà | tecnologie |
|--|----------------|-----------|------------|
|      | | | |

rasofondo flex



scheda
tecnica



data
sheet



ficha
técnica



| fondo riempitivo uniformante polisilossanico | interno esterno | polysiloxanic uniforming filler base coat | indoor outdoor | fondo de relleno uniformante polisiloxánico | interior exterior |
|---|-----------------|--|----------------|---|-------------------|
| Rivestimento di fondo deformabile a base di resine acrilisilossaniche elastomeriche in dispersione acquosa granulometria 0.5mm. Possiede elevata flessibilità, elevata traspirabilità, basso assorbimento d'acqua, ottimo potere riempitivo ed elevata copertura. Ideale per uniformare la granulometria dei supporti e in esterno per superfici microcavillate. Per uso professionale. | | Deformable base coat containing acrylic-siloxane-elastomeric resins in water dispersion with 0.5mm grain size. Offers great flexibility, high breathability, low water absorption, superb filling and high coverage. Ideal to even out of the particle size of the substrates and outdoors for surfaces presenting micro-cracks. For professional use. | | Revestimiento de fondo deformable a base de resinas acrilisiloxánicas elastoméricas en dispersión acuosa con granulometría de 0,5 mm. Posee una elevada flexibilidad, alta transpirabilidad, baja absorción de agua, excelente capacidad de relleno y alto nivel cubriente. Ideal para dar uniformidad a la granulometría de los soportes y exteriores para superficies microcuarateadas. Para uso profesional. | |
| Granulometria: 0,5 mm Attrezzatura: pennello, rullo a pelo corto Diluizione: acqua - 12-15% Resa (1 mano): 3,5-4 m ² /l - Per confezione (14 l): 56 m ² Colore: solo bianco | | Particle size: 0,5 mm Equipment: brush, roller Dilution: water - 12-15% Coverage (1 coat): 3,5-4 m ² /l - Per packaging (14 l): 56 m ² Color: only white | | Granulometría: 0,5 mm Herramientas: brocha, rodillo a pelo corto Dilución: agua - 12-15% Rendimiento (1 capa): 3,5-4 m ² /l - Por envase (14 l): 56 m ² Color: solo blanco | |

| tecniche | certificazioni | proprietà | tecnologie |
|--------------------------------|----------------|-----------|------------|
| WATER BASED BRUSH ROLLER | | | flex 3 |

ivasgum fondo



scheda
tecnica



data
sheet



ficha
técnica



| fondo uniformante elastomerico | esterno | uniforming elastomeric base coat | outdoor | fondo uniformante elastomérico | exterior |
|---|---------|--|---------|--|----------|
| Rivestimento di fondo riempitivo elastomerico. Possiede elevate resistenze meccaniche unite ad un'elevata resistenza agli shock termici. La notevole elasticità riduce i rischi di cavillature e screpolature. Abbinato alla rete Armatex Micro è utilizzato come ciclo elastomerico Ivas. Per uso professionale. | | Elastomeric filler base coat. High resistance, both mechanical and to abrupt changes in temperature. Its remarkable elasticity reduces the risk of cracks and fissures. In combination with Armatex Micro mesh, it is used as an Ivas elastomeric process. For professional use. | | Revestimiento de fondo de relleno elastomérico. Dotado de altas resistencias mecánicas unidas a resistencia a los choques térmicos. Su notable elasticidad reduce los riesgos de cuarteados y grietas. Unido a la malla Armatex Micro se utiliza como ciclo elastomérico Ivas. Para uso profesional. | |
| Granulometria: 75 µ Attrezzatura: pennello, rullo a pelo corto Diluizione: acqua - max 5% o tal quale Resa (2 mani): 2,5-3 m ² /l - Per confezione (14 l): 42 m ² Colore: solo bianco | | Particle size: 75 µ Equipment: brush, roller Dilution: water - max 5% o tal quale Coverage (2 coats): 2,5-3 m ² /l - Per packaging (14 l): 42 m ² Color: only white | | Granulometría: 75 µ Herramientas: brocha, rodillo Dilución: agua - max 5% o tal quale Rendimiento (2 capas): 2,5-3 m ² /l - Por envase (14 l): 42 m ² Color: solo blanco | |

| tecniche | certificazioni | proprietà | tecnologie |
|--------------------------------|----------------|-----------|------------|
| WATER BASED BRUSH ROLLER | | | flex 5 |

ivasil fondo



scheda
tecnica



data
sheet



ficha
técnica



| fondo uniformante ai silicati | interno esterno | Uniforming silicate base coat | indoor outdoor | fondo uniformante con silicatos | interior exterior |
|--|-----------------|--|----------------|---|-------------------|
| Fondo riempitivo uniformante ai silicati per cicli con elevata traspirabilità al vapore. Particolarmente idoneo per uniformare vecchi intonaci rappezzati, per supporti con esistenti pitture organiche. Ideale come fondo per finiture minerali. Per uso professionale. | | Uniforming silicate filler base coat for mineral processes offering high vapour breathability. Particularly suitable for smoothing out old, patched plasters, for substrates with old organic paints. For professional use. | | Fondo de relleno uniformante con silicatos para ciclos minerales de gran transpirabilidad al vapor. Particolarmente idoneo para dar uniformidad a enfoscados viejos con reparaciones y para soportes con pinturas orgánicas preexistentes. | |
| Granulometria: 0,35 mm Attrezzatura: pennello, rullo Diluizione: acqua/Ivasil Primer S - 20-25% Resa (1 mano): 3,5-4 m ² /l - Per confezione (14 l): 56 m ² Colore: solo bianco | | Particle size: 0,35 mm Equipment: brush, roller Dilution: water/Ivasil Primer S - 20-25% Coverage (1 coat): 3,5-4 m ² /l - Per packaging (14 l): 56 m ² Color: only white | | Granulometría: 0,35 mm Herramientas: brocha, rodillo Dilución: agua/Ivasil Primer S - 20-25% Rendimiento (1 capa): 3,5-4 m ² /l - Por envase (14 l): 56 m ² Color: solo blanco | |

| tecniche | certificazioni | proprietà | tecnologie |
|--------------------------------|----------------|-----------|------------|
| WATER BASED BRUSH ROLLER | | | silicate 3 |

fissativ

prodotti

primacril

silofix

nitrofix

acrilica 100

bloccafumo

ivasil primer s

vi

primacril

scheda
tecnicadata
sheetficha
técnica

| fissativo all'acqua ad alta penetrazione | interno esterno | high penetrating, water-based fixative | indoor outdoor | fijador al agua de alto poder penetrante | interior exterior |
|--|--------------------|---|-------------------|--|----------------------|
| Fissativo all'acqua ad altissima penetrazione e resistenza agli alcali, formulato per ottenere un'alta protezione su intonaci anche sfarinanti e per uniformare gli assorbimenti. Particolarmente indicato sui supporti in cartongesso. Per uso professionale. | | Water-based fixative with utmost penetration and resistance to alkalis, formulated for superb protection on plasters, both indoor and outdoor (including chalky plasters), and to ensure uniform absorption. Particularly suitable for plasterboard substrates. For professional use. | | Fijador al agua de máximo poder penetrante, resistente a los álcalis, formulado para obtener una gran protección sobre enfoscados, incluso con desintegración pulverulenta y para uniformar las absorciones. Particolarmente indicado sobre soportes en cartón-yeso. Para uso profesional. | |
| Attrezzatura: pennello, rullo Diluizione: acqua - 50% Resa (1 mano): 10-12 m ² /l - Per confezione (25 l): 300 m ² Colore: incolore | | Equipment: brush, roller Dilution: water - 50% Coverage (1 coat): 10-12 m ² /l - Per packaging (25 l): 300 m ² Color: colourless | | Herramientas: brocha, rodillo Dilución: agua - 50% Rendimiento (1 capa): 10-12 m ² /l - Por envase (25 l): 300 m ² Color: incoloro | |

tecniche



certificazioni

proprietà

tecnologie

silofix

scheda
tecnicadata
sheetficha
técnica

| fissativo all'acqua acril-siliconico | esterno | water-based acrylic-silicone fixative | outdoor | fijador al agua acril-silicónico | exterior |
|---|---------|--|---------|--|----------|
| Fissativo all'acqua acril-siliconico e polisilossani non filmogeno a particelle estremamente fini. Formulato per ottenere un'alta protezione su calcestruzzi e intonaci esterni anche sfarinanti dando ai supporti idrorepellenza superficiale e di profondità. Particolarmente indicato come primer per successivi cicli altamente traspiranti. Per uso professionale. | | Water-based acrylic-silicone fixative with extremely fine, non film-forming polysiloxanes particles. Formulated to achieve superb protection on concrete and external plasters, even when chalky. Makes the substrate water repellent both on the surface and inside. Particularly suitable as primer for subsequent, highly breathable processes. For professional use. | | Fijador al agua acril-silicónico con polisiloxanos, no filmógeno, de partículas extremadamente finas. Formulato para obtener una gran protección en hormigones y enfoscados externos, incluso con desintegración pulverulenta, dando a los soportes poder hidro-repelente en la superficie y en profundidad. Particolarmente indicado como imprimación para posteriores ciclos altamente traspirantes. Para uso profesional. | |
| Attrezzatura: pennello, rullo, airless Diluizione: acqua - 50% Resa (1 mano): 7-8 m ² /l - Per confezione (25 l): 200 m ² Colore: incolore | | Equipment: brush, roller, airless Dilution: water - 50% Coverage (1 coat): 7-8 m ² /l - Per packaging (25 l): 200 m ² Color: colourless | | Herramientas: brocha, rodillo, pistola pulverizadora Dilución: agua - 50% Rendimiento (1 capa): 7-8 m ² /l - Por envase (25 l): 200 m ² Color: incoloro | |

tecniche



certificazioni

proprietà

tecnologie

nitrofix

scheda
tecnicadata
sheetficha
técnica

| fissativo a solvente ad alta penetrazione | esterno | high penetrating solvent-based fixative | outdoor | fijador con disolvente de alto poder penetrante | exterior |
|---|---------|--|---------|---|----------|
| Fissativo trasparente alla Pliolite®, uniformante e consolidante ad elevatissima penetrazione che lo rendono particolarmente idoneo per applicazione su supporti murari esistenti, sfarinanti ed ammalorati. Per uso professionale. | | Transparent fixative with Pliolite®, smoothing and consolidating with very high penetration. Ideal for application on old, chalky, deteriorated wall substrates. For professional use. | | Fijador trasparente con Pliolite®, uniformante y consolidante de gran poder de penetración que lo hace particularmente idóneo para su aplicación sobre soportes de pared ya existentes, con desintegración pulverulenta y deteriorados. Para uso profesional. | |
| Attrezzatura: pennello, rullo Diluizione: Diluente Nitro Antinebbia - 10% Resa (1 mano): 8-10 m ² /l - Per confezione (25 l): 250 m ² Colore: incolore | | Equipment: brush, roller Dilution: Diluente Nitro Antinebbia - 10% Coverage (1 coat): 8-10 m ² /l - Per packaging (25 l): 250 m ² Color: colourless | | Herramientas: brocha, rodillo Dilución: Diluente Nitro Antinebbia - 10% Rendimiento (1 capa): 8-10 m ² /l - Por envase (25 l): 250 m ² Color: incoloro | |

tecniche



certificazioni

proprietà

tecnologie

acrilica 100



scheda
tecnica



data
sheet



ficha
técnica



| fissativo all'acqua ad alta resa | interno esterno | high coverage, water-based fixative | indoor outdoor | fijador al agua de alto rendimiento | interior exterior |
|--|-----------------|--|----------------|--|-------------------|
| <p>Fissativo all'acqua ad alta resa a base di microemulsioni acriliche che conferiscono un alto potere consolidante. Particolarmente indicato suintonaci e pitture esistenti. La Classe TVOC A+ lo rende idoneo per ottemperare i protocolli Leed Breeam. Per uso professionale.</p> | | <p>High coverage, water-based fixative with acrylic micro-emulsions that impart high consolidating power. Particularly suitable on old plasters and paints. Classified TVOC A+, it complies with Leed Breeam protocols. For professional use.</p> | | <p>Fijador al agua de alto rendimiento a base de microemulsiones acrílicas que le proporcionan una gran capacidad consolidante. Particolarmente indicado sobre enfoscados y pinturas ya existentes. La Clase TVOC A+ la hace idónea para cumplir con los protocolos Leed Breeam. Para uso profesional.</p> | |
| <p>Attrezzatura: pennello, rullo Diluizione: acqua - per impregnazione 400% - per finiture 100-300% Resa prodotto diluito (1 mano): 40-50 m²/l - Per confezione (25 l): 1250 m² Colore: incolore</p> | | <p>Equipment: brush, roller Dilution: water - per impregnazione 400% - per finiture 100-300% Coverage diluted product (1 coat): 40-50 m²/l - Per packaging (25 l): 1250 m² Color: colourless</p> | | <p>Herramientas: brocha, rodillo Dilución: agua - para impregnación 400% - para acabados 100-300% Rendimiento producto diluido (1 capa): 40-50 m²/l - Por envase (25 l): 1250 m² Color: incoloro</p> | |

| tecniche | certificazioni | proprietà | tecnologie |
|--------------------------------|----------------|-----------|------------|
| WATER BASED BRUSH ROLLER | | | |

bloccafumo



scheda
tecnica



data
sheet



ficha
técnica



| fissativo all'acqua antifumo | interno | smoke suppressant water-based fixative | indoor | fijador al agua antihumo | interiores |
|---|---------|--|--------|--|------------|
| <p>Fissativo trasparente antifumo formulato con specifici leganti in soluzione acquosa che lo rendono idoneo per il trattamento di ambienti con ingiallimenti e macchie di fumo dovuti a stufe caminetti e cucine. particolarmente idoneo come primer per successiva applicazione di Idrofumo. Per uso professionale.</p> | | <p>Transparent smoke suppressant fixative formulated with specific binders in a water-based solution. Suitable for the treatment of areas subject to yellowing and smoke stains from heaters, fireplaces and kitchens. Ideal as primer for subsequent application of Idrofumo. For professional use.</p> | | <p>Fijador transparente antihumo formulado con aglomerantes específicos en solución acuosa que lo hacen idóneo para el tratamiento de espacios con amarilleo y manchas de humo debidas a estufas, chimeneas y cocinas. Particularmente idóneo como imprimación para la posterior aplicación de Idrofumo. Para uso profesional.</p> | |
| <p>Attrezzatura: pennello, rullo, airless Diluizione: acqua - 20% Resa (1 mano): 6 m²/l - Per confezione (25 l): 150 m² Colore: incolore</p> | | <p>Equipment: brush, roller, airless Dilution: water - 20% Coverage (1 coat): 6 m²/l - Per packaging (25 l): 150 m² Color: colourless</p> | | <p>Herramientas: brocha, rodillo, pistola pulverizadora Dilución: agua - 20% Rendimiento (1 capa): 6 m²/l - Por envase (25 l): 150 m² Color: incoloro</p> | |

| tecniche | certificazioni | proprietà | tecnologie |
|--------------------------------|----------------|-----------|------------|
| WATER BASED BRUSH ROLLER | | | |

ivasil primer s



scheda
tecnica



data
sheet



ficha
técnica



| fissativo all'acqua ai silicati | esterno | water-based silicate fixative | outdoor | fijador al agua acrilisilicónico | exterior |
|--|---------|---|---------|---|----------|
| <p>Fissativo all'acqua per cicli a base di silicati. Particolarmente idoneo per consolidare intonaci esistenti, rappezzati e per supporti con vecchie pitture organiche. Può essere utilizzato come diluente in Ivasil Pittura e Ivasil Fondo. Conforme alla norma DIN 18363. Per uso professionale.</p> | | <p>Water-based silicate fixative for mineral processes. Particularly suitable for consolidating old, patched plasters and substrates with old organic paints. Can also be used as thinner for Ivasil Pittura and Ivasil Fondo. Conforms to DIN 18363. For professional use.</p> | | <p>Fijador al agua para ciclos minerales a base de silicatos. Particolarmente idóneo para consolidar enfoscados ya existentes, reparados y para soportes con pinturas orgánicas viejas. Puede utilizarse como diluyente con Ivasil pintura e Ivasil Fondo. Conforme a la norma DIN 18363. Para uso profesional.</p> | |
| <p>Attrezzatura: pennello, rullo Diluizione: pronto all'uso Resa (1 mano): 7-8 m²/l - Per confezione (25 l): 190 m² Colore: incolore</p> | | <p>Equipment: brush, roller Dilution: ready to use Coverage (1 coat): 7-8 m²/l - Per packaging (25 l): 190 m² Color: colourless</p> | | <p>Herramientas: brocha, rodillo Dilución: listo para usar Rendimiento (1 capa): 7-8 m²/l - Por envase (25 l): 190 m² Color: incoloro</p> | |

| tecniche | certificazioni | proprietà | tecnologie |
|--------------------------------|----------------|-----------|------------|
| WATER BASED BRUSH ROLLER | | MINERAL | SILICATE 5 |



stucco

prodotti

ivastucco

elastucco

novostucco

stucco in polvere



ivastucco

scheda
tecnicadata
sheetficha
técnica

| stucco in pasta per rasature | interno | skimming plaster in paste form | indoor | emplaste en pasta para enrasados | interiores |
|--|---------|---|--------|--|------------|
| Stucco fine per rasature e riempimento, a base di resine sintetiche in dispersione acquosa e riempitivi selezionati, di buona scorrevolezza e spatolabilità, non dà luogo a fessurazioni. Per uso professionale. | | Fine skimming and filling plaster based on synthetic resins dispersed in water and selected fillers. Good flow and spreadability. It does not cause cracks. For professional use. | | Emplaste fino para enrasados y relleno, a base de resinas sintéticas en dispersión acuosa y rellenos seleccionados, con buenas capacidades de deslizamiento y facilidad para la aplicación con espátula, no causa fisuras. Para uso profesional. | |
| Attrezzatura: spatola Diluizione: pronto all'uso Resa: 1 kg/m ² per mm di spessore Colore: solo bianco | | Equipment: spatula Dilution: ready to use Coverage: 1 kg/m ² per mm of thickness Color: only white | | Herramientas: espátula Dilución: listo para usar Rendimiento: 1 kg/m ² per mm de espesor Color: solo blanco | |

| tecniche | certificazioni | proprietà | tecnologie |
|--|----------------|-----------|------------|
|  WATER BASED  TROWEL  READY TO USE | | | |

elastucco

scheda
tecnicadata
sheetficha
técnica

| stucco rasante elastico riempitivo | esterno | elastic filler skimming plaster | outdoor | emplaste de enrasado elástico de relleno | exterior |
|--|---------|--|---------|--|----------|
| Stucco a base di elastomeri in emulsione acquosa, pigmenti resistenti agli alcali ed alla luce, fibre naturali e sintetiche, extenders. Impiegabile come rasante riempitivo per esterni, elastico ed impermeabile, appositamente formulato per riempimento di fessurazioni o crepe, armabile con Armatex micro. Per uso professionale. | | Elastomer-based filler in water emulsion, it contains alkal- and light-resistant pigments, natural and synthetic fibres, extenders. Can be used as elastic, waterproofing filler/skim coat to fill cracks or fissures, for outdoor use. Specially formulated for skimming of plasters with cracks and fissures. Can be used with Armatex micro. For outdoor use. For professional use. | | Emplaste a base de elastómeros en emulsión acuosa, pigmentos resistentes a los álcalis y a la luz, fibras naturales y sintéticas, extenders. Puede emplearse como emplaste de enrasado y de relleno para exteriores, elástico e impermeable, específicamente formulado para relleno de fisuras o grietas; puede armarse con Armatex micro. Para uso profesional. | |
| Attrezzatura: spatola Diluizione: pronto all'uso Resa: 1,4 kg/m ² per mm di spessore Colore: solo bianco | | Equipment: spatula Dilution: ready to use Coverage: 1,4 kg/m ² per mm of thickness Color: only white | | Herramientas: espátula Dilución: listo para usar Rendimiento: 1,4 kg/m ² per mm de espesor Color: solo blanco | |

| tecniche | certificazioni | proprietà | tecnologie |
|--|----------------|-----------|--|
|  WATER BASED  TROWEL  READY TO USE | | |  flex 4 |



coloranti

coloranti universali ri



scheda
tecnica



data
sheet



ficha
técnica



| | interno | | indoor | | interiores |
|--|---|--|---|--|--|
| | Coloranti ad alta concentrazione di pigmenti organici ad altissimo potere colorante. Si ottengono tonalità intense con poco colorante, utilizzabili sia in prodotti all'acqua che in prodotti a solvente. | | Dyes with high concentration of organic pigments with very high coloring power. Intense shades with little dye are obtained, usable both in water products and in solvent products. | | Colorantes con alta concentración de pigmentos orgánicos con muy alto poder colorante. Se obtienen tonalidades intensas con poco colorante, que se puede utilizar tanto en agua productos como en productos a base de disolventes. |
| | Idoneità prodotti: pitture o smalti Diluizione: pronto all'uso Quantità massima utilizzabile: 6% in volume sul prodotto finito Colore: colori organici | | Idoneità products: paint or enamel Dilution: ready to use Quantità massima utilizzabile: 6% in volume sul product finito Color: organic colors | | Idoneità productos: pinturas o esmaltes Dilución: listo para usar Cantidad máxima utilizable: 6% en volumen sobre el producto terminado color: colores orgánicos |

| tecniche | | | | certificazioni | | | | proprietà | | | | tecnologie | | | |
|-------------|-------|--------|--------------|----------------|--|--|--|-----------|--|--|--|------------|--|--|--|
| | | | | | | | | | | | | | | | |
| WATER BASED | BRUSH | ROLLER | READY TO USE | | | | | | | | | | | | |

coloranti universali re



scheda
tecnica



data
sheet



ficha
técnica



| | esterno | | outdoor | | exterior |
|--|---|--|---|--|--|
| | Coloranti ad alta concentrazione di pigmenti organici ed inorganici ad altissimo potere colorante. Si ottengono tonalità intense con poco colorante, utilizzabili sia in prodotti all'acqua che in prodotti a solvente. | | Dyes with high concentration of organic and inorganic pigments with very high coloring power. Intense shades with little dye are obtained, usable both in water products and in solvent products. | | Colorantes con alta concentración de pigmentos orgánicos con muy alto poder colorante. Se obtienen tonalidades intensas con poco colorante, que se puede utilizar tanto en agua productos como en productos a base de disolventes. |
| | Idoneità prodotti: pitture o smalti Diluizione: pronto all'uso Quantità massima utilizzabile: 6% in volume sul prodotto finito Colore: colori organici e inorganici | | Idoneità products: paint or enamel Dilution: ready to use Quantità massima utilizzabile: 6% in volume sul product finito Color: organic and inorganic colors | | Idoneità productos: pinturas o esmaltes Dilución: listo para usar Cantidad máxima utilizable: 6% en volumen sobre el producto terminado color: colores orgánicos e inorgánicos |

| tecniche | | | | certificazioni | | | | proprietà | | | | tecnologie | | | |
|-------------|-------|--------|--------------|----------------|--|--|--|-----------|--|--|--|------------|--|--|--|
| | | | | | | | | | | | | | | | |
| WATER BASED | BRUSH | ROLLER | READY TO USE | | | | | | | | | | | | |



smalti

smalti ultrafini all'acqua

prodotti

real matt
real satin
real gloss
real tech



h2o

real matt

scheda
tecnicadata
sheetficha
técnica

| smalto opaco all'acqua | interno esterno | matt water-based enamel | indoor outdoor | esmalte mate al agua | interior exterior |
|---|-----------------|---|----------------|---|-------------------|
| <p>Smalto opaco all'acqua, di ottima pennellabilità, dilatazione, brillantezza. A base di resine acriliche, pigmenti idonei, additivi, inodore, non ingiallente, di ottima aderenza su supporti difficili conferendo ottima resistenza alle abrasioni agli agenti atmosferici. Specifico come finitura ultrafine per legno, metalli. La Classe TVOC A+ lo rende idoneo per ottemperare ai protocolli CAM, Leed Breeam. Per uso professionale.</p> | | <p>Matt water-based enamel offering superb brushability, expansion and shine. Based on acrylic resins, suitable pigments and additives. Odourless, non yellowing, provides excellent adhesion on difficult substrates and superb resistance to abrasion and atmospheric agents. Specific as an ultra-fine topcoat for wood and metals. HACCP certified. Classified TVOC A+, it complies with Leed Breeam protocols. For professional use.</p> | | <p>Esmalte mate al agua, de excelente facilidad de aplicación con brocha, dilatación, brillo. A base de resinas acrílicas, pigmentos adecuados, aditivos; inodoro, no amarillea, de excelente adherencia en soportes difíciles, proporciona una excelente resistencia a la abrasión y a los agentes atmosféricos. Especifico como acabado ultrafino para madera, metales. Certificado HACCP. La Clase TVOC A+ la hace idónea para cumplir con los protocolos Leed Breeam. Para uso profesional.</p> | |
| <p>Attrezzatura: pennello, rullo, airless Diluizione: acqua - max 5% Resa (2 mani): 6,5-7 m²/l - Per confezione (5 l): 35 m² Colore: bianco e colorato</p> | | <p>Equipment: brush, roller, airless Dilution: water - max 5% Coverage (2 coats): 6,5-7 m²/l - Per packaging (5 l): 35 m² Color: white and colored</p> | | <p>Herramientas: brocha, rodillo, pistola pulverizadora Dilución: agua - max 5% Rendimiento (2 capas): 6,5-7 m²/l - Por envase (5 l): 35 m² Color: blanco y colorido</p> | |

| tecniche | certificazioni | proprietà | tecnologie |
|----------|----------------|-----------|------------|
| | | | |

real satin

scheda
tecnicadata
sheetficha
técnica

| smalto satinato all'acqua | interno esterno | satin water-based enamel | indoor outdoor | esmalte satinado al agua | interior exterior |
|--|-----------------|--|----------------|---|-------------------|
| <p>Smalto satinato all'acqua, di ottima pennellabilità, dilatazione, brillantezza. A base di resine acriliche, pigmenti idonei, additivi, inodore, non ingiallente, di ottima aderenza su supporti difficili conferendo ottima resistenza alle abrasioni agli agenti atmosferici. Specifico come finitura ultrafine per legno, metalli. La Classe TVOC A+ lo rende idoneo per ottemperare ai protocolli CAM, Leed Breeam. Per uso professionale.</p> | | <p>Satin water-based enamel offering superb brushability, expansion and shine. Based on acrylic resins, suitable pigments and additives. Odourless, non yellowing, provides excellent adhesion on difficult substrates and superb resistance to abrasion and atmospheric agents. Specific as an ultra-fine topcoat for wood and metals. HACCP certified. Classified TVOC A+, it complies with Leed Breeam protocols. For professional use.</p> | | <p>Esmalte satinado al agua, de excelente facilidad de aplicación con brocha, dilatación, brillo. A base de resinas acrílicas, pigmentos adecuados, aditivos; inodoro, no amarillea, de excelente adherencia en soportes difíciles, proporciona una excelente resistencia a la abrasión y a los agentes atmosféricos. Especifico como acabado ultrafino para madera, metales. Certificado HACCP. La Clase TVOC A+ la hace idónea para cumplir con los protocolos Leed Breeam. Para uso profesional.</p> | |
| <p>Attrezzatura: pennello, rullo, airless Diluizione: acqua - max 5% Resa (2 mani): 6,5-7 m²/l - Per confezione (5 l): 35 m² Colore: bianco e colorato</p> | | <p>Equipment: brush, roller, airless Dilution: water - max 5% Coverage (2 coats): 6,5-7 m²/l - Per packaging (5 l): 35 m² Color: white and colored</p> | | <p>Herramientas: brocha, rodillo, pistola pulverizadora Dilución: agua - max 5% Rendimiento (2 capas): 6,5-7 m²/l - Por envase (5 l): 35 m² Color: blanco y colorido</p> | |

| tecniche | certificazioni | proprietà | tecnologie |
|----------|----------------|-----------|------------|
| | | | |

real gloss



scheda
tecnica



data
sheet



ficha
técnica



| smalto lucido all'acqua | interno esterno | glossy water-based enamel | indoor outdoor | esmalte brillante al agua | interior exterior |
|--|-----------------|---|----------------|--|-------------------|
| <p>Smalto lucido all'acqua, di ottima pennellabilità, dilatazione, brillantezza. A base di resine acriliche, pigmenti idonei, additivi, inodore, non ingiallente, di ottima aderenza su supporti difficili conferendo ottima resistenza alle abrasioni agli agenti atmosferici. Specifico come finitura ultrafine per legno, metalli. La Classe TVOC A+ lo rende idoneo per ottemperare ai protocolli CAM, Leed Breeam. Per uso professionale.</p> | | <p>Glossy water-based enamel offering superb brushability, expansion and gloss. Based on acrylic resins, suitable pigments and additives. Odourless, non yellowing, provides excellent adhesion on difficult substrates and superb resistance to abrasion and atmospheric agents. Specific as an ultra-fine topcoat for wood and metals. HACCP certified. Classified TVOC A+, it complies with Leed Breeam protocols. For professional use.</p> | | <p>Esmalte brillante al agua, de excelente facilidad de aplicación con brocha, dilatación, brillo. A base de resinas acrílicas, pigmentos adecuados, aditivos; inodoro, no amarillea, de excelente adherencia en soportes difíciles, proporciona una excelente resistencia a la abrasión y a los agentes atmosféricos. Especifico como acabado ultrafino para madera, metales. Certificado HACCP. La Clase TVOC A+ la hace idónea para cumplir con los protocolos Leed Breeam. Para uso profesional.</p> | |
| <p>Attrezzatura: pennello, rullo, airless Diluizione: acqua - max 5% Resa (2 mani): 6,5-7 m²/l - Per confezione (5 l): 35 m² Colore: bianco e colorato</p> | | <p>Equipment: brush, roller, airless Dilution: water - max 5% Coverage (2 coats): 6,5-7 m²/l - Per packaging (5 l): 35 m² Color: white and colored</p> | | <p>Herramientas: brocha, rodillo, pistola pulverizadora Dilución: agua - max 5% Rendimiento (2 capas): 6,5-7 m²/l - Por envase (5 l): 35 m² Color: blanco y colorido</p> | |

| tecniche | certificazioni | proprietà | tecnologie |
|----------|----------------|-----------|------------|
| | | | |

real tech



scheda
tecnica



data
sheet



ficha
técnica



| finitura all'acqua per ceramica e clinker | interno esterno | water-based topcoat for ceramics and clinker | indoor outdoor | acabado al agua para cerámica y clinker | interior exterior |
|--|-----------------|---|----------------|--|-------------------|
| <p>Smalto all'acqua a base di resine acriliche, cariche e additivi in dispersione acquosa dall'aspetto satinato. Permette di modificare esteticamente le finiture ceramiche esistenti come bagni e cucine. Real tech si applica direttamente su piastrelle o clinker senza ausilio di primer, pronto uso. Destinato a pareti verticali e orizzontali di piccole dimensioni e se moderatamente pedonabili. La Classe TVOC A+ lo rende idoneo per ottemperare ai protocolli CAM, Leed Breeam. Per uso professionale.</p> | | <p>Water-based enamel with acrylic resins, extenders and additives dispersed in water. Satin finish. Makes it possible to change the look of existing ceramic bathroom and kitchen tiles. Real tech comes ready to use and is applied directly on the tiles or clinker. Does not require a primer. Intended for use on small vertical and horizontal surfaces and those subject to moderate foot traffic. Classified TVOC A+, it complies with Leed Breeam protocols. For professional use.</p> | | <p>Esmalte al agua a base de resinas acrílicas, cargas y aditivos en dispersión acuosa de aspecto satinado. Permite modificar estéticamente los acabados cerámicos ya existentes de baños y cocinas. Real tech se aplica directamente sobre baldosas o clinker sin recurrir a imprimación, listo para usar. Destinado a paredes verticales y horizontales de pequeño tamaño, sujetas a un tránsito peatonal moderado. La Clase TVOC A+ la hace idónea para cumplir con los protocolos Leed Breeam. Para uso profesional.</p> | |
| <p>Attrezzatura: pennello, rullo, airless Diluizione: acqua - max 5% Resa (2 mani): 6,5-7 m²/l - Per confezione (5 l): 40 m² Colore: bianco e colorato</p> | | <p>Equipment: brush, roller, airless Dilution: water - max 5% Coverage (2 coats): 6,5-7 m²/l - Per packaging (5 l): 40 m² Color: white and colored</p> | | <p>Herramientas: brocha, rodillo, pistola pulverizadora Dilución: agua - max 5% Rendimiento (2 capas): 6,5-7 m²/l - Por envase (5 l): 40 m² Color: blanco y colorido</p> | |

| tecniche | certificazioni | proprietà | tecnologie |
|----------|----------------|-----------|------------|
| | | | |



smalti

smalti alte prestazioni

prodotti

crystal

crystal sx

aderlac hq

micafer



crystal

scheda
tecnicadata
sheetficha
técnica

| smalto alchidico uretano lucido | interno esterno | shiny enamel containing alkyd resins with urethane | indoor outdoor | esmalte alquídico uretánico brillante | interior exterior |
|---|--------------------|---|-------------------|---|----------------------|
| Smalto alchidico uretanico lucido supercoprente extrafine. Possiede caratteristiche eccezionali di adesione, pienezza, durezza superficiale, resistenza agli agenti atmosferici e alla luce. Ideale per proteggere e decorare supporti metallici e legno in atmosfera marina ed industriale. Dotato di eccellente pennellabilità, dilatazione ed elevata resistenza alle colature. Per uso professionale. | | Shiny alkyd enamel with urethane, extra-fine, offering superb coverage. Extraordinary adhesion, fullness, surface hardness, resistance to the weather and light. Ideal for protecting and decorating metal and wood substrates in marine and industrial atmospheres. Excellent brushability, expansion and high resistance to dripping. For professional use. | | Esmalte alquídico brillante supercoprente extrafino. Posee características excepcionales de adhesión, cuerpo, dureza superficial, resistencia a los agentes atmosféricos y a la luz. Ideal para proteger y decorar soportes metálicos y madera en atmósferas marinas e industriales. Dotado de excelente facilidad de aplicación con brocha, dilatación y alta resistencia a la formación de goterones. Para uso profesional. | |
| Attrezzatura: pennello, rullo, airless Diluizione: pronto all'uso Resa (2 mani): 6,5-7 m ² /l - Per confezione (10 l): 65 m ² Colore: bianco e colorato | | Equipment: brush, roller, airless Dilution: ready to use Coverage (2 coats): 6,5-7 m ² /l - Per packaging (10 l): 65 m ² Color: white and colored | | Herramientas: brocha, rodillo, pistola pulverizadora Dilución: listo para usar Rendimiento (2 capas): 6,5-7 m ² /l - Por envase (10 l): 65 m ² Color: blanco y colorido | |

| tecniche | certificazioni | proprietà | tecnologie |
|----------|----------------|-----------|------------|
| | | | |

crystal sx

scheda
tecnicadata
sheetficha
técnica

| smalto alchidico uretano opaco | interno esterno | matt enamel containing alkyd resins with urethane | indoor outdoor | esmalte alquídico uretánico mate | interior exterior |
|--|--------------------|--|-------------------|--|----------------------|
| Smalto alchidico uretanico opaco supercoprente extrafine. Possiede caratteristiche eccezionali di adesione, pienezza, durezza superficiale, resistenza agli agenti atmosferici e alla luce. Ideale per proteggere e decorare supporti metallici e legno in atmosfera marina ed industriale. Dotato di eccellente pennellabilità, dilatazione ed elevata resistenza alle colature. Per uso professionale. | | Matt alkyd enamel with urethane, extra-fine, offering superb coverage. Extraordinary adhesion, fullness, surface hardness, resistance to the weather and light. Ideal for protecting and decorating metal and wood substrates in marine and industrial atmospheres. Excellent brushability, expansion and high resistance to dripping. For professional use. | | Esmalte alquídico mate supercoprente extrafino. Posee características excepcionales de adhesión, cuerpo, dureza superficial, resistencia a los agentes atmosféricos y a la luz. Ideal para proteger y decorar soportes metálicos y madera en atmósferas marinas e industriales. Dotado de excelente facilidad de aplicación con brocha, dilatación y alta resistencia a la formación de goterones. Para uso profesional. | |
| Attrezzatura: pennello, rullo, airless Diluizione: pronto all'uso Resa (2 mani): 6,5-7 m ² /l - Per confezione (10 l): 65 m ² Colore: bianco e colorato | | Equipment: brush, roller, airless Dilution: ready to use Coverage (2 coats): 6,5-7 m ² /l - Per packaging (10 l): 65 m ² Color: white and colored | | Herramientas: brocha, rodillo, pistola pulverizadora Dilución: listo para usar Rendimiento (2 capas): 6,5-7 m ² /l - Por envase (10 l): 65 m ² Color: blanco y colorido | |

| tecniche | certificazioni | proprietà | tecnologie |
|----------|----------------|-----------|------------|
| | | | |

aderlac hq



scheda
tecnica



data
sheet



ficha
técnica



| | | | | | |
|--|----------------|--|----------------|--|-----------------|
| smalto semilucido per lamiere zincate | esterno | semi-gloss enamel for galvanised sheet | outdoor | esmalte semibrillante para chapas galvanizadas | exterior |
| Smalto semilucido a base di resina acrilica per applicazione diretta su lamiere zincate altamente resistente agli agenti atmosferici ed alle atmosfere industriali, mantiene inalterate nel tempo le caratteristiche di impermeabilità, elasticità ed aderenza. Per uso professionale. | | Semi-gloss, acrylic resin-based enamel. Offers superb resistance to the weather and industrial atmospheres, maintaining its impermeability, elasticity and adherence unaltered in time. Direct application on galvanised sheets. For professional use. | | Esmalte semibrillante a base de resina acrílica altamente resistente a los agentes atmosféricos y a las atmósferas industriales, mantiene inalteradas con el paso del tiempo las características de impermeabilidad, elasticidad y adherencia. Aplicación directa sobre chapas galvanizadas. Para uso profesional. | |
| Attrezzatura: pennello, rullo, airless Diluizione: Diluente Sintetico - a pennello 3%, a airless 5% Resa (2 mani): 6 m ² /l - Per confezione (10 l): 60 m ² Colore: bianco e colorato | | Equipment: brush, roller, airless Dilution: Diluente Sintetico - brush 3%, a airless 5% Coverage (2 coats): 6 m ² /l - Per packaging (10 l): 60 m ² Color: white and colored | | Herramientas: brocha, rodillo, pistola pulverizadora Dilución: Diluente Sintetico - a brocha 3%, a pistola pulverizadora 5% Rendimiento (2 capas): 6 m ² /l - Por envase (10 l): 60 m ² Color: blanco y colorido | |

| | | | |
|-----------------|-----------------------|------------------|-------------------|
| tecniche | certificazioni | proprietà | tecnologie |
| | | | |

micafer



scheda
tecnica



data
sheet



ficha
técnica



| | | | | | |
|---|----------------|--|----------------|--|-----------------|
| smalto alchidico ferromicaceo | esterno | Ferromicaceous alkyd enamel | outdoor | esmalte alquídico ferromicáceo | exterior |
| Smalto alchidico con pigmenti a struttura lamellare con effetto ferromicaceo. Possiede ottime proprietà anticorrosive, elevata resistenza all'esterno, ottimo potere coprente e riempitivo, facile pennellabilità e distensione. La struttura lamellare del pigmento crea un'efficace barriera all'umidità ed ai raggi ultravioletti proteggendo il supporto dalla corrosione. Per uso professionale. | | Alkyd enamel with lamellar structure pigments that produce a micaceous iron oxide effect. Excellent anticorrosive properties, high outdoor resistance, excellent coverage and superb filling. Good brushability and spreadability. The lamellar pigment structure creates an effective barrier to moisture and ultraviolet radiation, protecting the substrate from corrosion and chalking. For outdoor use. For professional use. | | Esmalte alquídico con pigmentos de estructura laminar con efecto ferromicáceo. Posee excelentes propiedades anticorrosión, gran resistencia a la intemperie, óptima capacidad cubriente y de relleno, fácil aplicación y distensión con brocha. La estructura laminar del pigmento crea una eficaz barrera contra la humedad y los rayos ultravioleta, protegiendo el soporte de la corrosión y de la desintegración pulverulenta. Para uso profesional. | |
| Attrezzatura: pennello, airless Diluizione: Diluente Sintetico - a pennello 3%, a airless 5% Resa (2 mani): 5 m ² /l - Per confezione (10 l): 50 m ² Colore: bianco e colorato | | Equipment: brush, airless Dilution: Diluente Sintetico - a brush 3%, a airless 5% Coverage (2 coats): 5 m ² /l - Per packaging (10 l): 50 m ² Color: white and colored | | Herramientas: brocha, pistola pulverizadora Dilución: Diluente Sintetico - a brocha 3%, a pistola pulverizadora 5% Rendimiento (2 capas): 5 m ² /l - Por envase (10 l): 50 m ² Color: blanco y colorido | |

| | | | |
|-----------------|-----------------------|------------------|-------------------|
| tecniche | certificazioni | proprietà | tecnologie |
| | | | |



**antirug
fondi**

prodotti

fondo per legno

fondo H₂O per legno

primex hq

rusty

minio oleofenolico



ggini e

fondo per legno

scheda
tecnicadata
sheetficha
técnica

| | | | | | |
|--|----------------|--|---------------|--|-------------------|
| fondo riempitivo per legno a base solvente | interno | solvent-based wood filler base coat | indoor | fondo de relleno para madera con base disolvente | interiores |
| Fondo isolante ed uniformante a base solvente per elementi in legno per successive applicazioni di finiture coprenti. Possiede eccezionale copertura e punto di bianco. Maschera le rugosità del legno. Per uso professionale. | | Solvent-based insulating and levelling base coat to prepare wood items for subsequent application of opaque topcoats. Provides exceptional coverage and whiteness. Masks the roughness of wood. For professional use | | Fondo aislante y uniformante con base disolvente para elementos de madera para sucesivas aplicaciones de acabados cubrientes. Posee una excepcional capacidad cubriente y punto de blanco. Enmascara las rugosidades de la madera. Para uso profesional. | |
| Attrezzatura: pennello, rullo, airless Diluizione: Diluente Sintetico - max 5% Resa (1 mano): 10-12 m ² /l - Per confezione (10 l): 120 m ² Colore: solo bianco | | Equipment: brush, roller, airless Dilution: Diluente Sintetico - max 5% Coverage (1 coat): 10-12 m ² /l - Per packaging (10 l): 120 m ² Color: only white | | Herramientas: brocha, rodillo, pistola pulverizadora Dilución: Diluyente Sintetico - max 5% Rendimiento (1 capa): 10-12 m ² /l - Por envase (10 l): 120 m ² Color: solo blanco | |

| tecniche | | | | certificazioni | | | | proprietà | | | | tecnologie | | | |
|----------|--|--|--|----------------|--|--|--|-----------|--|--|--|------------|--|--|--|
| | | | | | | | | | | | | | | | |

fondo H₂O per legnoscheda
tecnicadata
sheetficha
técnica

| | | | | | |
|--|------------------------|---|-----------------------|---|--------------------------|
| fondo riempitivo per legno a base acqua | interno esterno | water-based wood filler base coat | indoor outdoor | fondo de relleno para madera con base de agua | interior exterior |
| Fondo isolante ed uniformante a base acqua per elementi in legno per successive applicazioni di finiture coprenti a base acqua. Possiede eccezionale copertura e punto di bianco. Maschera le rugosità del legno. Per uso professionale. | | Water-based insulating and levelling base coat to prepare wood items for subsequent application of water-based opaque topcoats. Provides exceptional coverage and whiteness. Masks the roughness of wood. For professional use | | Fondo aislante y uniformante con base de agua para elementos de madera para sucesivas aplicaciones de acabados cubrientes al agua. Posee una excepcional capacidad cubriente y punto de blanco. Enmascara las rugosidades de la madera. Para uso profesional. | |
| Attrezzatura: pennello, rullo, airless Diluizione: Acqua - pennello e rullo 5-7% = 50 ml ogni litro di prodotto, A spruzzo 10-12% = 100-120ml/l Resa: 9-10 m ² /l in funzione dell'assorbimento supporto Colore: solo bianco | | Equipment: brush, roller, airless Dilution: Water - brush and roller 5-7% = 50 ml per liter of product By spray 10-12% = 100-120ml / l Coverage: 9-10 m ² /l depending on the support absorption Color: only white | | Herramientas: brocha, rodillo, pistola pulverizadora Dilución: Agua - brocha y rodillo 5-7% = 50 ml por litro de producto, Por pulverización 10-12% = 100-120ml/l Rendimiento : 9-10C m ² /l dependiendo de la absorción del soporte Color: solo blanco | |

| tecniche | | | | certificazioni | | | | proprietà | | | | tecnologie | | | |
|----------|--|--|--|----------------|--|--|--|-----------|--|--|--|------------|--|--|--|
| | | | | | | | | | | | | | | | |

primex hq



scheda
tecnica



data
sheet



ficha
técnica



| | | | | | |
|---|------------------------|---|-----------------------|--|--------------------------|
| fondo pigmentato ad alta adesione | interno esterno | high adhesion pigmented topcoat | indoor outdoor | fondo pigmentado de gran capacidad de adhesión | interior exterior |
| Fondo monocomponente universale pigmentato, a base di resine acriliche in dispersione acquosa. Caratterizzato da elevato potere di adesione su supporti difficili e da ottima proprietà antiruggine. Può essere applicato su: lamiera zincata, plexiglass, pvc, alluminio e metalli ferrosi e non ferrosi. Per uso professionale. | | One-pack, pigmented base coat with acrylic resin-based dispersed in water. Offers high adhesion power on difficult substrates and excellent rustproofing properties. Can be applied on: galvanised sheet metal, plexiglass, PVC, aluminium and both ferrous and non-ferrous metals. For professional use. | | Fondo monocomponente universal pigmentado a base de resinas acrílicas en dispersión acuosa. Caracterizado por una gran capacidad de adhesión sobre soportes difíciles y por excelentes propiedades antióxido. Puede aplicarse sobre: chapa galvanizada, plexiglás, pvc, aluminio y metales ferrosos/no ferrosos. Para uso profesional. | |
| Attrezzatura: pennello, rullo, airless Diluizione: Acqua - max 10% Resa (1 mano): 8-10 m ² /l - Per confezione (2,5 l): 25 m ² Colore: bianco e colorato | | Equipment: brush, roller, airless Dilution: water - max 10% Coverage (1 coat): 8-10 m ² /l - Per packaging (2,5 l): 25 m ² Color: white and colored | | Herramientas: brocha, rodillo, pistola pulverizadora Dilución: agua - max 10% Rendimiento (1 capa): 8-10 m ² /l - Por envase (2,5 l): 25 m ² Color: blanco y colorido | |

| | | | |
|---|-----------------------|------------------|-------------------|
| tecniche | certificazioni | proprietà | tecnologie |
| WATER BASED BRUSH ROLLER AIRLESS | | | |

rusty



scheda
tecnica



data
sheet



ficha
técnica



| | | | | | |
|---|------------------------|--|-----------------------|---|--------------------------|
| fondo antiruggine sintetico opaco | interno esterno | mat synthetic rust proofing base coat | indoor outdoor | fondo antióxido sintético mate | interior exterior |
| Fondo antiruggine sintetico opaco, monocomponente ad alte prestazioni, con elevato potere di adesione e protezione. Dotato di ottima adesione su: acciaio, acciaio zincato sia a caldo che a freddo, vecchie verniciature opportunamente carteggiate. Ideale come fondo per successive verniciature con Crystal. Per uso professionale. | | One-pack, high-performance, synthetic rust proofing base coat with high adhesion and protection power. Has excellent adhesion on: steel, hot and cold galvanised steel, old paints suitably sanded. Matt finish. Ideal as a base for subsequent varnishing with Crystal. For professional use. | | Fondo antióxido sintético mate, monocomponente de altas prestaciones, con gran poder adhesivo y protección. Dotado de excelente adhesión sobre: acero, acero galvanizado, tanto en caliente como en frío, pinturas viejas debidamente lijadas. Para uso profesional. | |
| Attrezzatura: pennello, rullo, airless Diluizione: Diluente Sintetico - max 5% (airless 10%) Resa (1 mano): 8-10 m ² /l - Per confezione (10 l): 100 m ² Colore: bianco e colorato | | Equipment: brush, roller, airless Dilution: Diluente Sintetico - max 5% (airless 10%) Coverage (1 coat): 8-10 m ² /l - Per packaging (10 l): 100 m ² Color: white and colored | | Herramientas: brocha, rodillo, pistola pulverizadora Dilución: Diluente Sintetico - max 5% (pistola pulverizadora 10%) Rendimiento (1 capa): 8-10 m ² /l - Por envase (10 l): 100 m ² Color: blanco y colorido | |

| | | | |
|---|-----------------------|--------------------|-------------------|
| tecniche | certificazioni | proprietà | tecnologie |
| SOLVENT BASED BRUSH ROLLER AIRLESS | | matt BRILLIANCE | |

minio oleofenolico



scheda
tecnica



data
sheet



ficha
técnica



| | | | | | |
|---|----------------|---|----------------|---|-----------------|
| fondo antiruggine oleofenolico | esterno | oleophenolic rustproofing base coat | outdoor | fondo antióxido oleofenólico | exterior |
| Fondo antiruggine a base di resine oleofenoliche e cariche che conferiscono ottime caratteristiche antiruggine. Per esterno. Per uso professionale. | | Rust proofing base coat with oleophenolic resins and fillers to provide excellent rust proofing properties. For professional use. | | Fondo antióxido a base de resinas oleofenólicas y cargas que proporcionan excelentes características antióxido. Para uso profesional. | |
| Attrezzatura: pennello, rullo, airless Diluizione: Diluente Sintetico - max 5% Resa (1 mano): 8-10 m ² /l - Per confezione (2,5 l): 25 m ² Colore: arancio | | Equipment: brush, roller, airless Dilution: Diluente Sintetico - max 5% Coverage (1 coat): 8-10 m ² /l - Per packaging (2,5 l): 25 m ² Color: orange | | Herramientas: brocha, rodillo, pistola pulverizadora Dilución: Diluente Sintetico - max 5% Rendimiento (1 capa): 8-10 m ² /l - Por envase (2,5 l): 25 m ² Color: naranja | |

| | | | |
|---|-----------------------|--------------------|-------------------|
| tecniche | certificazioni | proprietà | tecnologie |
| SOLVENT BASED BRUSH ROLLER AIRLESS | | matt BRILLIANCE | |

Gratiff

protett

prodotti

silcal

silcal w

silacril

antigraffiti w

acrilux

algasol

graffiti

silcal



scheda
tecnica



data
sheet



ficha
técnica



| | | | | | |
|--|----------------|---|----------------|--|-----------------|
| protettivo silossanico non filmogeno | esterno | non film-forming, siloxane-based pro- tective coating | outdoor | protector siloxánico no filmógeno | exterior |
| <p>Protettivo trasparente a base di polisilossani oligomeri sciolti in solvente, formulata per dare al supporto idrorepellenza superficiale e in profondità, possiede un elevato potere penetrante e traspirante e polimerizza in profondità. Non è filmogeno, non modifica assolutamente l'estetica del manufatto. Per uso professionale.</p> | | <p>Transparent protective coating based on polysiloxane oligomers dissolved in solvent, formulated to make the substrate water repellent both on the surface and in depth. It has high penetrating power, is breathable and polymerizes in depth. It is non film-forming and does not alter the appearance of the product treated at all. For professional use.</p> | | <p>Protector transparente a base de polisiloxanos oligómeros disueltos en disolvente, formulado para dar al soporte propiedades hidro-repelentes en superficie y en profundidad, posee un alto poder penetrante y traspirante y polimeriza en profundidad. No es filmógeno, no modifica lo más mínimo la estética de las manufacturas. Para uso profesional.</p> | |
| <p>Attrezzatura: pennello, rullo, airless Diluizione: pronto all'uso Resa (1 mano): 8-10 m²/l - Per confezione (25 l): 250 m² Colore: incolore</p> | | <p>Equipment: brush, roller, airless Dilution: ready to use Coverage (1 coat): 8-10 m²/l - Per packaging (25 l): 250 m² Color: colourless</p> | | <p>Herramientas: brocha, rodillo, pistola pulverizadora Dilución: listo para usar Rendimiento (1 capa): 8-10 m²/l - Por envase (25 l): 250 m² Color: incoloro</p> | |

| tecniche | certificazioni | proprietà | tecnologie |
|---|----------------|-----------|------------|
| SOLVENT BASED BRUSH ROLLER AIRLESS READY TO USE | | | |

silcal w



scheda
tecnica



data
sheet



ficha
técnica



| | | | | | |
|---|----------------------------|---|---------------------------|--|------------------------------|
| resina monocomponente a iniezione | interno esterno | one-pack injection resin | indoor outdoor | resina monocomponente de inyección | interior exterior |
| <p>Microemulsione a base di silani e silossani monocomponente a base acqua pronto uso, contro la risalita capillare di umidità nelle muraure. Reagisce con l'umidità del supporto formando una pellicola idrorepellente che intasando le porosità ne impedisce l'assorbimento eliminando così la risalita dell'acqua dal terreno o dalle fondamenta. Per uso professionale.</p> | | <p>One-pack, ready-to-use, water-based micro-emulsion with silanes and siloxanes to treat capillary rising damp in masonry. Reacts with the damp in the substrate, forming a highly waterproof film that plugs the pores, thus preventing any absorption and rising of water from the foundations or underlying ground. For professional use.</p> | | <p>Microemulsión a base de silanos y siloxanos, monocomponente con base de agua listo para usar, contra la expansión capilar de la humedad en las paredes. Reacciona con la humedad del soporte formando una película hidro-repelente que, obturando las porosidades, impide la absorción y elimina completamente la subida del agua desde el terreno o desde los cimientos. Para uso profesional.</p> | |
| <p>Attrezzatura: Pompa volumetrica a bassa pressione Diluizione: pronto all'uso Resa: in funzione dell'assorbimento della muratura, indicativamente 7 l/m² per muratura da 40 cm Colore: incolore</p> | | <p>Equipment: Low pressure volumetric pump Dilution: ready to use Coverage: as a function of the absorption of the masonry, approximately 7 l/m² for 40 cm masonry Color: colourless</p> | | <p>Herramientas: Bomba volumétrica de baja presión Dilución: listo para usar Rendimiento: Según la absorción de la mampostería. Aproximadamente 7 litros / m para mampostería de 40 cm Color: incoloro</p> | |

| tecniche | certificazioni | proprietà | tecnologie |
|---|----------------|-----------|------------|
| WATER BASED BRUSH ROLLER AIRLESS READY TO USE | | | |

silacril



scheda
tecnica



data
sheet



ficha
técnica



| protettivo silossanico filmogeno | esterno | film-forming siloxane protective coating | outdoor | protector siloxánico filmógeno | exterior |
|---|---------|--|---------|--|----------|
| <p>Protettivo trasparente filmogeno, traspirante, al solvente a base di resine acriliche modificate con polisilossani oligomeri. Formulata per dare al supporto notevole idrorepellenza, anche in profondità, contemporaneamente ad una discreta azione barriera alla penetrazione dei gas a reazione acida contenuti nell'atmosfera. Ha un effetto perlante durevole nel tempo. Per uso professionale.</p> | | <p>Breathable, film-forming, transparent protective coating made with acrylic resin-based solvent modified with oligomer polysiloxanes. Formulated to make the substrate extremely water repellent, even in-depth, while offering, at the same time, a fair barrier against the penetration of acid reaction gases contained in the atmosphere. Long-lasting pearl-finish effect. For outdoor use. For professional use.</p> | | <p>Protector transparente filmógeno, transpirante, con disolvente a base de resinas acrílicas modificadas con polisiloxanos oligómeros. Formulado para dar al soporte una notable capacidad hidro-repelente, incluso en profundidad, y al mismo tiempo una discreta acción de barrera contra la penetración de los gases de reacción ácida contenidos en la atmósfera. Tiene un efecto perlado duradero. Para uso profesional.</p> | |
| <p>Attrezzatura: pennello, rullo, airless Diluizione: pronto all'uso Resa (1 mano): 8-10 m²/l - Per confezione (25 l): 250 m² Colore: incolore</p> | | <p>Equipment: brush, roller, airless Dilution: ready to use Coverage (1 coat): 8-10 m²/l - Per packaging (25 l): 250 m² Color: colourless</p> | | <p>Herramientas: brocha, rodillo, pistola pulverizadora Dilución: listo para usar Rendimiento (1 capa): 8-10 m²/l - Por envase (25 l): 250 m² Color: incoloro</p> | |

| tecniche | certificazioni | proprietà | tecnologie |
|---|----------------|------------|------------|
| SOLVENT BASED BRUSH ROLLER AIRLESS READY TO USE | | BREATHABLE | |

antigraffiti w



scheda
tecnica



data
sheet



ficha
técnica



| vernice all'acqua antigraffiti trasparente | esterno | transparent, anti-graffiti varnish | outdoor | pintura al agua antigraffiti transparente | exterior |
|--|---------|--|---------|--|----------|
| <p>Vernice bicomponente appositamente formulata per rendere estremamente difficile qualsiasi tipo di scritta o graffito sui supporti precedentemente trattati. A base di resina poliesteri ossidrilata ed addotti isocianici con additivi polisilossanici. Non ingiallente, ottima resistenza agli aggressivi chimici. Eccellente aderenza su supporti difficili. Per uso professionale.</p> | | <p>Two-pack varnish specially formulated to make it extremely difficult to write or draw any form of graffiti on the treated substrates. Based on hydroxylated polyester resin and isocyanate adducts with polysiloxane additives. Non-yellowing, highly resistant to chemicals. Excellent adhesion on difficult substrates. For professional use.</p> | | <p>Barniz bicomponente expresamente formulado para hacer extremadamente difícil cualquier tipo de pintada o grafiti sobre los soportes previamente tratados. A base de resina poliéster oxidrilada y aductos isocianicos con aditivos polisiloxánicos. No amarillea, excelente resistencia a los agentes químicos agresivos. Excelente adherencia en soportes difíciles. Para uso profesional.</p> | |
| <p>Attrezzatura: pennello, rullo, airless Diluizione: pronto all'uso Resa (2 mani): 5-7 m²/l - Per confezione (3 l + 0,24 l): 15 m² Colore: incolore</p> | | <p>Equipment: brush, roller, airless Dilution: ready to use Coverage (2 coats): 5-7 m²/l - Per packaging (3 l + 0,24 l): 15 m² Color: colourless</p> | | <p>Herramientas: brocha, rodillo, pistola pulverizadora Dilución: listo para usar Rendimiento (2 capas): 5-7 m²/l - Por envase (3 l + 0,24 l): 15 m² Color: incoloro</p> | |

| tecniche | certificazioni | proprietà | tecnologie |
|---|----------------|-----------|--------------|
| WATER BASED BRUSH ROLLER AIRLESS READY TO USE | | | RESISTANCE 4 |

acrilux



scheda
tecnica



data
sheet



ficha
técnica



| | | | | | |
|---|----------------|--|----------------|---|-----------------|
| protettivo trasparente lucido per rivestimenti e pitture | esterno | glossy transparent protective product for coatings and paints | outdoor | protector trasparente brillante para revestimientos y pinturas | exterior |
| Protettivo trasparente a base di particolari resine emulsionate in veicolo acquoso, da applicare come strato di finitura trasparente. Conferisce basso assorbimento e aspetto lucido. Idoneo come protettivo per Rivestimenti colorati e Paint HT. Per uso professionale. | | Transparent protective product with special resins in a water-based emulsion, to be applied as a transparent topcoat. Provides low absorption and glossy appearance. Suitable as protective product for coloured coatings and Paint HT. For outdoor use. For professional use. | | Protector transparente a base de resinas especiales emulsionadas en vehículo acuoso, para su aplicación como capa de acabado transparente. Proporciona baja absorción y aspecto brillante. Idóneo como protector para revestimientos de color y Paint HT. Para uso profesional. | |
| Attrezzatura: pennello, rullo Diluizione: pronto all'uso Resa (1 mano): come lucidante 8-10 m ² /l - Per confezione (25 l): 250 m ² Colore: incolore | | Equipment: brush, roller Dilution: ready to use Coverage (1 coat): as a polishing 8-10 m ² /l - Per packaging (25 l): 250 m ² Color: colourless | | Herramientas: brocha, rodillo Dilución: listo para usar Rendimiento (1 capa): 8-10 m ² /l - Por envase (25 l): 250 m ² Color: incoloro | |

| | | | |
|--|-----------------------|---------------------|-------------------|
| tecniche | certificazioni | proprietà | tecnologie |
| WATER BASED BRUSH ROLLER READY TO USE | | gloss BRILLIANCE | resistance 3 |

algasol



scheda
tecnica



data
sheet



ficha
técnica



| | | | | | |
|--|----------------|--|----------------|---|-----------------|
| soluzione battericida | esterno | bactericidal solution | outdoor | solución bactericida | exterior |
| Soluzione battericida da aggiungere a Paint HT e rivestimenti plastici continui, specifica per prevenire la proliferazione e conseguente annerimento dovuto alla presenza di alghe e muffe in ambienti esterni. Per uso professionale. | | Bactericidal solution to be added to Paint HT and continuous plastic coatings, specifically designed to prevent the proliferation of algae, mould and mildew, and the blackening they produce in outdoor environments. For outdoor use. For professional use. | | Solución bactericida para añadir a Paint HT y revestimientos plásticos continuos, específica para prevenir la proliferación y el consiguiente ennegrecimiento debido a la presencia de algas y mohos en ambientes externos. Para uso profesional. | |
| Modalità di utilizzo: aggiungere il prodotto in ragione di 1 l ogni 14 l di idropittura a pennello (0,500 l ogni 25 kg di Rivestimenti Plastici Continui). La diluizione dei prodotti deve tenere conto della quantità di Algasol già aggiunta Colore: incolore | | How to use: Add Algasol in the following doses: - 1 litre for every 14 litres of water-based paint for brush applications (0.5 litres for every 25 kg of continuous plastic coating). Product dilution must take into account the quantity of Algasol already added Color: colourless | | Como se usa: 1 litro cada 14 litros de pintura al agua en brocha 0,5 litros cada 25 kg de revestimientos plásticos continuos. color: incolore | |





**prodotti
speciali**

prodotti

capsulit

amianfix

muralpac liscio

bitum flex

detergente ac

grafinet

stonet

zincobrill

spartitraffico

sverniciatore n11

bio past

catalizzatore z8

armatex micro

ti
li

capsulit

scheda
tecnicadata
sheetficha
técnica

| pittura per incapsulamento amianto certificata | esterno | certified paint for asbestos encapsulation | outdoor | pintura certificada para encapsular amianto | exterior |
|---|---------|---|---------|--|----------|
| Pittura impermeabilizzante a base di resine acriliche, dotata di un'alta resistenza allo sporco, appositamente formulata per l'incapsulamento delle lastre di cemento amianto. Non permette il passaggio e la dispersione nell'atmosfera delle particelle di amianto contenute nel supporto. Per uso professionale. | | Acrylic resin-based waterproofing paint with high resistance to dirt. Specially formulated to encapsulate asbestos cement sheets. Prevents the particles of asbestos contained in the substrate from being dispersed in the atmosphere. For professional use. | | Pintura impermeabilizante a base de resinas acrílicas, dotada de alta resistencia a la suciedad, expresamente formulada para el encapsulado de las placas de amianto cemento. No permite el paso ni la dispersión en la atmósfera de las partículas de amianto contenidas en el soporte. Para uso profesional. | |
| Attrezzatura: pennello, rullo, airless Diluizione: acqua - max 5% Resa (3 mani): 1,6 m ² /l - Per confezione (14 l): 22,4 m ² Colore: bianco e colorato | | Equipment: brush, roller, airless Dilution: water - max 5% Coverage (3 coats): 1,6 m ² /l - Per packaging (14 l): 22,4 m ² Color: white and colored | | Herramientas: brocha, rodillo, pistola pulverizadora Dilución: agua - max 5% Rendimiento (3 mani): 1,6 m ² /l - Por envase (14 l): 22,4 m ² Color: blanco y colorido | |

| tecniche | certificazioni | proprietà | tecnologie |
|--|---|---|--|
|  WATER BASED  BRUSH  ROLLER  AIRLESS |  incapsula amianto |  V3 BREATHABLE |  resistance 5 |

amianfix

scheda
tecnicadata
sheetficha
técnica

| fissativo per incapsulamento amianto | esterno | fixative for asbestos encapsulation | outdoor | fijador para encapsulado de amianto | exterior |
|--|---------|---|---------|---|----------|
| Fissativo acrilico impregnante a base d'acqua, formulato per l'inertizzazione di materiali contenenti fibre d'amianto, al fine di procedere alla loro successiva rimozione. Conforme al decreto del Ministero della Sanità del 20 Agosto 1999 per rivestimenti incapsulanti tipo D. Per uso professionale. | | Water-based acrylic impregnating fixative, formulated for materials containing asbestos fibres, to render them inert so that they can be removed. Compliant with the decree issued by the Italian Ministry of Health on 20 August 1999 governing type D encapsulating coatings. For professional use. | | Fijador acrilico impregnante a base de agua, formulado para la inertización de materiales que contengan fibras de amianto, a fin de proceder a su posterior retirada. Conforme al decreto del Ministerio de Sanidad Italiano de 20 de agosto de 1999 para revestimientos encapsulantes de tipo D. Para uso profesional. | |
| Attrezzatura: pennello, airless Diluizione: acqua - 100% Resa (1 mano): 8 m ² /l - Per confezione (25 l): 200 m ² Colore: rosso ossido | | Equipment: brush, airless Dilution: water - 100% Coverage (1 coat): 8 m ² /l - Per packaging (25 l): 200 m ² Color: oxide red | | Herramientas: brocha, pistola pulverizadora Dilución: agua - 100% Rendimiento (1 capa): 8 m ² /l - Por envase (25 l): 200 m ² Color: rojo óxido | |

| tecniche | certificazioni | proprietà | tecnologie |
|--|----------------|-----------|------------|
|  WATER BASED  BRUSH  AIRLESS | | | |

muralpac liscio



scheda
tecnica



data
sheet



ficha
técnica



| pittura a base di Pliolite® | esterno | Pliolite® based paint | outdoor | pintura a base de Pliolite® | exterior |
|--|---------|--|---------|---|----------|
| <p>Pittura a base di Pliolite formulata con resine sintetiche insaponificabili, riempitivi naturali e pigmenti selezionati resistenti alla luce ed alle più gravose condizioni atmosferiche. Autopulente ed impermeabile con formulazione bilanciata per essere insensibile all'acqua pur permettendo la perfetta traspirazione del supporto. Particolarmente indicato per la protezione del calcestruzzo, anche se ammalorato. Per uso professionale.</p> | | <p>Pliolite® based paint paint based on unsaponifiable synthetic resins, natural fillers and selected pigments resistant to light and the most severe weather conditions. Self-cleaning and waterproof, formulated to be unaffected by water while still allowing the substrate to breathe perfectly. Particularly suited to protect concrete, even if deteriorated. For professional use.</p> | | <p>Formulada con resinas sintéticas insaponificables, rellenos naturales y pigmentos seleccionados resistentes a la luz y a las condiciones atmosféricas más exigentes. Autolimpiadora e impermeable, formulación equilibrada para ser insensible al agua si bien permite la perfecta transpiración del soporte. Particolarmente indicada para la protección del hormigón, incluso si está deteriorado. Para uso profesional.</p> | |
| <p>Attrezzatura: pennello, rullo, airless Diluizione: Diluente Sintetico - 8-10% Resa (2 mani): 4-5 m²/l - Per confezione (16 l): 80 m² Colore: bianco e colorato</p> | | <p>Equipment: brush, roller, airless Dilution: Diluente Sintetico - 8-10% Coverage (2 coats): 4-5 m²/l - Per packaging (16 l): 80 m² Color: white and colored</p> | | <p>Herramientas: brocha, rodillo, pistola pulverizadora Dilución: Diluente Sintetico - 8-10% Rendimiento (2 capas): 4-5 m²/l - Por envase (16 l): 80 m² Color: blanco y colorido</p> | |

| tecniche | certificazioni | proprietà | tecnologie |
|---|----------------|---------------|--------------|
| SOLVENT BASED BRUSH ROLLER AIRLESS | | V3 BREATHABLE | resistance 4 |

bitum flex



scheda
tecnica



data
sheet



ficha
técnica



| protettivo antiruggine bituminoso | esterno | bituminous rust proofing protective coating | outdoor | protector antióxido bituminoso | exterior |
|---|---------|---|---------|--|----------|
| <p>Protettivo antiruggine bituminoso per carpenterie metalliche, a base di catrame, specificamente formulato per la protezione di strutture, tubazioni, pluviali in metallo e lamiera zincata. Per uso professionale.</p> | | <p>Bitumen-based rustproofing protective coating for structural steel. Specially formulated to protect metal and galvanised sheet structures, piping and downpipes. For professional use.</p> | | <p>Protector antióxido bituminoso para carpenterías metálicas, con base de alquitrán, específicamente formulado para la protección de estructuras, tuberías, tubos para bajada de aguas pluviales en metal y chapa galvanizada. Para uso profesional.</p> | |
| <p>Attrezzatura: pennello, rullo, airless Diluizione: Diluente Nitro Antinebbia - pennello, rullo 2%, airless 5-7% Resa (1 mano): 8-9 m²/l - Per confezione (16 l): 120 m² Colore: nero</p> | | <p>Equipment: brush, roller, airless Dilution: Diluente Nitro Antinebbia - brush, roller 2%, airless 5-7% Coverage (1 coat): 8-9 m²/l - Per packaging (16 l): 120 m² Color: black</p> | | <p>Herramientas: brocha, rodillo, pistola pulverizadora Dilución: Diluente Nitro Antinebbia - brocha, rodillo 2%, pistola pulverizadora 5-7% Rendimiento (1 capa): 8-9 m²/l - Por envase (16 l): 120 m² Color: negro</p> | |

| tecniche | certificazioni | proprietà | tecnologie |
|---|----------------|------------------|--------------|
| SOLVENT BASED BRUSH ROLLER AIRLESS | | satin BRILLIANCE | resistance 3 |

detergente ac

scheda
tecnicadata
sheetficha
técnica

| detergente acido per prodotti lapidei | interno esterno | acid detergent for stone products | indoor outdoor | detergente ácido para productos de piedra | interior exterior |
|--|------------------------|--|-----------------------|--|--------------------------|
| Detergente acido per la pulizia e rimozione efflorescenze dovute alla risalita di Sali solubili sulla superficie di fughe e piastrelle oltre alla rimozione di formazioni calcaree. Per uso professionale. | | Acid detergent for the cleaning and removal of efflorescence due to the rise of soluble salts on the surface of joints and tiles as well as for the removal of scale. For professional use. | | Detergente ácido para la limpieza y eliminación de eflorescencias debidas a la expansión de las sales solubles sobre la superficie de las juntas y de las baldosas, así como para la eliminación de formaciones calcáreas. Para uso profesional. | |
| Attrezzatura: pennello, rullo, airless Diluizione: pronto all'uso Resa (2 mani): 6-8 m ² /l - Per confezione (25 l): 150-200 m ² Colore: incolore | | Equipment: brush, roller, airless Dilution: ready to use Coverage (2 coats): 6-8 m ² /l - Per packaging (25 l): 150-200 m ² Color: colourless | | Herramientas: brocha, rodillo, pistola pulverizadora Dilución: listo para usar Rendimiento (2 capas): 6-8 m ² /l - Por envase (25 l): 150-200 m ² Color: incoloro | |

| tecniche | certificazioni | proprietà | tecnologie |
|---|----------------|-----------|------------|
|  BRUSH  ROLLER  AIRLESS  READY TO USE | | | |

grafinet

scheda
tecnicadata
sheetficha
técnica

| detergente per rimozione di graffiti | esterno | detergent to remove graffiti | outdoor | detergente para eliminar grafitis | exterior |
|--|----------------|--|----------------|---|-----------------|
| Liquido viscoso da utilizzare per la rimozione di graffiti originati da spray. Per uso professionale | | Viscous liquid detergent to remove spray-painted graffiti. For professional use | | Líquido viscoso a utilizar para eliminar los grafitis hechos con espray. Para uso profesional. | |
| Attrezzatura: pennello Diluizione: pronto all'uso Resa (1 mano): 4-5 m ² /l - Per confezione (5 l): 25 m ² Colore: incolore | | Equipment: brush Dilution: ready to use Coverage (1 coat): 4-5 m ² /l - Per packaging (5 l): 25 m ² Color: colourless | | Herramientas: brocha Dilución: listo para usar Rendimiento (1 capa): 4-5 m ² /l - Por envase (5 l): 25 m ² Color: incoloro | |

| tecniche | certificazioni | proprietà | tecnologie |
|--|----------------|-----------|------------|
|  BRUSH  READY TO USE | | | |

stonet

scheda
tecnicadata
sheetficha
técnica

| detergente lapideo | esterno | stone detergent | outdoor | detergente para piedra | exterior |
|---|----------------|--|----------------|--|-----------------|
| Detergente liquido viscoso idoneo per supporti quali pietre, mattoni, gres, clinker, graniti e materiali lapidei. Il prodotto, se adeguatamente usato, non intacca i supporti trattati. Per uso professionale | | Viscous liquid detergent suitable for substrates such as stone, brick, porcelain stoneware, clinker, granite and stone materials. If properly used, the product does not affect the treated substrates. For professional use | | Detergente líquido viscoso adecuado para soportes como piedra, ladrillo, gres, clinker, granito y materiales lapídeos. El producto, si se usa correctamente, no marca los soportes tratados. Para uso profesional. | |
| Attrezzatura: pennello Diluizione: pronto all'uso Resa (1 mano): 4-5 m ² /l - Per confezione (25 l): 125 m ² Colore: incolore | | Equipment: brush Dilution: ready to use Coverage (1 coat): 4-5 m ² /l - Per packaging (25 l): 125 m ² Color: colourless | | Herramientas: brocha Dilución: listo para usar Rendimiento (1 capa): 4-5 m ² /l - Por envase (25 l): 125 m ² Color: incoloro | |

| tecniche | certificazioni | proprietà | tecnologie |
|---|----------------|-----------|------------|
|  WATER BASED  BRUSH  READY TO USE | | | |

zincobrill



scheda
tecnica



data
sheet



ficha
técnica



| | | | | | |
|---|----------------|---|----------------|---|-----------------|
| pittura per coperture bituminose e manufatti metallici | esterno | paint for bituminous coverings and metal items | outdoor | pintura para cubiertas bituminosas y elementos metálicos | exterior |
| Pittura sintetica a base alchidica con modificanti in unione a pasta di alluminio, buon potere coprente, resistente al calore, alto potere riflettente e buone proprietà protettive contro la ruggine. Per uso professionale. | | Alkyd-based, highly reflective, synthetic paint with modifiers in combination with aluminium paste. Provides good coverage, heat resistance and protects against rust. For professional use. | | Pintura sintética con base alquídica con modificantes y pasta de aluminio, con buena capacidad cubriente, resistente al calor, alto poder reflectante y buenas propiedades protectoras contra el óxido. Para uso profesional. | |
| Attrezzatura: pennello, rullo, airless Diluizione: pronto all'uso Resa (2 mani): 6,5-7 m ² /l - Per confezione (16 l): 112 m ² Colore: alluminio | | Equipment: brush, roller, airless Dilution: ready to use Coverage (2 coats): 6,5-7 m ² /l - Per packaging (16 l): 112 m ² Color: aluminium | | Herramientas: brocha, rodillo, pistola pulverizadora Dilución: listo para usar Rendimiento (2 capas): 6,5-7 m ² /l - Por envase (16 l): 112 m ² Color: aluminio | |

| tecniche | | | | | certificazioni | | | | proprietà | | | | tecnologie | | | |
|---------------|-------|--------|---------|--------------|----------------|--|--|--|-----------|--|--|--|------------|--|--|--|
| | | | | | | | | | | | | | | | | |
| SOLVENT BASED | BRUSH | ROLLER | AIRLESS | READY TO USE | | | | | | | | | | | | |

spartitraffico



scheda
tecnica



data
sheet



ficha
técnica



| | | | | | |
|--|----------------|---|----------------|---|-----------------|
| pittura per segnaletica stradale | esterno | paint for road marking | outdoor | pintura para demarcación vial | exterior |
| Pittura al solvente a base di resine gliceroftaliche modificate e clorocaucciù, altamente resistente ed aderente, appositamente formulata per segnaletica stradale. Essiccazione rapida. Prodotto anche nella versione rifrangente secondo Capitolato ANAS. Per uso professionale. | | Solvent-based paint containing modified glycerophthalic resins and chlorinated rubber, highly resistant and adhesive. Specially formulated for road marking. Fast drying. Also available in reflecting version as per ANAS Specifications. For outdoor use. For professional use. | | Pintura al disolvente con base de resinas gliceroftálicas modificadas y clorocaucho, altamente resistente y adherente, expresamente formulada para demarcación vial. Secado rápido. Producida también en la versión reflectante conforme a las Especificaciones ANAS. Para uso profesional. | |
| Attrezzatura: traccialinee stradali, pennello, rullo, airless Diluizione: Diluente per Spartitraffico - 10-15% Resa (1 mano): 12,5-25 m - Per confezione (16 l): 200-400 m Colore: bianco, giallo, blu e rifrangente | | Equipment: road marking, brush, roller, airless Dilution: Diluente per Spartitraffico - 10-15% Coverage (1 coat): 12,5-25 m - Per packaging (16 l): 200-400 m Color: white, yellow, blue and reflective | | Herramientas: traccialinee stradali, brocha, rodillo, pistola pulverizadora Dilución: Diluente per Spartitraffico - 10-15% Rendimiento (1 capa): 12,5-25 m - Por envase (16 l): 200-400 m Color: blanco, amarillo, azul y reflectante | |

| tecniche | | | | | certificazioni | | | | proprietà | | | | tecnologie | | | | |
|---------------|-------|--------|---------|--|----------------|--|--|--|-----------|--|--|--|------------|--|--|--|--|
| | | | | | | | | | | | | | | | | | |
| SOLVENT BASED | BRUSH | ROLLER | AIRLESS | | | | | | WALKABLE | | | | | | | | |

sverniciatore n11

scheda
tecnicadata
sheetficha
técnica

| prodotto decapante | interno esterno | pickling product | indoor outdoor | producto decapante | interior exterior |
|---|--------------------|---|-------------------|--|----------------------|
| Prodotto decapante esente da cloruro di metilene, studiato per asportare qualsiasi tipo di pittura, vernice o rivestimento già essiccato indipendentemente dalla sua anzianità o natura. Per uso professionale. | | Pickling product free from methylene chloride, designed to remove any type of paint, varnish or coating that has already dried regardless of its age or nature. For professional use. | | Producto decapado libre de cloruro de metileno, diseñado para eliminar cualquier tipo de pintura, barniz o revestimiento que ya se haya secado independientemente de su edad o naturaleza. Para uso profesional. | |
| Attrezzatura: pennello Diluizione: pronto all'uso Resa: (1 mano): 2-3 m ² /l - Per confezione (20 l): 50 m ² Colore: alluminio | | Equipment: brush Dilution: ready to use Coverage (1 coat): 2-3 m ² /l - Per packaging (20 l): 50 m ² Color: aluminium | | Herramientas: brocha Dilución: listo para usar Rendimiento (1 capa): 2-3 m ² /l - Por envase (20 l): 50 m ² Color: aluminio | |

| tecniche | | | certificazioni | | | proprietà | | | tecnologie | | |
|----------|--|--|----------------|--|--|-----------|--|--|------------|--|--|
| | | | | | | | | | | | |

bio-past

scheda
tecnicadata
sheetficha
técnica

| additivo antimuffa | anti-mold additive | aditivo anti-moho |
|---|--|--|
| Additivo a base di prodotti insolubili in acqua, idoneo a rendere il film delle idropitture protetto dall'attacco di muffe e microrganismi. Non dà alterazioni nel colore né addensamenti. Per uso professionale. | Additive based on water-insoluble products, suitable for making the film of water-based paints protected from the attack of molds and microorganisms. It does not give alterations in color or thickening. For professional use. | Aditivo a base de productos insolubles en agua, apto para realizar la película de pinturas al agua protegidas del ataque de mohos y microorganismos. No da alteraciones de color ni engrosamiento. Para uso profesional. |
| Modalità di utilizzo: aggiungere la confezione di BIO-PAST (0,250 l) in 5 l di idropittura mescolando per almeno 2 minuti Colore: bianco | How to use: Add the package of BIOPAST (250 g) to 5 l of a water-based paint and stir for at least 2 minutes Color: white | Modo de empleo: añadir el paquete de BIOPAST (0,250 l) en 5 l de pintura al agua, mezclando durante al menos 2 minutos. color: blanco |

| tecniche | | | certificazioni | | | proprietà | | | tecnologie | | |
|----------|--|--|----------------|--|--|-----------|--|--|------------|--|--|
| | | | | | | | | | | | |

catalizzatore z8



scheda
tecnica



data
sheet



ficha
técnica



| catalizzatore poliuretanico | interno esterno | polyurethane catalyst | indoor outdoor | catalizador de poliuretano | interior exterior |
|---|-----------------|---|----------------|--|-------------------|
| Catalizzatore poliuretanico per prodotti sintetici ai quali si richiedano particolari resistenze all'abrasione, notevole durezza superficiale, maggiore rapidità di essiccazione, migliorandone la resistenza nel tempo. Idoneo per Marineria, Crystal e Crystal SX. Per uso professionale. | | Polyurethane catalyst for synthetic products which require particular resistance to abrasion, considerable surface hardness, faster drying, improving their resistance over time. Suitable for Marineria, Crystal, Crystal SL and Crystal SX. For professional use. | | Catalizador de poliuretano para productos sintéticos que requieran especial resistencia a la abrasión, considerable dureza superficial, secado más rápido, mejorando su resistencia con el tiempo. Adecuado para Marineria, Crystal, y Crystal SX. Para uso profesional. | |
| Diluizione: pronto all'uso Modalità di utilizzo: Marineria 8,5:1,5 (in volume). Miscelare fino ad omogeneizzazione. Diluire in seguito il prodotto secondo la rispettiva scheda tecnica Colore: incolore | | Dilution: ready to use How to use: Marineria 8,5:1,5. Mix the resulting mixture until smooth. Then dilute the product following the indications on the Technical Data Sheets Color: colourless | | Dilución: listo para usar Modo de uso: Marinería 8,5:1,5 (en volumen). Mezclar hasta homogeneización. Diluir posteriormente el producto según la respectiva ficha técnica Color: incoloro | |

| tecniche | certificazioni | proprietà | tecnologie |
|----------|----------------|-----------|------------|
| | | | |

armatex micro



scheda
tecnica



data
sheet



ficha
técnica



| rete in fibra di vetro | interno esterno | fiberglass net | indoor outdoor | malla de fibra de vidrio | interior exterior |
|---|-----------------|---|----------------|---|-------------------|
| Rete tessuta in fibra di vetro impiegata come armatura per cicli elastomerici. | | Woven glass fibre mesh used as reinforcement for elastomeric cycles. | | Malla tejida de fibra de vidrio utilizada como refuerzo para ciclos elastoméricos. | |
| Attrezzatura: coltello a lame intercambiabili (tipo Stanley), frattazzo metallico Grammatura: 70 g/m ² Resa: 1,10 m ² di rete per 1 m ² di supporto (comprese le necessarie sovrapposizioni). Misura: 1 x 50 m per totali 50 m ² | | Equipment: Knife with interchangeable blades (Stanley type), metal trowel Grammatura: 70 g/m ² Coverage: 1,10 m ² network for 1 m ² of support (including the necessary overlapping). Size: 1 x 50 m per tot. 50 m ² | | Herramientas: cuchillo de hoja intercambiable (tipo Stanley), llana de metal Grammatura: 70 g/m ² Rendimiento: 1,10 m ² de malla por 1 m ² de soporte (incluidas las superposiciones necesarias). Misura: 1 x 50 para totales 50 m ² | |

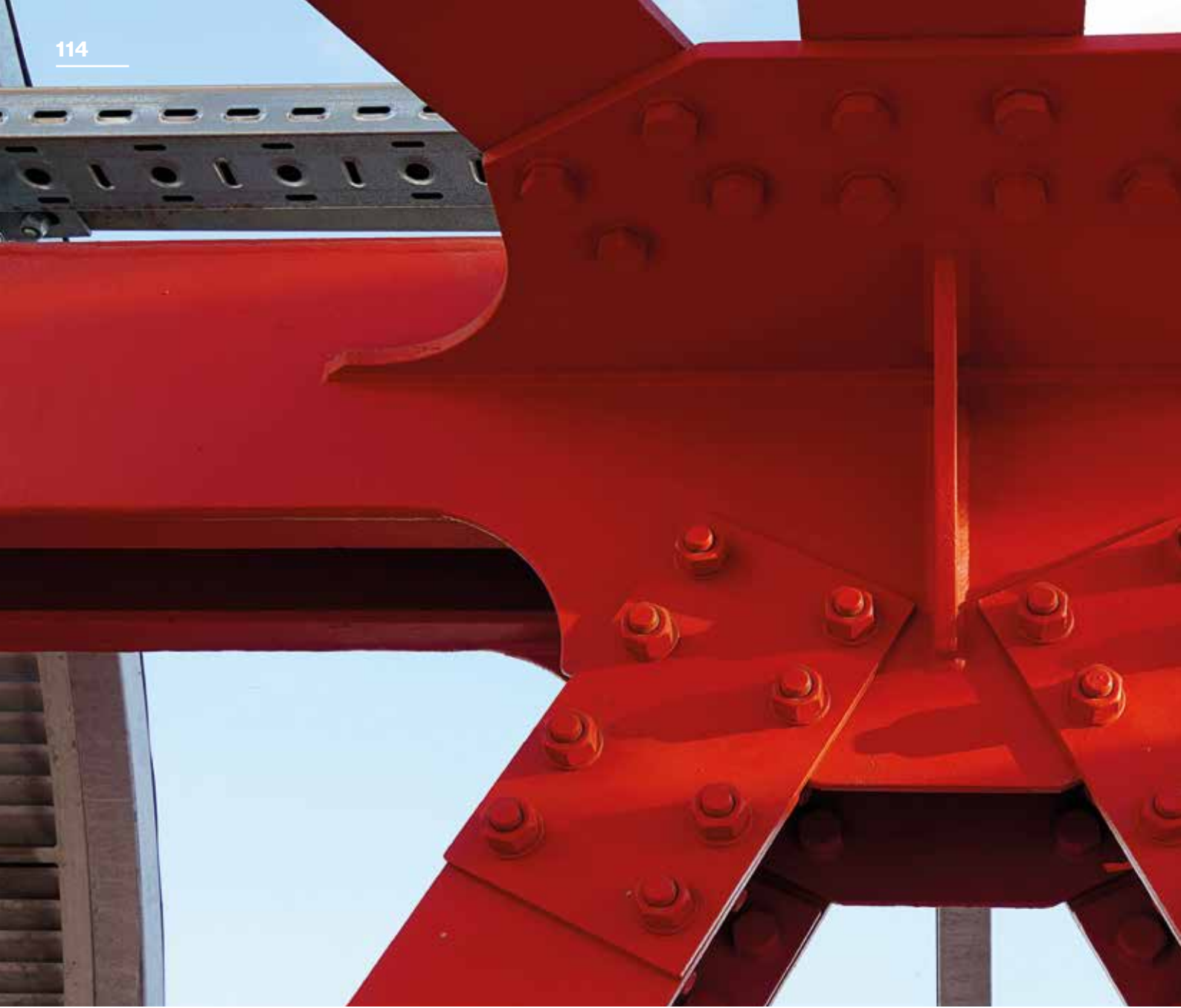

industri

prodotti

antiruggine per carrozzeria

epozinco

rapidex

clorex



ria

antiruggine per carrozzeria



scheda
tecnica



data
sheet



ficha
técnica



| fondo antiruggine alchidico | interno esterno | oleophenolic rust proofing base coat | indoor outdoor | fondo antióxido alquídico | interior exterior |
|--|------------------------|---|-----------------------|---|--------------------------|
| Fondo antiruggine alchidico a rapida essiccazione per verniciature industriali a base di resine alchiliche corto olio e modificazioni fenoliche, pigmento antiruggine di elevata qualità. Resistente alla sovraspruzzatura con nitro. Per uso professionale. | | Fast drying rustproofing alkyd base coat for industrial painting containing short oil alkyd resins with phenolic modifications and high quality rustproofing pigment. It can resist overspraying with nitro-based products. For professional use. | | Fondo antióxido alquídico de secado rápido para operaciones de pintado industrial a base de resinas alquídicas, de aceite corto y modificaciones fenólicas, pigmento antióxido de alta calidad. Resistente a recubrimiento nitro con pistola. Para uso profesional. | |
| Attrezzatura: pennello, rullo, airless Diluizione: Diluente Nitro Antinebbia - max 10% Resa (1 mano): 8-10 m ² /l - Per confezione (10 l): 100 m ² Colore: bianco e colorato | | Equipment: brush, roller, airless Dilution: Diluente Nitro Antinebbia - max 10% Coverage (1 coat): 8-10 m ² /l - Per packaging (10 l): 100 m ² Color: white and colored | | Herramientas: brocha, rodillo, pistola pulverizadora Dilución: Diluente Nitro Antinebbia - max 10% Rendimiento (1 capa): 8-10 m ² /l - Por envase (10 l): 100 m ² Color: blanco y colorido | |

| tecniche | certificazioni | proprietà | tecnologie |
|---|----------------|--------------------|------------|
| SOLVENT BASED BRUSH ROLLER AIRLESS | | matt BRILLIANCE | |

epozinco



scheda
tecnica



data
sheet



ficha
técnica



| fondo antiruggine epossidico | interno esterno | rust proofing epoxy base coat | indoor outdoor | fondo antióxido epoxídico | interior exterior |
|---|------------------------|---|-----------------------|---|--------------------------|
| Fondo antiruggine epossidico dotato di ottima aderenza su tutti i supporti metallici, ottima resistenza agli agenti chimici ed all'esposizione in atmosfera industriale e marina. Idoneo come primer su manufatti metallici in ferro lega leggera e lamiera zincata quali impianti industriali, parti di macchinari, tubazioni, palificazioni, soggetti ad aggressioni di particolare gravità. Per uso professionale. | | Rust proofing epoxy base coat providing excellent adhesion on all metal substrates, superb resistance to chemical agents and exposure to industrial and marine atmospheres. Ideal for use as primer on light steel and galvanised sheet items — such as industrial plants, machinery parts, piping and poles — subject to particularly aggressive environments. For professional use. | | Fondo antióxido epoxídico dotato de excelente adherencia en todos los soportes metálicos, excelente resistencia a los agentes químicos y a la exposición en atmósfera industrial y marina. Idóneo como imprimación sobre elementos metálicos en hierro, aleación ligera y chapa galvanizada, como equipos industriales, partes de maquinarias, tuberías, postes y pilotes, sujetos a agresiones particularmente graves. Para uso profesional. | |
| Attrezzatura: pennello, rullo, airless Rapporto di catalisi: (A:B) 4:0,64 in volume Diluizione: Diluente per Epossidici - rullo: 5-7%; airless: 7-15%; pennello 5-10% Resa (1 mano): 6-7 m ² /l - Per confezione (4 kg + 0,64 kg): 35 m ² Color: grigio | | Equipment: brush, roller, airless Ratio of catalysis: (A:B) 4:0,64 in volume Dilution: Diluente per Epossidici - roller: 5-7%; airless: 7-15%; brush 5-10% Coverage (1 coat): 6-7 m ² /l - Per packaging (4 kg + 0,64 kg): 35 m ² Color: gray | | Herramientas: brocha, rodillo, pistola pulverizadora Relación de mezcla: (A:B) 4:0,64 in volume Dilución: Diluente per Epossidici - rodillo 5-7%; pistola pulverizadora 7-15%; brocha 5-10% Rendimiento (1 capa): 6-7 m ² /l - Por envase (4 kg + 0,64 kg): 35 m ² Color: gris | |

| tecniche | certificazioni | proprietà | tecnologie |
|---|----------------|---------------------|--------------|
| SOLVENT BASED BRUSH ROLLER AIRLESS | | satin BRILLIANCE | resistance 3 |

rapidex



scheda
tecnica



data
sheet



ficha
técnica



| smalto sintetico alchidico | interno esterno | synthetic alkyd enamel | indoor outdoor | esmalte sintético alquídico | interior exterior |
|---|-----------------|--|----------------|--|-------------------|
| <p>Smalto sintetico industriale a rapida essiccazione a base di resine alchiliche, corto olio e pigmenti selezionati resistenti alla luce. Ottima resistenza all'acqua ed agli agenti atmosferici indicato per verniciature di veicoli industriali, macchine agricole e profilati di ferro esenti da ruggine, grasso e calamina. Per uso professionale.</p> | | <p>Fast-drying, synthetic industrial enamel based on short oil alkyd resins and selected light-resistant pigments. Superb resistance to water and the weather. Suitable for painting industrial vehicles, agricultural machinery and iron profiles that are free of rust, grease and mill scale. For professional use.</p> | | <p>Esmalte sintético industrial de secado rápido con base de resinas alquídicas, de aceite corto y pigmentos seleccionados resistentes a la luz. Excelente resistencia al agua y a los agentes atmosféricos, indicado para pintado de vehículos industriales, máquinas agrícolas y perfilados de hierro limpios de óxido, grasa y carbonillas. Para uso profesional.</p> | |
| <p>Attrezzatura: airless Diluizione: Diluente Nitro Antinebbia - 10% Resa (2 mani): 4-5 m²/l - Per confezione (10 l): 50 m² Colore: bianco e colorato</p> | | <p>Equipment: airless Dilution: Diluente Nitro Antinebbia - 10% Coverage (2 coats): 4-5 m²/l - Per packaging (10 l): 50 m² Color: white and colored</p> | | <p>Herramientas: pistola pulverizadora Dilución: Diluente Nitro Antinebbia - 10% Rendimiento (2 capas): 4-5 m²/l - Por envase (10 l): 50 m² Color: blanco y colorido</p> | |

| tecniche | certificazioni | proprietà | tecnologie |
|----------|----------------|-----------|------------|
| | | | |

clorex



scheda
tecnica



data
sheet



ficha
técnica



| smalto alchidico cloroacchiù | esterno | alkyd chlorinated rubber enamel | outdoor | esmalte alquídico de cloro Caucho | exterior |
|---|---------|---|---------|--|----------|
| <p>Smalto combinato a base di resine cloroacchiù e alchidiche, pigmenti resistenti agli agenti atmosferici. Indicato ove sia necessaria una forte resistenza alla corrosione atmosferica. Per uso professionale.</p> | | <p>Combination chlorinated rubber and alkyd resins-based enamel containing weather-resistant pigments. Suitable whenever high resistance to corrosive atmospheres is required. For professional use.</p> | | <p>Esmalte combinado a base de resinas de cloro Caucho y alquídicas, pigmentos resistentes a los agentes atmosféricos. Indicado allí donde se necesite una fuerte resistencia a la corrosión atmosférica. Para uso profesional.</p> | |
| <p>Attrezzatura: pennello, rullo, airless Diluizione: Diluente Nitro Antinebbia - 15% Resa (2 mani): 4-5 m²/kg - Per confezione (20 kg): 100 m² Colore: bianco e colorato</p> | | <p>Equipment: brush, roller, airless Dilution: Diluente Nitro Antinebbia - 15% Coverage (2 coats): 4-5 m²/kg - Per packaging (20 kg): 100 m² Color: white and colored</p> | | <p>Herramientas: brocha, rodillo, pistola pulverizadora Dilución: Diluente Nitro Antinebbia - 15% Rendimiento (2 capas): 4-5 m²/kg - Por envase (20 kg): 100 m² Color: blanco y colorido</p> | |

| tecniche | certificazioni | proprietà | tecnologie |
|----------|----------------|-----------|------------|
| | | | |



diluenti



sintetico

| | | |
|---|--|--|
| Diluyente sintético per la diluizione di smalti sintetici e oleosintetici. | Synthetic thinner to dilute synthetic and oleosynthetic enamels | Diluyente sintético para esmaltes sintéticos y oleosintéticos. |
| Per: Aderlac HQ, Cerato Opaco, Fondo per Legno, Marineria, Marineria Opaco, Micafer, Minio Oleofenolico, Muralpac Liscio, Rusty | For: Aderlac HQ, Cerato Opaco, undercoat for wood, Marineria, Marineria Opaco, Micafer, Minio Oleofenolico, Muralpac Liscio, Rusty | para: Aderlac HQ, Cerato Opaco, Fondo per Legno, Marineria, Marineria Opaco, Micafer, Minio Oleofenolico, Muralpac Liscio, Rusty |



nitro antinebbia

| | | |
|--|--|---|
| Miscela di solventi organici. Per la diluizione di tutti i prodotti a base nitro ed a rapida essiccazione. | Blend of organic solvents. Used to dilute all nitro-based and fast-drying products. | Mezcla de disolventes orgánicos. Para diluir todos los productos con base nitro y de secado rápido. |
| Per: Antiruggine per Carrozzeria, Bitum Flex, Cloro-Pool, Clorex, Nitrofix, Rapidex. | For: Antiruggine per Carrozzeria, Bitum Flex, Cloro-Pool, Clorex, Nitrofix, Rapidex. | para: Antiruggine per Carrozzeria, Bitum Flex, Cloro-Pool, Clorex, Nitrofix, Rapidex. |



per spartitraffico

| | | |
|--|---|--|
| Diluyente specifico per finiture spartitraffico. | Specific thinner for spartitraffico paint | Diluyente específico para acabados con spartitraffico. |
| Per: Spartitraffico | For: Spartitraffico | Para: Spartitraffico |



per epossidici

| | | |
|--|--|---|
| Diluyente specifico per finiture epossidiche. | Specific thinner for epoxy topcoats. | Diluyente específico para acabados epoxídicos. |
| Per: Epozinco, Epoxy Fondo, Epoxy Paint HT, Primer-Pool, Epoxy Fondo AS, Epoxy Fondo Oil, Polyelastic, Epoxy Paint LT. | For: Epozinco, Epoxy Undercoat, Epoxy Paint HT, Primer-Pool, Epoxy Undercoat AS, Epoxy Undercoat Oil, Polyelastic, Epoxy Paint LT. | para: Epozinco, Epoxy Fondo, Epoxy Paint HT, Primer-Pool, Epoxy Fondo AS, Epoxy Fondo Oil, Polyelastic, Epoxy Paint LT. |



per poliuretanic

| | | |
|--|---|---|
| Diluyente poliuretanic per la diluizione di fondi e finiture lucide e opache poliuretanic. | Polyurethane thinner to dilute gloss and matt polyurethane base coats and topcoats. | Diluyente poliuretánico para fondos y acabados poliuretánicos brillantes y mates. |
| Per: Betonglass, Ivaglass, Paviglass. | For: Betonglass, Ivaglass, Paviglass. | para: Betonglass, Ivaglass, Paviglass. |



linea pi

prodotti

primer-pool

inter-pool

cloro-pool

iscine

primer-pool



scheda
tecnica



data
sheet



ficha
técnica



| primer epossidico per piscine | esterno | epoxy primer for swimming pools | outdoor | imprimación epoxídica para piscinas | exterior |
|---|---------|---|---------|--|----------|
| <p>Primer epossidico bicomponente a solvente con ottima resistenza agli agenti atmosferici e chimici, idoneo per applicazioni in atmosfera industriale, piscine ed acqua di mare. Particolarmente indicato come mano di impregnazione e promotore di aderenza quando il manufatto debba essere finito con pitture epossidiche, epossiviniliche, poliuretatiche o clorocaucciù. Per uso professionale.</p> | | <p>Two-pack solvent-based epoxy primer with superb resistance to atmospheric and chemical agents, ideal for applications in industrial atmospheres, swimming pools and sea water. Particularly suitable as impregnation coat and adhesion promoter when the item is to be finished with epoxy, epoxyvinyl, polyurethane or chlorinated-rubber paints. For professional use.</p> | | <p>Imprimación epoxídica bicomponente con disolvente, de excelente resistencia a los agentes atmosféricos y químicos, idóneo para aplicaciones en atmósfera industrial, piscinas y agua de mar. Particolarmente indicada como mano de impregnación y promotor de adherencia cuando la superficie deba recibir un acabado con pinturas epoxídicas, epoxivinilicas, poliuretánicas o de clorocaucho. Para uso profesional.</p> | |
| <p>Attrezzatura: pennello, rullo Rapporto di catalisi: (A:B) 1:1 Diluizione: Diluente per Epossidici - max 5% Resa (1 mano): 5-7 m²/kg - Per confezione (4 kg + 4 kg): 56 m² Colore: incolore</p> | | <p>Equipment: brush, roller Ratio of catalysis: (A:B) 1:1 Dilution: Diluente per Epossidici - max 5% Coverage (1 coat): 5-7 m²/kg - Per packaging (4 kg + 4 kg): 56 m² Color: colourless</p> | | <p>Herramientas: brocha, rodillo Relación de mezcla: (A:B) 1:1 Dilución: Diluente per Epossidici - max 5% Rendimiento (1 capa): 5-7 m²/kg - Por envase (4 kg + 4 kg): 56 m² Color: incoloro</p> | |

| tecniche | certificazioni | proprietà | tecnologie |
|----------|----------------|-----------|------------|
| | | | |

inter-pool



scheda
tecnica



data
sheet



ficha
técnica



| intermedio epossidico per piscine | esterno | epoxy intermediate coating for swimming pools | outdoor | revestimiento epoxídico para piscinas | exterior |
|--|---------|---|---------|---|----------|
| <p>Rivestimento intermedio epossidico bicomponente a solvente, costituito con indurenti e riempitivi appropriati. Presenta elevata resistenza chimica e all'immersione in acqua dolce e salata. Idoneo anche per applicazioni verticali, in quanto ha sufficienti requisiti di resistenza alla colatura. Idoneo come mano intermedia per cicli anticorrosivi e cicli per piscine. Per uso professionale.</p> | | <p>Two-pack solvent-based epoxy intermediate coating consisting of appropriate curing agents and fillers. It offers high resistance to chemicals and immersion in fresh and salt water. Also ideal for vertical applications since it is quite resistant to dripping. Suitable as intermediate coat for anti-corrosion and swimming pool application processes. For professional use.</p> | | <p>Revestimiento intermedio epoxídico bicomponente con disolvente, constituido con endurecedores y rellenos adecuados. Presenta alta resistencia química y a la inmersión en agua dulce y salada. Idóneo también para aplicaciones verticales, dado que posee suficientes requisitos de resistencia a la formación de goterones. Idóneo como mano intermedia para ciclos anticorrosivos y ciclos para piscinas. Para uso profesional.</p> | |
| <p>Attrezzatura: rullo, frattazzo o staggia Rapporto di catalisi: (A:B) 1:1 Diluizione: pronto all'uso Resa (1 mano): 3-3,5 m²/kg - Per confezione (4 kg + 4 kg): 25 m² Colore: bianco e colorato</p> | | <p>Equipment: roller, trowel or stagger Ratio of catalysis: (A:B) 1:1 Dilution: ready to use Coverage (1 coat): 3-3,5 m²/kg - Per packaging (4 kg + 4 kg): 25 m² Color: white and colored</p> | | <p>Herramientas: rodillo de lana de pelo corto, lana o regla Relación de mezcla: (A:B) 1:1 Dilución: listo para usar Rendimiento (1 capa): 3-3,5 m²/kg - Por envase (4 kg + 4 kg): 25 m² Color: blanco y colorido</p> | |

| tecniche | certificazioni | proprietà | tecnologie |
|----------|----------------|-----------|------------|
| | | | |

cloro-pool



scheda
tecnica



data
sheet



ficha
técnica



| | | | | | |
|--|----------------|---|----------------|--|-----------------|
| smalto clorocaucciù per piscine | esterno | chlorinated rubber enamel for swimming pools | outdoor | esmalte de clorocaucho para piscinas | exterior |
| Smalto combinato a base di resine cloro- caucciù, pigmenti resistenti agli agenti atmo- sferici. Appositamente formulato per la pit- turazione di piscine. Per uso professionale. | | Combination chlorinated rubber resin-ba- sed enamel containing weather-resistant pigments. Specially formulated to paint swimming pools. For professional use. | | Esmalte combinado a base de resinas de clorocaucho, pigmentos resistentes a los agentes atmosféricos. Especificamente formulado para pintar piscinas. Para uso profesional. | |
| Attrezzatura: pennello, rullo, airless Diluizione: Diluente Nitro Antinebbia - 15% Resa (2 mani): 5-6 m ² /l - Per confezione (16 l): 96 m ² Colore: azzurro | | Equipment: brush, roller, airless Dilution: Diluente Nitro Antinebbia - 15% Coverage (2 coats): 5-6 m ² /l - Per packag- ing (16 l): 96 m ² Color: blue | | Herramientas: brocha, rodillo, pistola pulver- izadora Dilución: Diluyente Nitro Antinebbia - 15% Rendimiento (2 capas): 5-6 m ² /l - Por en- vase (16 l): 96 m ² Color: azul | |

| tecniche | | | | certificazioni | | | | proprietà | | | | tecnologie | | | | |
|------------------|-------|--------|---------|----------------|--|--|--|------------|--|--|--|------------|-----------------|--|--|--|
| | | | | | | | | | | | | | | | | |
| SOLVENT BASED | BRUSH | ROLLER | AIRLESS | | | | | BRILLIANCE | | | | | RESISTANCE 3 | | | |

ciclo al solvente per la verniciatura di vasche e piscine a basso spessore - solvent cycle for the painting of tanks and pools low thickness - ciclo a base de disolventes para pintar tanques y piscinas bajo espesor

| | |
|---|-------------------------------|
| consolidamento / imprimitura consolidation/ priming consolidación / imprimación | finitura finish acabado |
| primer-pool pag. 122 | cloro-pool pag. 123 |

ciclo al solvente per la verniciatura di vasche e piscine a alto spessore - solvent cycle for the painting of tanks and pools high thickness - ciclo a base de disolventes para pintar tanques y piscinas alto espesor

| | | |
|---|--|--|
| consolidamento / imprimitura consolidation/ priming consolidación / imprimación | strato uniformante uniforming layer capa uniformante | finitura finish acabado |
| primer-pool pag. 122 | inter-pool pag. 122 | cloro-pool pag. 123 oppure betonglass pag. 59 |



lineale

prodotti

marineria

marineria opaco

thinner fill

cerato

idroflatting

idroflatting opaco

idrofill

idrocerato

egno

marineria



scheda
tecnica



data
sheet



ficha
técnica



| finitura per legno | interno esterno | wood finish | indoor outdoor | acabado per legno | interior exterior |
|---|--------------------|---|-------------------|--|----------------------|
| <p>Vernice trasparente uretanizzata, di elevato pregio e brillantezza. Forma un film protettivo resistente agli agenti esterni e all'attacco di muffe. Garantisce la protezione dai raggi ultravioletti. Formulata per il trattamento di manufatti situati all'esterno in ambiente marino. Per uso professionale.</p> | | <p>Transparent, high quality urethanized varnish based on a blend of synthetic and urethane resins. It forms a protective film resistant to the weather and mould. To ensure protection against ultraviolet light. Formulated to treat items in wood located outdoors in marine environments. For professional use.</p> | | <p>Barniz transparente uretanizado de alta calidad y brillo. Forma una película protectora resistente a los agentes externos y a los mohos. Garantizar la protección del soporte contra los rayos ultravioleta. Formulado para el tratamiento de elementos de madera expuestos a la intemperie en ambiente marino. Para uso profesional.</p> | |
| <p>Attrezzatura: pennello, rullo Diluizione: Diluente Sintetico - 5% Resa (1 mano): 8 m²/l - Per confezione (15 l): 120 m² Colore: incolore</p> | | <p>Equipment: brush, roller Dilution: Diluente Sintetico - 5% Coverage (1 coat): 8 m²/l - Per packaging (15 l): 120 m² Color: colourless</p> | | <p>Herramientas: brocha, rodillo Dilución: Diluente Sintetico - 5% Rendimiento (1 capa): 8 m²/l - Por envase (15 l): 120 m² Color: incoloro</p> | |

| tecniche | certificazioni | proprietà | tecnologie |
|----------------------------------|----------------|------------|------------|
| SOLVENT BASED BRUSH ROLLER | | BRILLIANCE | |

marineria opaco



scheda
tecnica



data
sheet



ficha
técnica



| finitura per legno opaca | interno esterno | matt wood finish | indoor outdoor | acabado per legno opaca | interior exterior |
|--|--------------------|--|-------------------|--|----------------------|
| <p>Vernice trasparente uretanizzata, di elevato pregio. Forma un film protettivo resistente agli agenti esterni e all'attacco di muffe. Garantisce la protezione dai raggi ultravioletti. Formulata per il trattamento di manufatti situati all'esterno in ambiente marino. Per uso professionale.</p> | | <p>Transparent, high quality urethanized varnish. It forms a protective film resistant to the weather and mould. Ensure protection against ultraviolet light. Formulated to treat items in wood located outdoors in marine environments. For professional use.</p> | | <p>Barniz transparente uretanizado de alta calidad y brillo. Forma una película protectora resistente a los agentes externos y a los mohos. Garantizar la protección del soporte contra los rayos ultravioleta. Formulado para el tratamiento de elementos de madera expuestos a la intemperie en ambiente marino. Para uso profesional.</p> | |
| <p>Attrezzatura: pennello, rullo Diluizione: Diluente Sintetico - 5% Resa (1 mano): 8 m²/l - Per confezione (15 l): 120 m² Colore: incolore</p> | | <p>Equipment: brush, roller Dilution: Diluente Sintetico - 5% Coverage (1 coat): 8 m²/l - Per packaging (15 l): 120 m² Color: colourless</p> | | <p>Herramientas: brocha, rodillo Dilución: Diluente Sintetico - 5% Rendimiento (1 capa): 8 m²/l - Por envase (15 l): 120 m² Color: incoloro</p> | |

| tecniche | certificazioni | proprietà | tecnologie |
|----------------------------------|----------------|------------|------------|
| SOLVENT BASED BRUSH ROLLER | | BRILLIANCE | |

thinner fill



scheda
tecnica



data
sheet



ficha
técnica



| | | |
|---|--|--|
| impregnante a solvente interno esterno | high penetrating, water-based fixative indoor outdoor | impregnante de disolvente interior exterior |
| Protettivo del legno a base di resine sintetiche e additivi. Forma un film estremamente sottile, idrorepellente, fortemente resistente agli attacchi di agenti fisici esterni ed alle muffe. Penetra in profondità, non fa da pellicola, è privo di odore ad essiccazione avvenuta. Opaco. Per uso professionale. | Protective finish for wood containing non film-forming synthetic resins and additives. It forms a film that is extremely thin and yet highly water-repellent, resistant to external physical agents as well as to mould and mildew. It penetrates in depth.. Odourless when dry. Matt. For professional use. | Protector para madera con base de resinas sintéticas y aditivos. Forma una película extremadamente fina pero de gran resistencia a los ataques de agentes físicos externos y mohos. Penetra en profundidad, no se exfolia, no tiene olor una vez seco. Mate. Para uso profesional. |
| Attrezzatura: pennello, rullo, spruzzo Diluizione: pronto all'uso Resa (1 mano): 10-12 m ² /l - Per confezione (15 l): 165 m ² Colore: incolore e colorato | Equipment: brush, roller, airless Dilution: ready to use Coverage (1 coat): 10-12 m ² /l - Per packaging (15 l): 165 m ² Color: colourless and colored | Herramientas: brocha, rodillo, pistola pulverizadora Dilución: listo para usar Rendimiento (1 capa): 10-12 m ² /l - Por envase (15 l): 165 m ² Color: incoloro y colorido |

| tecniche | certificazioni | proprietà | tecnologie |
|---|----------------|--------------------|------------|
| SOLVENT BASED BRUSH ROLLER AIRLESS READY TO USE | | matt BRILLIANCE | |

cerato



scheda
tecnica



data
sheet



ficha
técnica



| | | |
|--|--|--|
| impregnante a solvente cerato interno esterno | solvent-based Wax product, impregnating agent indoor outdoor | impregnante de disolvente encerado interior exterior |
| Protettivo del legno a base di resine sintetiche non filmogene e additivi idrorepellenti. Forma un film estremamente sottile, idrorepellente, fortemente resistente agli attacchi di agenti fisici esterni ed alle muffe. Penetra in profondità, non crea una pellicola superficiale, rende il legno estremamente idrorepellente. È privo di odore ad essiccazione avvenuta. Opaco. Per uso professionale. | Protective finish for wood containing non film-forming synthetic resins and water-repellent additives. It forms a film that is extremely thin and yet highly water-repellent, resistant to external physical agents as well as to mould and mildew. It penetrates in depth, does not form a surface film and makes the wood extremely water-repellent. For professional use. | Protector para la madera a base de resinas sintéticas no filmógenas y aditivos hidro-repelentes. Forma una película extremadamente fina, hidro-repelente, de gran resistencia a los ataques de agentes físicos externos y mohos. Penetra en profundidad, no crea película superficial, dota a la madera de una extrema calidad hidro-repelente. Una vez seco, no desprende olor. Mate. Para uso profesional. |
| Attrezzatura: pennello, rullo, spruzzo Diluizione: Diluente Sintetico - 5-10% Resa (1 mano): 9-11 m ² /l - Per confezione (15 l): 150 m ² Colore: incolore e colorato | Equipment: brush, roller, airless Dilution: Diluente Sintetico - 5-10% Coverage (1 coat): 9-11 m ² /l - Per packaging (15 l): 150 m ² Color: colourless and colored | Herramientas: brocha, rodillo, pistola pulverizadora Dilución: Diluente Sintetico - 5-10% Rendimiento (1 capa): 9-11 m ² /l - Por envase (15 l): 150 m ² Color: incoloro y colorido |

| tecniche | certificazioni | proprietà | tecnologie |
|---|----------------|--------------------|------------|
| SOLVENT BASED BRUSH ROLLER AIRLESS | | matt BRILLIANCE | |

idroflattting



scheda
tecnica



data
sheet



ficha
técnica



| finitura per legno all'acqua | interno esterno | water-based finish for wood | indoor outdoor | acabado para madera al agua | interior exterior |
|---|-----------------|--|----------------|---|-------------------|
| Vernice trasparente lucida, di elevato pregio e brillantezza. Garantisce la protezione del supporto dai raggi ultravioletti. Formulata per il trattamento di manufatti lignei situati all'esterno. Per uso professionale. | | Glossy, transparent varnish of high quality and gloss. Ensure protection against ultraviolet light. Formulated to treat wood located outdoors. For professional use. | | Pintura transparente brillante a base de resinas acrílicas, de alta calidad y brillo. Garantizar la protección del soporte contra los rayos ultravioleta. Formulado para el tratamiento de elementos de madera situados en el exterior. Para uso profesional. | |
| Attrezzatura: pennello, rullo, spruzzo Diluizione: acqua - a pennello e rullo 5-10% a spruzzo 10/15% | | Equipment: brush, roller, airless Dilution: water - a brush e roller 5-10% a airless 10/15% | | Herramientas: brocha, rodillo, pistola pulverizadora Dilución: Diluyente Sintetico - 5-15% | |
| Resa (1 mano): 7-8 m ² /l - Per confezione (15 l): 120 m ² Colore: incolore | | Coverage (1 coat): 7-8 m ² /l - Per packaging (15 l): 120 m ² Color: colourless | | Rendimento (1 capa): 7-8 m ² /l - Por envase (15 l): 120 m ² Color: incoloro | |

| tecniche | | | | certificazioni | | | | proprietà | | | | tecnologie | | | | |
|-------------|-------|--------|---------|----------------|--|--|--|------------|--|--|--|------------|--|--|--|--|
| | | | | | | | | | | | | | | | | |
| WATER BASED | BRUSH | ROLLER | AIRLESS | | | | | gloss | | | | | | | | |
| | | | | | | | | BRILLIANCE | | | | | | | | |

idroflattting opaco



scheda
tecnica



data
sheet



ficha
técnica



| finitura per legno all'acqua opaca | interno esterno | waterborne matt finish for wood | indoor outdoor | acabado para madera al agua opaca | interior exterior |
|--|-----------------|---|----------------|--|-------------------|
| Vernice di elevato pregio. Garantisce la protezione del supporto dai raggi ultravioletti. Formulata per il trattamento di manufatti lignei situati all'esterno. Per uso professionale. | | Transparent acrylic resin-based varnish, high quality and gloss finish. Ensure protection against ultraviolet light (greying, discolouration). Formulated to treat wood located outdoors. For professional use. | | Pintura de alta calidad y brillo. Garantizar la protección del soporte contra los rayos ultravioleta (agrisamiento, decoloración). Formulado para el tratamiento de elementos de madera situados en el exterior. Para uso profesional. | |
| Attrezzatura: pennello, rullo, spruzzo Diluizione: acqua - a pennello e rullo 5-10% a spruzzo 10/15% | | Equipment: brush, roller, airless Dilution: water - a brush e roller 5-10% a airless 10/15% | | Herramientas: brocha, rodillo, pistola pulverizadora Dilución: Diluyente Sintetico - 5-15% | |
| Resa (1 mano): 7-8 m ² /l - Per confezione (15 l): 120 m ² Colore: incolore | | Coverage (1 coat): 7-8 m ² /l - Per packaging (15 l): 120 m ² Color: colourless | | Rendimento (1 capa): 7-8 m ² /l - Por envase (15 l): 120 m ² Color: incoloro | |

| tecniche | | | | certificazioni | | | | proprietà | | | | tecnologie | | | | |
|-------------|-------|--------|---------|----------------|--|--|--|------------|--|--|--|------------|--|--|--|--|
| | | | | | | | | | | | | | | | | |
| WATER BASED | BRUSH | ROLLER | AIRLESS | | | | | matt | | | | | | | | |
| | | | | | | | | BRILLIANCE | | | | | | | | |

idrofill



scheda
tecnica



data
sheet



ficha
técnica



| | | | | | |
|--|------------------------|--|-----------------------|---|--------------------------|
| impregnante per legno all'acqua | interno esterno | water-based impregnating agent for wood | indoor outdoor | protector de la madera | interior exterior |
| <p>Protettivo del legno. Forma un film estremamente sottile ma fortemente resistente agli attacchi di agenti fisici esterni ed alle muffe. Penetra in profondità, non creando una pellicola superficiale evita il problema dello sfogliamento. Opaco. Per uso professionale.</p> | | <p>Protective product for wood. It forms a film that is extremely thin and yet highly water-repellent, resistant to external physical agents and mould. It penetrates in depth, does not form a film and thus does not peel. Odourless when dry. Matt. For professional use.</p> | | <p>Protector de la madera. Forma una película extremadamente fina pero de gran resistencia a los ataques de agentes físicos externos y a los mohos. Penetra en profundidad sin actuar como película, por lo cual no se exfolia, una vez seco no tiene olor. Mate. Para uso profesional.</p> | |
| <p>Attrezzatura: pennello, rullo, spruzzo Diluizione: pronto all'uso Resa (1 mano): 10-12 m²/l - Per confezione (15 l): 165 m² Colore: incolore e colorato</p> | | <p>Equipment: brush, roller, airless Dilution: ready to use Coverage (1 coat): 10-12 m²/l - Per packaging (15 l): 165 m² Color: colourless and colored</p> | | <p>Herramientas: brocha, rodillo, pistola pulverizadora Dilución: listo para usar Rendimiento (1 capa): 10-12 m²/l - Por envase (15 l): 165 m² Color: incoloro y colorido</p> | |

| tecniche | certificazioni | proprietà | tecnologie |
|---|----------------|--------------------|------------|
| WATER BASED BRUSH ROLLER AIRLESS READY TO USE | | matt BRILLIANCE | |

idrocerato



scheda
tecnica



data
sheet



ficha
técnica



| | | | | | |
|--|------------------------|---|-----------------------|--|--------------------------|
| impregnante per legno all'acqua cerato | interno esterno | water-based Wax product, impregnating agent for wood | indoor outdoor | protector hidro-repelente para la madera | interior exterior |
| <p>Protettivo del legno a base di resine acriliche e cera, idrorepellente. Forma un film estremamente sottile ma fortemente resistente agli attacchi di agenti fisici esterni ed alle muffe. Penetra in profondità e rende il legno estremamente idrorepellente, è privo di odore. Opaco. Per uso professionale.</p> | | <p>Combination chlorinated rubber resin-based enamel containing weather-resistant pigments. Specially formulated to paint swimming pools. For outdoor use. For professional use.</p> | | <p>Protector hidro-repelente para la madera, a base de resinas acrilicas y cera. Forma una película extremadamente fina pero de gran resistencia a los ataques de agentes físicos externos y mohos. Penetra en profundidad y dota a la madera de una extrema calidad hidro-repelente, no desprende olor. Mate. Para uso profesional.</p> | |
| <p>Attrezzatura: pennello, rullo, spruzzo Diluizione: pronto all'uso Resa (1 mano): 9-10 m²/l - Per confezione (15 l): 140 m² Colore: incolore e colorato</p> | | <p>Equipment: brush, roller, airless Dilution: ready to use Coverage (1 coat): 9-10 m²/l - Per packaging (15 l): 140 m² Color: colourless and colored</p> | | <p>Herramientas: brocha, rodillo, pistola pulverizadora Dilución: listo para usar Rendimiento (1 capa): 9-10 m²/l - Por envase (15 l): 140 m² Color: incoloro y colorido</p> | |

| tecniche | certificazioni | proprietà | tecnologie |
|---|----------------|--------------------|------------|
| WATER BASED BRUSH ROLLER AIRLESS READY TO USE | | matt BRILLIANCE | |

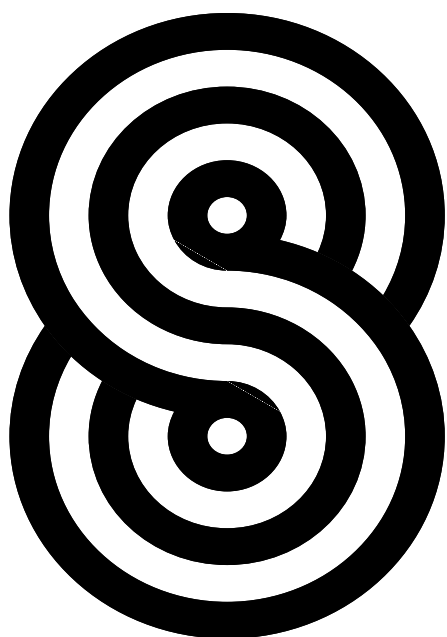

termok8[®]

ISOL AMME NITO TER MICO



termok

finiture per cappotto Leeder in Italia

linee prodotti

collanti e rasanti

collanti e rasanti ht

collanti-fuganti TermoK8 modular

isolanti

tasselli ht

tasselli

accessori ht

accessori

elementi di fissaggio

davanzali

reti in fibra di vetro

finiture

rivestimenti modulari

decori e cornici

attezzature

8

klebocem



scheda
tecnica



data
sheet



ficha
técnica



| collante/rasante in polvere | interno esterno | adhesive/skim coat in powder form | indoor outdoor | cola/mortero de enrasado en polvo | interior exterior |
|--|-----------------|--|----------------|---|-------------------|
| Adesivo/rasante minerale eco-compatibile in polvere a base di resine insaponificabili, Cemento Portland ad alta resistenza e sabbie selezionate granulometria max 0,6mm. Specifico per l'incollaggio e la rasatura di pannelli isolanti nei cicli Termok8 [®] e per ciclo armato Rasoprotection. Per uso professionale. | | Eco-friendly mineral adhesive/skim coat in powder form made of unsaponifiable resins, high-resistance Portland cement and selected sands with a maximum particle size of 0.6 mm. Specifically formulated for gluing and skimming of insulating panels in Termok8 [®] processes and Rasoprotection reinforced process. For professional use. | | Adesivo/mortero de enrasado eco-compatibile en polvo a base de resinas insaponificables, Cemento Portland de alta resistencia y arenas seleccionadas granulometria máx 0,6 mm. Especifico para el encolado y enrasado de paneles aislantes en los ciclos Termok8 [®] y para ciclo armado Rasoprotection. Para uso profesional. | |
| Granulometria: 0,6 mm Attrezzatura: spatola, cazzuola, frattazzo di spugna, impastatrice a basso numero di giri Rapporto di miscelazione: acqua - 22-24% Consumo: 1,3 kg/m ² per mm di spessore; per incollare 4-4,5 kg/m ² - per rasare 4-4,5 kg/m ² | | Particle size: 0.6 mm Equipment: spatula, mason's trowel, sponge trowel, low speed mixer Mixing ratio: water - 22-24%. Recommended use: 1.3 kg/m ² per mm di thickness; for gluing 4-4.5 kg/m ² - for skimming 4-4.5 kg/m ² | | Granulometria: 0,6 mm Herramientas: espátula, paleta, llana de esponja, amasadora de bajo número de revoluciones Relación de mezcla: agua - 22-24 % Consumo: 1,3 kg/m ² por mm de espesor; para encolar 4-4,5 kg/m ² - para enrasar 4-4,5 kg/m ² | |

| tecniche | certificazioni | proprietà | tecnologie |
|-----------------------|----------------|-----------|------------|
| WATER BASED TROWEL | | | |

klebocem grosso



scheda
tecnica



data
sheet



ficha
técnica



| collante/rasante in polvere | interno esterno | adhesive/skim coat in powder form | indoor outdoor | cola/mortero de enrasado en polvo | interior exterior |
|---|-----------------|---|----------------|---|-------------------|
| Adesivo/rasante minerale eco-compatibile in polvere a base di resine insaponificabili, Cemento Portland ad alta resistenza e sabbie selezionate, granulometria max 1,2mm. Specifico per la rasatura di pannelli isolanti nei cicli Termok8 [®] quando è necessario ottenere spessori elevati con l'uso di rete Armatex C1 M o C1 R. Per uso professionale. | | Eco-friendly mineral adhesive/skim coat in powder form made of unsaponifiable resins, high-resistance Portland cement and selected sands, maximum particle size of 1.2mm. Specifically formulated for skimming insulating panels used in Termok8 [®] processes when high thicknesses need to be obtained using an Armatex C1 M or C1 R mesh. For professional use. | | Adesivo/mortero de enrasado eco-compatibile en polvo a base de resinas insaponificables, Cemento Portland de alta resistencia y arenas seleccionadas, granulometria máx. 1,2 mm. Especifico para el enrasado de paneles aislantes en los ciclos Termok8 [®] cuando es necesario obtener espesores altos con el uso de malla Armatex C1 M o C1 R. Para uso profesional. | |
| Granulometria: 1,2 mm Attrezzatura: spatola, cazzuola, frattazzo di spugna, impastatrice a basso numero di giri Rapporto di miscelazione: acqua - 22-24% Consumo: 1,3 kg/m ² per mm di spessore; per incollare 4-4,5 kg/m ² - per rasare 4-4,5 kg/m ² | | Particle size: 1.2 mm Equipment: spatula, mason's trowel, sponge trowel, low speed mixer Mixing ratio: water - 22-24%. Recommended use: 1.3 kg/m ² per mm of thickness; for gluing 4-4.5 kg/m ² - for skimming 4-4.5 kg/m ² | | Granulometria: 1,2 mm Herramientas: espátula, paleta, llana de esponja, amasadora de bajo número de revoluciones Relación de mezcla: agua - 22-24 % Consumo: 1,3 kg/m ² por mm de espesor; para encolar 4-4,5 kg/m ² - para enrasar 4-4,5 kg/m ² | |

| tecniche | certificazioni | proprietà | tecnologie |
|-----------------------|----------------|-----------|------------|
| WATER BASED TROWEL | | | |

adefix 12 grigio



scheda
tecnica



data
sheet



ficha
técnica



| collante/rasante in polvere | interno esterno | adhesive/skim coat in powder form | indoor outdoor | cola/mortero de enrasado en polvo | interior exterior |
|--|------------------------|--|-----------------------|--|--------------------------|
| Adesivo/rasante minerale eco-compatibile in polvere dotato di ottime caratteristiche adesivanti e resistenza ai cicli di gelo e disgelo. A base di resine insaponificabili, Cemento Portland ad alta resistenza e sabbie selezionate. Ottima spatolabilità e riempimento, idoneo per incollaggio, rasature anche armate con rete di rinforzo, su intonaci cavillati, cemento armato, pannelli isolanti. Per uso professionale. | | Eco-friendly mineral adhesive/skim coat in powder form with superb adhesive properties and resistance to freeze-thaw cycles. Made of unsaponifiable resins, high resistance Portland cement and selected sands. Superb filling capacity and trowel applicability. Suitable for gluing, skim coats (even mesh-reinforced), cracked plaster, reinforced concrete, insulating panels. For professional use. | | Adhesivo/rasante mineral eco-compatibile en polvo dotado de óptimas características adhesivas y resistencia a los ciclos de congelación y deshielo. A base de resinas insaponificables, Cemento Portland de alta resistencia y arena seleccionadas. Óptima spatolabilidad y llenado, idóneo para encolado, rasaduras también armadas con red de refuerzo, sobre enlucidos cavilados, hormigón armado, paneles aislantes. Para uso profesional. | |
| Granulometria: 0,8 mm, (Adefix 12 Grigio Grosso: 1,2 mm) Attrezzatura: spatola, cazzuola, frattazzo di spugna, impastatrice a basso numero di giri Rapporto di miscelazione: acqua - 22-24% Consumo: 1,3 kg/m ² per mm di spessore; Per Incollare: 4-4,5 kg/m ² - Per Rasare: 4-4,5 kg/m ² | | Particle size: 0.8 mm, (Adefix 12 Grey Coarse: 1.2 mm) Equipment: spatula, mason's trowel, sponge trowel, low speed mixer Mixing ratio: water - 22-24%. Recommended use: 1.3 kg/m ² per mm of thickness; For gluing: 4-4.5 kg/m ² - For Skimming: 4-4.5 kg/m ² | | Granulometría: 0,8 mm, (Adefix 12 Gris Grueso: 1,2 mm) Herramientas: espátula, paleta, llana de esponja, amasadora de bajo número de revoluciones Relación de mezcla: agua - 22-24 % Consumo: 1,3 kg/m ² por mm de espesor; Para encolar: 4-4,5 kg/m ² - Para enrasar: 4-4,5 kg/m ² | |

| tecniche | certificazioni | proprietà | tecnologie |
|--|---|-----------|------------|
|   |    | | |

adefix 12 bianco



scheda
tecnica







data
sheet



ficha
técnica



| collante/rasante in polvere bianco | interno esterno | white adhesive/skim coat in powder form | indoor outdoor | cola/mortero de enrasado en polvo blanco | interior exterior |
|--|------------------------|---|-----------------------|---|--------------------------|
| Adesivo/rasante minerale eco-compatibile in polvere dotato di ottime caratteristiche adesivanti e resistenza ai cicli di gelo e disgelo. A base di resine insaponificabili, Cemento Bianco ad alta resistenza e sabbie selezionate. Ottima spatolabilità e riempimento, idoneo per incollaggio, rasature anche armate con rete di rinforzo, su intonaci cavillati, cemento armato, pannelli isolanti. Per uso professionale. | | Eco-friendly mineral adhesive/skim coat in powder form with superb adhesive properties and resistance to freeze-thaw cycles. Made of unsaponifiable resins, high resistance White Cement and selected sands. Superb filling capacity and trowel applicability. Suitable for gluing, skim coats (even mesh-reinforced), cracked plaster, reinforced concrete, insulating panels. For professional use. | | Adhesivo/rasante mineral eco-compatibile en polvo dotado de óptimas características adhesivas y resistencia a los ciclos de congelación y deshielo. A base de resinas insaponificables, Cemento Blanco de alta resistencia y arenas seleccionadas. Óptima spatolabilidad y llenado, idóneo para encolado, rasaduras también armadas con red de refuerzo, sobre enlucidos cavilados, hormigón armado, paneles aislantes. Para uso profesional. | |
| Granulometria: 0,8 mm (Adefix 12 Bianco Grosso: 1,2 mm) Attrezzatura: spatola, cazzuola, frattazzo di spugna, impastatrice a basso numero di giri Rapporto di miscelazione: acqua - 22-24% Consumo: 1,3 kg/m ² per mm di spessore; Per Incollare: 4-4,5 kg/m ² - Per Rasare: 4-4,5 kg/m ² | | Particle size: 0.8 mm (Adefix 12 white coarse: 1.2 mm) Equipment: spatula, mason's trowel, sponge trowel, low speed mixer Mixing ratio: water - 22-24%. Recommended use: 1.3 kg/m ² per mm of thickness; For gluing: 4-4.5 kg/m ² - For Skimming: 4-4.5 kg/m ² | | Granulometría: 0,8 mm (Adefix 12 Blanco Grueso: 1,2 mm) Herramientas: espátula, paleta, llana de esponja, amasadora de bajo número de revoluciones Relación de mezcla: agua - 22-24 % Consumo: 1,3 kg/m ² por mm de espesor; Para encolar: 4-4,5 kg/m ² - Para enrasar: 4-4,5 kg/m ² | |

| tecniche | certificazioni | proprietà | tecnologie |
|--|---|-----------|------------|
|   |    | | |

Iecocem 100

scheda
tecnicadata
sheetficha
técnica

| collante/rasante plastico in pasta | esterno | plastic adhesive/skim coat in paste form | outdoor | cola/mortero de enrasado plástico en pasta | exterior |
|---|---------|--|---------|--|----------|
| Collante/rasante plastico in pasta specifico per polistirene espanso estruso, fibre minerali e lana di vetro. A base di resine in dispersione insaponificabili e sabbie selezionate, dotato di ottime caratteristiche adesivanti, idoneo per rasature armate con rete di rinforzo su intonaci cavillati, cemento, polistirolo espanso ed estruso, lana di vetro e quale collante per lastre di polistirolo in genere e in fibre minerali per Termok8®. Per uso professionale. | | Plastic adhesive/skim coat in paste form, specific for extruded polystyrene foam, mineral fibres and glass fibres. Based on unsaponifiable resins in dispersion and selected sands, provides excellent adhesive properties. Ideal for mesh-reinforced skim coats on cracked plasters, cement, extruded polystyrene foam, glass fibre and as an adhesive for sheets of polystyrene in general and mineral fibres for Termok8® system. For professional use. | | Cola/mortero de enrasado plástico en pasta específico para poliestireno expandido extruido, fibras minerales y lana de vidrio. A base de resinas insaponificables en dispersión y arenas seleccionadas, dotado de excelentes características de adhesión, idóneo para enrasados armados con malla de refuerzo sobre enfoscados cuarteados, cemento, poliestireno expandido y extruido, lana de vidrio, y como cola para placas de poliestireno en general y en fibras minerales para Termok8®. Para uso profesional. | |
| Granulometria: <0,5 mm Attrezzatura: spatola, cazzuola, impastatrice a basso numero di giri Rapporto di miscelazione: Cemento PTL 325 - 100% Consumo: 1,3 kg/m ² per mm di spessore; Per Incollare: 4-4,5 kg/m ² - Per Rasare: 4-4,5 kg/m ² | | Particle size: <0.5 mm Equipment: spatula, mason's trowel, low speed mixer. Mixing ratio: PTL cement 325 - 100% Recommended use: 1.3 kg/m ² per mm of thickness; For gluing: 4-4.5 kg/m ² - For Skimming: 4-4.5 kg/m ² | | Granulometría: <0,5 mm Herramientas: espátula, paleta, amasadora de bajo número de revoluciones Relación de mezcla: Cemento PTL 325 - 100 % Consumo: 1,3 kg/m ² por mm de espesor; Para encolar: 4-4,5 kg/m ² - Para enrasar: 4-4,5 kg/m ² | |





| tecniche | | certificazioni | | | | proprietà | | | | tecnologie | | | |
|--|---|----------------|--|--|--|-----------|--|--|--|------------|--|--|--|
|  |  | | | | | | | | | | | | |



klebocem termico

scheda
tecnicadata
sheetficha
técnica

| collante/rasante termico in polvere | interno esterno | thermal adhesive/skim coat in powder form | indoor outdoor | cola/mortero de enrasado térmico en polvo | interior exterior |
|---|-----------------|--|----------------|---|-------------------|
| Adesivo/rasante minerale eco-compatibile ad elevata prestazione termica con ottime caratteristiche adesivanti e di resistenza ai cicli di gelo e disgelo. Collante/rasante in polvere alleggerito con sfere di vetro cavo a base di Cemento Portland ad alta resistenza, sabbie selezionate e resine insaponificabili. Idoneo per l'incollaggio di pannelli isolanti nei cicli Termok8 [®] , per rasature, rasature armate con rete di rinforzo, su intonaci cavillati, cemento armato. Per uso professionale. | | Eco-friendly mineral adhesive/skim coat in powder form with high thermal performance, superb adhesive properties and resistance to freeze-thaw cycles. Adhesive/skim coat in powder form made of high resistance Portland cement, lightened with hollow glass beads, selected sands and unsaponifiable resins. Suitable for gluing insulating panels in Termok8 [®] processes, for skimming, applying mesh-reinforced skim coats on cracked plaster, reinforced concrete. For professional use. | | Adhesivo/mortero de enrasado mineral eco-compatibile de altas prestaciones térmicas con excelentes características de adhesión y resistencia a los ciclos de hielo y deshielo. Cola/mortero de enrasado en polvo aligerado con esferas de vidrio hueco, a base de Cemento Portland de alta resistencia, arenas seleccionadas y resinas insaponificables. Idóneo para el encolado de paneles aislantes en los ciclos Termok8 [®] , para enrasados, enrasados armados con malla de refuerzo, sobre enfoscados cuarteados, hormigón armado. Para uso profesional. | |
| Granulometria: 1 mm Attrezzatura: spatola, cazzuola, frattazzo di spugna, impastatrice a basso numero di giri Rapporto di miscelazione: acqua - 29-31% Consumo: 0,9 kg/m ² per mm di spessore; Per Incollare: 2,7-3,2 kg/m ² - Per Rasare: 2,7-3,2 kg/m ² | | Particle Size: 1 mm Equipment: spatula, mason's trowel, sponge trowel, low speed mixer Mixing ratio: water - 29-31%. Recommended use: 0.9 kg/m ² per mm of thickness; For gluing: 2.7-3.2 kg/m ² - For Skimming: 2.7-3.2 kg/m ² | | Granulometría: 1 mm Herramientas: espátula, paleta, llana de esponja, amasadora de bajo número de revoluciones Relación de mezcla: agua - 29-31 % Consumo: 0,9 kg/m ² por mm de espesor; Para encolar: 2,7-3,2 kg/m ² - Para enrasar: 2,7-3,2 kg/m ² | |

| tecniche | certificazioni | proprietà | tecnologie |
|--|---|---|------------|
|  WATER BASED  TROWEL |  |  | |

klebocem fibrato

scheda
tecnicadata
sheetficha
técnica

| collante/rasante fibrorinforzato | interno esterno | fibre-reinforced adhesive/skim coat | indoor outdoor | cola/mortero de enrasado fibrorreforzado | interior exterior |
|---|-----------------|--|----------------|---|-------------------|
| Adesivo/rasante minerale eco-compatibile in polvere additivato con fibre poliammidiche, con ottime caratteristiche adesivanti e resistenza ai cicli di gelo e disgelo. Particolarmente indicato per rasature armate su intonaci cavillati e cemento armato. Idoneo anche come rasante nei cicli Termok8. Prodotto verificato secondo le norme UNI EN 998-1 per l'uso del marchio CE. Per uso professionale. | | Eco-friendly mineral adhesive/skim coat in powder form with the addition of polyamide fibres. Superb adhesive properties and resistance to freeze-thaw cycles. Particularly suitable for reinforced skim coats applied on cracked plaster and reinforced concrete. Also suitable as skim coat For the Termok8 processes. Product tested according to UNI EN 998-1 for use of CE marking. For professional use. | | Adhesivo/mortero de enrasado mineral eco-compatibile en polvo con aditivo de fibras poliamidicas, dotado de excelentes características de adhesión y resistencia a los ciclos de hielo y deshielo. Particularmente indicado para enrasados armados sobre enfoscados cuarteados y hormigón armado. Idóneo también como mortero de enrasado en los ciclos Termok8. Producto verificado conforme a las normas UNI EN 998-1 para el uso de la marca CE. Para uso profesional. | |
| Granulometria: max 0,6 mm Attrezzatura: spatola, cazzuola, frattazzo di spugna, impastatrice a basso numero di giri Rapporto di miscelazione: acqua - 22-24% Consumo: 1,3 kg/m ² per mm di spessore; Per Incollare: 4-4,5 kg/m ² - Per Rasare: 4-4,5 kg/m ² | | Particle Size: max 0.6 mm Equipment: spatula, mason's trowel, sponge trowel, low speed mixer Mixing ratio: water - 22-24%. Recommended use: 1.3 kg/m ² per mm of thickness; For gluing: 4-4.5 kg/m ² - For Skimming: 4-4.5 kg/m ² | | Granulometría: máx. 0,6 mm Herramientas: espátula, paleta, llana de esponja, amasadora de bajo número de revoluciones Relación de mezcla: agua - 22-24 % Consumo: 1,3 kg/m ² por mm de espesor; Para encolar: 4-4,5 kg/m ² - Para enrasar: 4-4,5 kg/m ² | |

| tecniche | certificazioni | proprietà | tecnologie |
|--|---|-----------|------------|
|  WATER BASED  TROWEL |  | | |

klebocem ultra



scheda
tecnica



data
sheet



ficha
técnica



| | | | | | |
|---|------------------------|---|-----------------------|---|--------------------------|
| collante/rasante per Termok8 Modulari | interno esterno | adhesive/skim coat for Termok8 modular systems | indoor outdoor | cola/mortero de enrasado para Termok8 Modulares | interior exterior |
| <p>Adesivo/rasante minerale eco-compatibile ad adesione migliorata a base di resine insaponificabili, Cemento Portland ad alta resistenza e sabbie selezionate. Possiede ottime caratteristiche adesivanti e resistenza ai cicli di gelo e disgelo. Idoneo per incollare e rasare i pannelli isolanti tipo FIX per Termok8 Modulari. Per uso professionale.</p> | | <p>Eco-friendly mineral adhesive/skim coat with adhesion properties boosted by the use of unsaponifiable resins, high-resistance Portland cement and selected sands. It offers superb adhesive properties and resistance to freeze-thaw cycles. Suitable for gluing and skimming FIX-type insulating panels For the Termok8: modular systems. For professional use.</p> | | <p>Adhesivo/mortero de enrasado mineral eco-compatibile de adhesión mejorada a base de resinas insaponificables, Cemento Portland de alta resistencia y arenas seleccionadas. Posee excelentes características de adhesión y resistencia a los ciclos de hielo y deshielo. Idóneo para encolar y enrasar paneles aislantes tipo FIX para Termok8 Modulares. Para uso profesional.</p> | |
| <p>Granulometria: max 0,8 mm Attrezzatura: spatola, cazzuola, frattazzo di spugna, impastatrice a basso numero di giri Rapporto di miscelazione: acqua - 22-24% Consumo: 1,3 kg/m² per mm di spessore; Per Incollare: 4-4,5 kg/m² - Per Rasare: 4-4,5 kg/m²</p> | | <p>Particle Size: max 0.8 mm Equipment: spatula, mason's trowel, sponge trowel, low speed mixer Mixing ratio: water - 22-24%. Recommended use: 1.3 kg/m² per mm of thickness; For gluing: 4-4.5 kg/m² - For Skimming: 4-4.5 kg/m²</p> | | <p>Granulometría: máx. 0,8 mm Herramientas: espátula, paleta, llana de esponja, amasadora de bajo número de revoluciones Relación de mezcla : agua - 22-24 % Consumo: 1,3 kg/m² por mm de espesor; Para encolar: 4-4,5 kg/m² - Para enrasar: 4-4,5 kg/m²</p> | |

| tecniche | | | certificazioni | | | proprietà | | | tecnologie | | |
|----------|--|--|----------------|--|--|-----------|--|--|------------|--|--|
| | | | | | | | | | | | |

klebocem R 110 J



scheda
tecnica



data
sheet



ficha
técnica



| | | | | | |
|---|------------------------|---|-----------------------|---|--------------------------|
| collante/rasante ad elevate resistenze agli urti | interno esterno | high impact resistance adhesive/skim coat | indoor outdoor | cola/mortero de enrasado de alta resistencia a los golpes | interior exterior |
| <p>Collante e rasante fibrato addizionato con materie prime termoplastiche ideale come rasante per ciclo Termok8 AR Max 60 J e per cicli di isolamento a cappotto con resistenze all'urto fino a 110 J. Prodotto verificato secondo le norme UNI EN 998-1 (tipo LW CS III W 2) per l'uso del marchio CE. Per uso professionale.</p> | | <p>Fibre-based adhesive/skim coat with added thermoplastic raw materials, ideal as skimming plaster For the Termok8: AR Max 60 J systems and for thermal insulation processes with impact resistance rated up to 110 J. Product tested according to UNI EN 998-1 (type LW CS III W 2) for use of CE marking. For professional use.</p> | | <p>Cola y mortero de enrasado fibrado, con materias primas termoplásticas añadidas, ideal como mortero de enrasado para ciclo Termok8 AR Max 60 J y para ciclos de aislamiento por capas con resistencias al impacto de hasta 110 J. Producto verificado según las normas UNI EN 998-1 (tipo LW CS III W 2) para el uso de la marca CE. Para uso profesional.</p> | |
| <p>Granulometria: max 1 mm Attrezzatura: spatola, cazzuola, frattazzo di spugna, impastatrice a basso numero di giri Rapporto di miscelazione: acqua - 34-36% Consumo: 0,6 Kg/m² per mm di spessore; Per Rasare: 5-5,5 Kg/m² su lastra zigrinata</p> | | <p>Particle Size: max 1 mm Equipment: spatula, mason's trowel, sponge trowel, low speed mixer Mixing ratio: water - 34-36%. Recommended use: 0.6 Kg/m² per mm of thickness; For Skimming: 5- 5.5 Kg/m² on corrugated sheet</p> | | <p>Granulometría: máx. 1 mm Herramientas: espátula, paleta, llana de esponja, amasadora de bajo número de revoluciones Relación de mezcla : agua - 34-36% Consumo: 0,6 Kg/m² por mm de espesor; Para enrasar: 5-5,5 Kg/m² sobre placa moleteada</p> | |

| tecniche | | | certificazioni | | | proprietà | | | tecnologie | | |
|----------|--|--|----------------|--|--|-----------|--|--|------------|--|--|
| | | | | | | | | | | | |

klebocem minerale

scheda
tecnicadata
sheetficha
técnica

| collante/rasante per termok8 minerali | interno esterno | adhesive/skim coat for mineral termok8 systems | indoor outdoor | cola/mortero de enrasado para termok8 minerales | interior exterior |
|--|--------------------|--|-------------------|---|----------------------|
| Adesivo/rasante minerale eco-compatibile in polvere particolarmente indicato nei rivestimenti a cappotto di tipo minerale e per isolanti bio-compatibili. Specifico per l'incollaggio di pannelli isolanti naturali o minerali (sughero, lana di roccia, lana di vetro, ecc.) utilizzabile anche su pannelli in EPS bianco o grigio nei cicli Termok8®. Per uso professionale. | | Eco-friendly mineral adhesive/skim coat in powder form particularly suitable for mineral-based external thermal insulation systems and eco-compatible insulation. Specific for gluing natural or mineral insulating panels (cork, rock wool, glass fibre, etc.). Can also be used on white or grey EPS panels in the Termok8® processes. For professional use. | | Adhesivo/mortero de enrasado mineral eco-compatibile en polvo particularmente indicado para revestimientos por capas de tipo mineral y para aislantes bio-compatibles. Especifico para el encolado de paneles aislantes naturales o minerales (corcho, lana de roca, lana de vidrio, etc.), utilizable también con paneles de EPS blanco o gris en los ciclos Termok8®. Para uso profesional. | |
| Granulometria: max 0,6 mm Attrezzatura: spatola, cazzuola, frattazzo di spugna, impastatrice a basso numero di giri Rapporto di miscelazione: acqua - 22-24% Consumo: 1,3 kg/m ² per mm di spessore; Per Incollare: 4-4,5 kg/m ² - Per Rasare: 4-4,5 kg/m ² | | Particle Size: max 0.6 mm Equipment: spatula, mason's trowel, sponge trowel, low speed mixer Mixing ratio: water - 22-24%. Recommended use: 1.3 kg/m ² per mm of thickness; For gluing: 4-4.5 kg/m ² - For Skimming: 4-4.5 kg/m ² | | Granulometria: máx. 0,6 mm Herramientas: espátula, paleta, llana de esponja, amasadora de bajo número de revoluciones Relación de mezcla: agua - 22-24 % Consumo: 1,3 kg/m ² por mm de espesor; Para encolar: 4-4,5 kg/m ² - Para enrasar: 4-4,5 kg/m ² | |

| tecniche | certificazioni | proprietà | tecnologie |
|--|---|-----------|------------|
|  WATER BASED  TROWEL |  CE EN 998-1 GPCSIV  EPD | | |

klebocalce naturale

scheda
tecnicadata
sheetficha
técnica

| collante/rasante a base di calce idraulica | interno esterno | hydraulic lime-based adhesive/skim coat | indoor outdoor | cola/mortero de enrasado a base de cal hidráulica | interior exterior |
|---|--------------------|---|-------------------|--|----------------------|
| Collante/rasante a base di Calce Idraulica specifico per l'incollaggio e la rasatura di pannelli isolanti naturali o minerali nei cicli Termok8. Il prodotto unisce la lavorabilità e traspirabilità della Calce Idraulica Naturale (Natural Hydraulic Lime 3.5, UNI-EN 459-1_2010), a quelle di forza e rapidità di presa del Roman Cement (Ciment Prompt Naturel, NF P 15-314). Totalmente 'Portland Free', rappresenta la soluzione ideale per l'edilizia verde e il recupero architettonico. Per uso professionale. | | Hydraulic lime-based adhesive/skim coat specifically designed for gluing and skimming natural or mineral insulating panels in Termok8 processes. The product blends the workability and breathability of Natural Hydraulic Lime (Natural Hydraulic Lime 3.5, UNI-EN 459-1_2010) with the fast setting properties of Roman Cement (Ciment Prompt Naturel, NF P 15-314). Totally 'Portland Free'. The ideal solution for green construction and architectural renovation. For professional use. | | Cola/mortero de enrasado a base de cal hidráulica, específica para el encolado y el enrasado de paneles aislantes naturales o minerales en los ciclos Termok8. El producto une la facilidad de elaboración y transpirabilidad de la Cal Hidráulica Natural (Natural Hydraulic Lime 3.5, UNI-EN 459-1_2010), a las de fuerza y rapidez de fraguado del Roman Cement (Ciment Prompt Naturel, NF P 15-314). Totalmente 'Portland Free', representa la solución ideal para la construcción ecológica y la recuperación arquitectónica. Para uso profesional. | |
| Granulometria: max 0,6 mm Attrezzatura: spatola, cazzuola, frattazzo di spugna, impastatrice a basso numero di giri Rapporto di miscelazione: acqua - 30-32% Consumo: 1,1 kg/m ² per mm di spessore; Per Incollare: 3,5-4 kg/m ² - Per Rasare: 3,5-4 kg/m ² | | Particle Size: max 0.6 mm Equipment: spatula, mason's trowel, sponge trowel, low speed mixer Mixing ratio: water - 30-32%. Recommended use: 1.1 kg/m ² per mm of thickness; For gluing: 3.5-4 kg/m ² - For Skimming: 3.5-4 kg/m ² | | Granulometria: máx. 0,6 mm Herramientas: espátula, paleta, llana de esponja, amasadora de bajo número de revoluciones Relación de mezcla: agua - 30-32% Consumo: 1,1 kg/m ² por mm de espesor; Para encolar: 3,5-4 kg/m ² - Para enrasar: 3,5-4 kg/m ² | |

| tecniche | certificazioni | proprietà | tecnologie |
|--|---|-----------|------------|
|  WATER BASED  TROWEL |  CE EN 998-1 GPCSIIV | | |

rasogum



scheda
tecnica



data
sheet



ficha
técnica



| rasante cementizio elastomerico | interno esterno | elastomeric cement-based skim coat | indoor outdoor | mortero de cemento elastomérico | interior exterior |
|---|-----------------|--|----------------|--|-------------------|
| Rasante plastico in pasta da additarsi con cemento PTL 325 a base di resine in dispersione insaponificabili e sabbie selezionate, dotato di ottime caratteristiche adesivanti, ottima spatolabilità e riempimento. L'addizione con resine elastomeriche lo rende idoneo per rasature anche armate con rete di rinforzo Armatex all'interno del ciclo Rasoprotection. Per uso professionale. | | Plastic skim coat in paste form to which PTL 325 cement is to be added. Contains unsaponifiable resins in dispersion and selected sands. Offers excellent adhesion, filling capacity and trowel applicability properties. The addition of elastomeric resins makes it suitable for skimming, even when Armatex reinforcement mesh is used with the Rasoprotection process. For professional use. | | Mortero de enrasado plástico en pasta, para aditivar con cemento PTL 325 a base de resinas en dispersión insaponificables y arenas seleccionadas, dotado de excelentes características de adhesión, excelente facilidad para la extensión con espátula y para relleno. El aditivado con resinas elastoméricas lo hace idóneo para enrasados incluso armados con malla de refuerzo Armatex dentro del ciclo Rasoprotection. Para uso profesional. | |
| Granulometria: max 1 mm Attrezzatura: spatola, cazzuola, frattazzo di spugna, impastatrice a basso numero di giri Rapporto di miscelazione: 30% con cemento PTL 325 Resa: 1 kg/m ² per mm di spessore; Per Rasare: 3-3,5 kg/m ² Colore: grigio | | Particle Size: max 1 mm Equipment: spatula, mason's trowel, sponge trowel, low speed mixer Mixing ratio: 30% with PTL 325 cement Coverage: 1Kg/ m ² per mm of thickness; For skimming: 3-3.5 kg/m ² Color: grey | | Granulometría: máx. 1 mm Herramientas: espátula, paleta, llana de esponja, amasadora de bajo número de revoluciones Relación de mezcla: 30% con cemento PTL 325 Rendimiento: 1 kg/m ² por mm de espesor; Para enrasar: 3-3,5 kg/m ² Color: gris | |

| tecniche | certificazioni | proprietà | tecnologie |
|-----------------------|----------------|-----------|------------|
| WATER BASED TROWEL | | | |

TermoK8 foam



scheda
tecnica



data
sheet



ficha
técnica



| schiuma adesiva poliuretanic | esterno | polyurethane adhesive foam | outdoor | espuma adhesiva poliuretánica | exterior |
|--|---------|--|---------|---|----------|
| Adesivo in schiuma poliuretanic studiato per il fissaggio di pannelli di polistirolo espanso alle pareti esterne di edifici per l'isolamento termico, per davanzali. Caratterizzato da un'eccellente adesione su molti materiali come cemento, intonaco, mattoni, legno, metallo, polistirolo espanso XPS polistirolo ed estruso. Per uso professionale. | | Polyurethane foam adhesive designed to secure expanded polystyrene panels to outside walls to achieve thermal building insulation, for window sills. It adheres well to many materials such as concrete, plaster, brick, wood, metal, polystyrene foam, XPS extruded polystyrene foam. For professional use. | | Adhesivo en espuma poliuretánica studiado para la fijación de paneles de poliestireno expandido a las paredes externas de edificios para el aislamiento térmico; para alféizares. Se caracteriza por una excelente adhesión sobre muchos materiales como cemento, enfoscados, ladrillos, metal, poliestireno expandido XPS y poliestireno extruido. Para uso profesional. | |
| Diluizione: pronto all'uso Confezione: 1 scatola da 12 pezzi da 0,750 ml | | Dilution: ready to use Package: 1 box da 12 pezzi da 0,750 ml | | Dilución: listo para usar Envase: 1 caja de 12 piezas de 0,750 ml | |

sigil pol



scheda
tecnica



data
sheet



ficha
técnica



| sigillante elastico sovraverniciabile | flexible sealant that can be overpainted | sellador elástico, admite recubrimiento de pintura |
|---|--|---|
| Sigillante elastico Poliuretanic monocomponente igroindurente, sovraverniciabile. | One-pack, elastic, moisture-hardening polyurethane sealant. Can be overpainted. | Sellador elástico Poliuretanic monocomponente higroendurecible, admite recubrimiento de pintura. |
| Applicazione: estrusori pneumatici o manuali Resa: 100-150 g/m/cm ² | Application: pneumatic or manual extruder Coverage: 100-150 g/m/cm ² | Aplicación: extrusores neumáticos o manuales Rendimiento: 100-150 g/m ² |

glueflex modular big grigio



scheda
tecnica



data
sheet



ficha
técnica



| adesivo cementizio bicomponente grigio | interno esterno | two-pack ce- ment-based adhesive - grey | indoor outdoor | adhesivo cementoso bicomponente gris | interior exterior |
|---|--------------------|---|-------------------|---|----------------------|
| Adesivo cementizio bicomponente A (polvere cementizia) B (resina elasticizzante), specifico per la posa a pavimento e a parete di piastrelle ceramiche (gres porcellanato, cotto, klinker, ecc.), materiale lapideo e mosaici, non assorbenti, di grande formato. Resistenza all'umidità: ottima. Resistenza ai solventi e acidi: ottima. Per uso professionale. | | Two-pack cement-based adhesive — A (cement powder) B (elasticizing resin) — specifically formulated for laying of large, non-absorbent ceramic (porcelain stoneware, terracotta, klinker, etc.), stone and mosaic wall and floor tiles. Moisture resistance: excellent. Resistance to solvents and acids: excellent For professional use. | | Adhesivo cementoso bicomponente A (polvo de cemento) B (resina elástica), específico para la colocación en suelos y paredes de baldosas cerámicas (gres porcelánico, barro cocido, klinker, etc.), material lapídeo y mosaicos, no absorbentes, de gran formato. Resistencia a la humedad: excelente. Resistencia a los disolventes y ácidos: excelente. Para uso profesional. | |
| Granulometria: max 0,5 mm Attrezzatura: spatola dentata, cazzuola, impastatrice a basso numero di giri Rapporto di miscelazione: 30% con componente B - 7,6 kg per confezione da 25 Kg Consumo: Mosaici Piccoli formati 2 kg/m ² - standard 2,5-3,5 2 kg/m ² - Grandi 5,5-6,5 2 kg/m ² Per sistema: Termok8 Modular Big | | Particle Size: max 0.5 mm Equipment: serrated spatula, mason's trowel, low speed mixer. Mixing ratio: 30% with component B - 7.6 kg for 25 kg package Recommended use: Small mosaic tiles 2 kg/m ² - standard 2.5-3.5 2 kg/m ² - Large 5.5-6.5 2 kg/m ² For: Termok8 Modular Big system | | Granulometría: máx. 0,5 mm Herramientas: espátula dentada, paleta, amasadora de bajo número de revoluciones Relación de mezcla: 30 % con componente B - 7,6 kg por envase de 25 Kg Consumo: Mosaicos de pequeño formato 2 kg/m ² - estándar 2,5-3,5 2 kg/m ² - Grandes 5,5-6,5 2 kg/m ² Para sistema: Termok8 Modular Big | |

| tecniche | certificazioni | proprietà | tecnologie |
|-----------------------|----------------|-----------|------------|
| WATER BASED TROWEL | | | |

glueflex modular big bianco



scheda
tecnica



data
sheet



ficha
técnica



| adesivo cementizio bicomponente bianco | interno esterno | two-pack ce- ment-based adhesive - white | indoor outdoor | adhesivo cementoso bicomponente blanco | interior exterior |
|---|--------------------|---|-------------------|---|----------------------|
| Adesivo cementizio bicomponente A (polvere cementizia) B (resina elasticizzante), specifico per la posa a pavimento e a parete di piastrelle ceramiche (gres porcellanato, cotto, klinker, ecc.), materiale lapideo e mosaici, non assorbenti, di grande formato. Resistenza all'umidità: ottima. Resistenza ai solventi e acidi: ottima. Per uso professionale. | | Two-pack cement-based adhesive — A (cement powder) B (elasticizing resin) — specifically formulated for laying of large, non-absorbent ceramic (porcelain stoneware, terracotta, klinker, etc.), stone and mosaic wall and floor tiles. Moisture resistance: excellent. Resistance to solvents and acids: excellent For professional use. | | Adhesivo cementoso bicomponente A (polvo de cemento) B (resina elástica), específico para la colocación en suelos y paredes de baldosas cerámicas (gres porcelánico, barro cocido, klinker, etc.), material lapídeo y mosaicos, no absorbentes, de gran formato. Resistencia a la humedad: excelente. Resistencia a los disolventes y ácidos: excelente. Para uso profesional. | |
| Granulometria: max 0,5 mm Attrezzatura: spatola dentata, cazzuola, impastatrice a basso numero di giri Rapporto di miscelazione: 30% con componente B - 7,6 kg per confezione da 25 Kg Consumo: Mosaici Piccoli formati 2 kg/m ² - standard 2,5-3,5 2 kg/m ² - Grandi 5,5-6,5 2 kg/m ² Per sistema: Termok8 Modular Big | | Particle Size: max 0.5 mm Equipment: serrated spatula, mason's trowel, low speed mixer. Mixing ratio: 30% with component B - 7.6 kg for 25 kg package Recommended use: Small mosaic tiles 2 kg/m ² - standard 2.5-3.5 2 kg/m ² - Large 5.5-6.5 2 kg/m ² For: Termok8 Modular Big system | | Granulometría: máx. 0,5 mm Herramientas: espátula dentada, paleta, amasadora de bajo número de revoluciones Relación de mezcla: 30 % con componente B - 7,6 kg por envase de 25 Kg Consumo: Mosaicos de pequeño formato 2 kg/m ² - estándar 2,5-3,5 2 kg/m ² - Grandes 5,5-6,5 2 kg/m ² Para sistema: Termok8 Modular Big | |

| tecniche | certificazioni | proprietà | tecnologie |
|-----------------------|----------------|-----------|------------|
| WATER BASED TROWEL | | | |

glueflex p

scheda
tecnicadata
sheetficha
técnica

| adesivo in pasta pronto uso | interno esterno | ready-to-use adhesive in paste form | indoor outdoor | adhesivo en pasta listo para usar | interior exterior |
|---|-----------------|--|----------------|---|-------------------|
| Adesivo in pasta specifico per l'incollaggio e la stuccatura di fughe fra rivestimenti modulari tipo Listello Flex. Ottima lavorabilità, sovraverniciabile, permeabile al vapore acqueo, colorazioni stabili, idoneo solo per lavorazioni a strato sottile. Per uso professionale | | Adhesive in paste form specific for gluing and filling joints between modular cladding, such as Flex slips. Very good workability, water vapour permeability, stable colours. Can be overpainted. Suitable only for working in thin-layers. For professional use | | Adhesivo en pasta específico para el encolado y emplaste de juntas entre revestimientos modulares tipo Listel Flex. Se trabaja con facilidad, admite recubrimiento de pintura, permeable al vapor de agua, coloraciones estables, idóneo solo para aplicaciones en capa fina. Para uso profesional. | |
| Attrezzatura: Spatola dentata con dentatura 4x4mm, 4x6mm o 5x5mm, pennello da 10mm Rapporto di miscelazione: pronto uso Consumo: 2.5-3.4 kg/m ² | | Equipment: Serrated spatula with 4x4mm, 4x6mm or 5x5mm serration, 10mm brush Mixing ratio: ready to use Recommended use: 2.5-3.4 kg/m ² | | Herramientas: Espátula dentada con dientes de 4x4 mm, 4x6 mm o 5x5 mm, brocha de 10 mm Relación de mezcla: listo para usar Consumo: 2,5-3,4 kg/m ² | |

| tecniche | certificazioni | proprietà | tecnologie |
|---|----------------|-----------|------------|
|  WATER BASED  BRUSH  TROWEL  READY TO USE | | | |

parastuck mf

scheda
tecnicadata
sheetficha
técnica

| sigillante per fughe grigio | interno esterno | joint sealant - grey | indoor outdoor | sellador para juntas gris | interior exterior |
|---|-----------------|---|----------------|--|-------------------|
| Malta cementizia, idrofugata nella massa per la stuccatura di fughe fra i listelli tipo facciavista fatti a mano in pasta "molla" su pannelli isolanti. Prodotto monocomponente, costituito da una miscela in polvere di cemento, inerti calcarei e silicei selezionati e in granulometria calibrata. Possiede ottime caratteristiche di adesione e resistenza ai cicli di gelo e disgelo. Per uso professionale. | | Cement-based mortar, waterproofed in the mass, for filling the joints of hand-made fair-faced brick slips on insulating panels. One-pack product, consisting of a powdered mixture of cement, selected calcareous and silica inert materials of calibrated particle size. They offer superb adhesion properties and resistance to freeze-thaw cycles. For professional use. | | Mortero de cemento, hidrófugo de masa para emplastar las juntas de listeles tipo facciavista hechos a mano en pasta "blanda" sobre paneles aislantes. Producto monocomponente, constituido por una mezcla en polvo de cemento, áridos silíceos y calcáreos seleccionados y en granulometría calibrada. Poseen excelentes características de adhesión y resistencia a los ciclos de hielo y deshielo. Para uso profesional. | |
| Granulometria: max 1,2 mm Attrezzatura: betoniera, spatola, impastatrice a basso numero di giri, cazzuola, ferro da giunti Rapporto di miscelazione: acqua - 17-19% Consumo: non stimabile, dipende dal listello e dalla fuga | | Particle Size: max 1.2 mm Equipment: cement mixer, spatula, low speed mixer, mason's trowel, brick jointer Mixing ratio: water - 17-19%. Recommended use: cannot be estimated, depends on the slip and joint | | Granulometría: máx. 1,2 mm Herramientas: hormigonera, espátula, amasadora de bajo número de revoluciones, paleta, hierro para juntas Relación de mezcla: agua - 17-19% Consumo: no admite estimaciones, depende del listel y de la junta | |

| tecniche | certificazioni | proprietà | tecnologie |
|--|---|-----------|------------|
|  WATER BASED  TROWEL |  | | |

parastuck

scheda
tecnicadata
sheetficha
técnica

| sigillante per fughe beige | interno esterno | joint sealant - beige | indoor outdoor | sellador para juntas beige | interior exterior |
|--|--------------------|--|-------------------|--|----------------------|
| <p>Malta cementizia, idrofugata nella massa, per la stuccatura di fughe fra i listelli tipo facciavista fatti a mano in pasta "molla" su pannelli isolanti. Prodotto monocomponente, costituito da una miscela in polvere di calce, cemento, inerti calcarei e silicei selezionati e in granulometria calibrata. Possiede ottime caratteristiche di adesione e resistenza ai cicli di gelo e disgelo. Per uso professionale.</p> | | <p>Cement-based mortar, waterproofed in the mass, for filling the joints of hand-made fair-faced brick slips on insulating panels. One-pack product, consisting of a powdered mixture of lime, cement, selected calcareous and silica inert materials of calibrated particle size. They offer superb adhesion properties and resistance to freeze-thaw cycles. For professional use.</p> | | <p>Mortero de cemento, hidrófugo de masa para emplastar las juntas de listeles tipo facciavista hechos a mano en pasta "blanda" sobre paneles aislantes. Producto monocomponente, constituido por una mezcla en polvo de cal, cemento, áridos calcáreos y silíceos seleccionados y en granulometria calibrada. Poseen excelentes características de adhesión y resistencia a los ciclos de hielo y deshielo. Para uso profesional.</p> | |
| <p>Granulometria: max 1,2 mm Attrezzatura: betoniera, spatola, impastatrice a basso numero di giri, cazzuola, ferro da giunti Rapporto di miscelazione: acqua - 17-19% Consumo: non stimabile, dipende dal listello e dalla fuga</p> | | <p>Particle Size: max 1.2 mm Equipment: cement mixer, spatula, low speed mixer, mason's trowel, brick jointer Mixing ratio: water - 17-19%. Recommended use: cannot be estimated, depends on the slip and joint</p> | | <p>Granulometría : máx. 1,2 mm Herramientas: hormigonera, espátula, amasadora de bajo número de revoluciones, paleta, hierro para juntas Relación de mezcla : agua - 17-19% Consumo: no admite estimaciones, depende del listel y de la junta</p> | |

| tecniche | | certificazioni | | | proprietà | | | | tecnologie | | | |
|--|---|---|--|--|-----------|--|--|--|------------|--|--|--|
|  |  |  | | | | | | | | | | |



converto 30-G

 scheda
tecnica

 data
sheet

 ficha
técnica

pannello in EPS additivato di grafite detensionato

Pannello isolante detensionato idoneo per l'applicazione a cappotto ETICS, realizzato in polistirene espanso sinterizzato di colore grigio. Realizzato con un contenuto di riciclato $\geq 10\%$. Omologato secondo EAD 040083-00-0404 già ETAG 004. Disponibile anche in versione fugato sagomato (fughe decorative).

Per sistema: Termok8 Grafite Plus Converto
Formato: 100 x 50 cm
Spessore: da 2 a 20 cm
Resistenza a trazione: TR ≥ 100 kPa
Classe reazione fuoco del sistema Termok8: B-s1,d0

unstressed EPS panel with the addition of graphite

Unstressed insulation panel suitable for ETICS external thermal insulation systems, made of grey sintered expanded polystyrene. Made with $\geq 10\%$ recycled content. Approved according to EAD 040083-00-0404 (formerly ETAG 004). Also available in grooved versions (decorative groovings).

For the system: Termok8 Grafite Plus Converto
Size: 100 x 50 cm
Thickness: from 2 to 20 cm
Tensile strength: TR ≥ 100 kPa
Termok8 system fire reaction class: B-s1,d0

panel en EPS destensado con aditivo de grafito

Panel aislante destensado idóneo para la aplicación por capas SATE, realizado en poliestireno expandido sinterizado de color gris. Realizado con un contenido de reciclado $\geq 10\%$. Homologado según EAD 040083-00-0404, antes ETAG 004. Disponible también en versión perfilada (con ranuras decorativas).

Para sistema: Termok8 Grafite Plus Converto
Medidas: 100 x 50 cm
Espesor: de 2 a 20 cm
Resistencia a la tracción: TR ≥ 100 kPa
Clase de reacción al fuego del sistema Termok8: B-s1,d0

tecniche



certificazioni



converto 31-G plus

 scheda
tecnica

 data
sheet

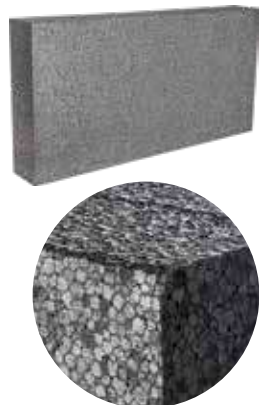
 ficha
técnica

pannello in EPS additivato di grafite detensionato

Pannello isolante detensionato idoneo per l'applicazione a cappotto ETICS, realizzato in polistirene espanso sinterizzato di colore grigio. Omologato secondo EAD 040083-00-0404 già ETAG 004. Realizzato con un contenuto di riciclato $\geq 10\%$. Disponibile anche in versione fugato sagomato (fughe decorative).

Per sistema: Termok8 Grafite Plus Converto
Formato: 100 x 50 cm
Spessore: da 2 a 20 cm
Resistenza a trazione: TR ≥ 100 kPa
Classe reazione fuoco del sistema Termok8: B-s1,d0

unstressed EPS panel with the addition of graphite

Unstressed insulation panel suitable for ETICS external thermal insulation systems, made of grey sintered expanded polystyrene. Approved according to EAD 040083-00-0404 (formerly ETAG 004). Made with $\geq 10\%$ recycled content. Also available in grooved versions (decorative groovings).

For the system: Termok8 Grafite Plus Converto
Size: 100 x 50 cm
Thickness: from 2 to 20 cm
Tensile strength: TR ≥ 100 kPa
Termok8 system fire reaction class: B-s1,d0

panel en EPS con aditivo de grafito destensado

Panel aislante destensado idóneo para la aplicación por capas SATE, realizado en poliestireno expandido sinterizado de color gris. Homologado según EAD 040083-00-0404, antes ETAG 004. Realizado con un contenido de reciclado $\geq 10\%$. Disponible también en versión perfilada (con ranuras decorativas).

Para sistema: Termok8 Grafite Plus Converto
Medidas: 100 x 50 cm
Espesor: de 2 a 20 cm
Resistencia a la tracción: TR ≥ 100 kPa
Clase de reacción al fuego del sistema Termok8: B-s1,d0

tecniche



certificazioni



converto fonostop



scheda
tecnica



data
sheet



ficha
técnica



pannello in EPS elasticizzato per un miglior isolamento acustico

Pannello isolante elasticizzato ad elevata rigidità dinamica idoneo per l'applicazione a cappotto ETICS, realizzato in polistirene espanso sinterizzato di colore grigio con zigrinatura esterna profonda 6mm. Omologato secondo EAD 040083-00-0404 già ETAG 004. Realizzato con un contenuto di riciclato $\geq 10\%$.

Per sistema: TermoK8 Fonostop Converto
Formato: 100 x 50 cm
Spessore: da 8 a 20 cm
Resistenza a trazione $TR \geq 100$ kPa
Classe reazione fuoco del sistema TermoK8: B-s1,d0

elastic EPS panel for better sound insulation

Elastic insulating panel with high dynamic stiffness, suitable for ETICS external thermal insulation systems, made of grey sintered expanded polystyrene with 6mm-deep external grooved pattern. Approved according to EAD 040083-00-0404 (formerly ETAG 004). Made with $\geq 10\%$ recycled content.

For the system: TermoK8 Fonostop Converto
Size: 100 x 50 cm
Thickness: from 8 to 20 cm
Tensile strength: $TR \geq 100$ kPa
TermoK8 system fire reaction class: B-s1,d0

panel en EPS elastizado para un mejor aislamiento acústico

Panel aislante elastizado de elevada rigidez dinámica idóneo para la aplicación por capas SATE, realizado en poliestireno expandido sinterizado de color gris con moleteado externo de 6 mm de profundidad. Homologado según EAD 040083-00-0404, antes ETAG 004. Realizado con un contenido de reciclado $\geq 10\%$.

Para sistema: TermoK8 Fonostop Converto
Medidas: 100 x 50 cm
Espesor: de 8 a 20 cm
Resistencia a la tracción: $TR \geq 100$ kPa
Clase de reacción al fuego del sistema TermoK8: B-s1,d0

tecniche



certificazioni



converto HP



scheda
tecnica



data
sheet



ficha
técnica

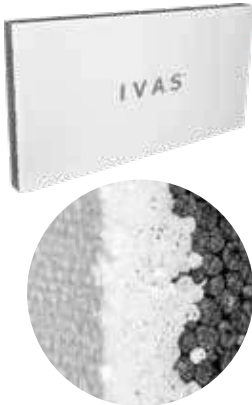

pannello in EPS sintolaminato

Pannello isolante sintolaminato idoneo per l'applicazione a cappotto ETICS, realizzato in polistirene espanso sinterizzato additivato con oltre il 70% di grafite e con strato esterno in EPS bianco per minimizzare gli effetti dell'irraggiamento. Omologato secondo EAD 040083-00-0404 già ETAG 004. Realizzato con un contenuto di riciclato $\geq 15\%$.

Per sistema: TermoK8 HP Converto
Formato: 120 x 60 cm
Spessore: da 6 a 22 cm
Resistenza a trazione $TR \geq 150$ kPa
Classe reazione fuoco del sistema TermoK8: B-s1,d0

EPS panel produced by lamination synthesis

Insulating panel produced by lamination synthesis, suitable for ETICS external thermal insulation systems, made of sintered expanded polystyrene with the addition of over 70% graphite and with white EPS outer layer to minimise the effects of radiation. Approved according to EAD 040083-00-0404 (formerly ETAG 004). Made with $\geq 15\%$ recycled content.

For the system: TermoK8 HP Converto
Size: 120 x 60 cm
Thickness: from 6 to 22 cm
Tensile strength: $TR \geq 150$ kPa
TermoK8 system fire reaction class: B-s1,d0

panel en EPS sintolaminado

Panel aislante sintolaminado idóneo para la aplicación por capas SATE, realizado en poliestireno expandido sinterizado aditivado con más del 70 % de grafito y con capa externa de EPS blanco para reducir al mínimo los efectos de la radiación solar. Homologado según EAD 040083-00-0404, antes ETAG 004. Realizado con un contenido de reciclado $\geq 15\%$.

Para sistema: TermoK8 HP Converto
Medidas: 120 x 60 cm
Espesor: de 6 a 22 cm
Resistencia a la tracción: $TR \geq 150$ kPa
Clase de reacción al fuego del sistema TermoK8: B-s1,d0

tecniche



certificazioni



converto 35-100

 scheda
tecnica

 data
sheet

 ficha
técnica

| pannello in EPS bianco | EPS panel - white | panel en EPS blanco |
|--|---|--|
| <p>Pannello isolante idoneo per l'applicazione a cappotto ETICS, realizzato in polistirene espanso sinterizzato di colore bianco. Omologato secondo EAD 040083-00-0404 già ETAG 004. Realizzato con un contenuto di riciclato $\geq 10\%$. Disponibile anche in versione fugato sagomato (fughe decorative).</p> | <p>Insulation panel suitable for ETICS external thermal insulation systems, made of white sintered expanded polystyrene. Approved according to EAD 040083-00-0404 (formerly ETAG 004). Made with $\geq 10\%$ recycled content. Also available in grooved versions (decorative groovings).</p> | <p>Panel aislante idóneo para la aplicación por capas SATE, realizado en poliestireno expandido sinterizado de color blanco. Homologado según EAD 040083-00-0404, antes ETAG 004. Realizado con un contenido de reciclado $\geq 10\%$. Disponible también en versión perfilada (con ranuras decorativas).</p> |
| <p>Per sistema: Termok8 Classico Converto Formato: 100 x 50 cm Spessore: da 2 a 20 cm Resistenza a trazione: TR ≥ 150 kPa Resistenza a compressione CS(10) ≥ 100 kPa Classe reazione fuoco del sistema Termok8: B-s1,d0</p> | <p>For the system: Termok8 Classico Converto Size: 100 x 50 cm Thickness: from 2 to 20 cm Tensile strength: TR ≥ 150 kPa Compressive strength: CS(10) ≥ 100 kPa Termok8 system fire reaction class: B-s1,d0</p> | <p>Para sistema: Termok8 Classico Converto Medidas: 100 x 50 cm Espeor: de 2 a 20 cm Resistencia a la tracción: TR ≥ 150 kPa Resistencia a la compresión CS(10) ≥ 100 kPa Clase de reacción al fuego del sistema Termok8: B-s1,d0</p> |

tecniche



certificazioni



converto P 200

 scheda
tecnica

 data
sheet

 ficha
técnica

| pannello in EPS a basso assorbimento d'acqua | EPS panel with low water absorption | panel en EPS de baja absorción de agua |
|---|---|--|
| <p>Pannello isolante idoneo per l'applicazione a cappotto ETICS, realizzato in polistirene espanso sinterizzato di colore azzurro a basso assorbimento capillare d'acqua, per le zone perimetrali di zoccolatura. Omologato secondo EAD 040083-00-0404 già ETAG 004. Realizzato con un contenuto di riciclato $\geq 10\%$.</p> | <p>Insulation panel suitable for ETICS external thermal insulation systems, made of light blue sintered expanded polystyrene with low capillary water absorption, designed for building plinth areas. Approved according to EAD 040083-00-0404 (formerly ETAG 004). Made with $\geq 10\%$ recycled content.</p> | <p>Panel aislante idóneo para la aplicación por capas ETICS, realizado en poliestireno expandido sinterizado de color celeste con baja absorción capilar de agua, para las zonas perimetrales de rodapié. Homologado según EAD 040083-00-0404, antes ETAG 004. Realizado con un contenido de reciclado $\geq 10\%$.</p> |
| <p>Per sistema: per le fasce di zoccolatura di tutti i sistemi Termok8 Formato: 100 x 50 cm Spessore: da 4 a 20 cm Resistenza a trazione: TR ≥ 150 kPa Resistenza a compressione CS(10) ≥ 150 kPa Classe reazione fuoco del sistema Termok8: B-s1,d0</p> | <p>For the system: for the plinth areas of all Termok8 systems Size: 100 x 50 cm Thickness: from 4 to 20 cm Tensile strength: TR ≥ 150 kPa Compressive strength: CS(10) ≥ 150 kPa Termok8 system fire reaction class: B-s1,d0</p> | <p>Para sistema: para las franjas de rodapié de todos los sistemas Termok8 Medidas: 100 x 50 cm Espeor: de 4 a 20 cm Resistencia a la tracción: TR ≥ 150 kPa Resistencia a la compresión CS(10) ≥ 150 kPa Clase de reacción al fuego del sistema Termok8: B-s1,d0</p> |

tecniche



certificazioni





converto 30 BW

 scheda
tecnica

 data
sheet

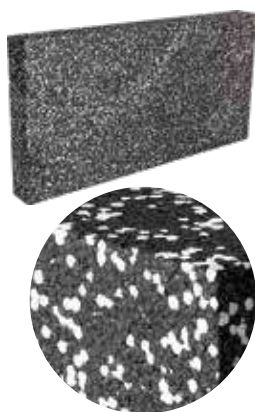
 ficha
técnica

pannello in EPS additivato di grafite al 70% detensionato

Pannello isolante detensionato idoneo per l'applicazione a cappotto ETICS, realizzato in polistirene espanso sinterizzato di colore grigio/bianco. Omologato secondo EAD 040083-00-0404 già ETAG 004. Realizzato con un contenuto di riciclato $\geq 10\%$. Disponibile anche in versione fugato sagomato (fughe decorative).

Per sistema: Termok8 BW Converto
Formato: 100 x 50 cm
Spessore: da 2 a 20 cm
Resistenza a trazione: TR ≥ 140 kPa
Classe reazione fuoco del sistema Termok8: B-s1,d0

unstressed EPS panel with the addition of 70% graphite

Unstressed insulation panel suitable for ETICS external thermal insulation systems, made of grey/white sintered expanded polystyrene. Approved according to EAD 040083-00-0404 (formerly ETAG 004). Made with $\geq 10\%$ recycled content. Also available in grooved versions (decorative groovings).

For the system: Termok8 BW Converto
Size: 100 x 50 cm
Thickness: from 2 to 20 cm
Tensile strength: TR ≥ 140 kPa
Termok8 system fire reaction class: B-s1,d0

panel en EPS aditivado con grafito al 70 % destensado

Panel aislante destensado idóneo para la aplicación por capas SATE, realizado en poliestireno expandido sinterizado de color gris/blanco, homologado según EAD 040083-00-0404, antes ETAG 004. Realizado con un contenido de reciclado $\geq 10\%$. Disponible también en versión perfilada (con ranuras decorativas).

Para sistema: Termok8 BW Converto
Medidas: 100 x 50 cm
Espesor: de 2 a 20 cm
Resistencia a la tracción: TR ≥ 140 kPa
Clase de reacción al fuego del sistema Termok8: B-s1,d0

tecniche



certificazioni



converto 31 BW

 scheda
tecnica

 data
sheet

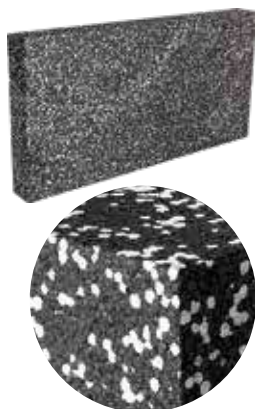
 ficha
técnica

pannello in EPS additivato di grafite detensionato

Pannello isolante detensionato idoneo per l'applicazione a cappotto ETICS, realizzato in polistirene espanso sinterizzato di colore grigio/bianco. Omologato secondo EAD 040083-00-0404 già ETAG 004. Realizzato con un contenuto di riciclato $\geq 15\%$. Disponibile anche in versione fugato sagomato (fughe decorative).

Per sistema: Termok8 BW Converto
Formato: 100 x 50 cm
Spessore: da 2 a 20 cm
Resistenza a trazione: TR ≥ 150 kPa
Classe reazione fuoco del sistema Termok8: B-s1,d0

unstressed EPS panel with the addition of graphite

Unstressed insulation panel suitable for ETICS external thermal insulation systems, made of grey/white sintered expanded polystyrene. Approved according to EAD 040083-00-0404 (formerly ETAG 004). Made with $\geq 15\%$ recycled content. Also available in grooved versions (decorative groovings).

For the system: Termok8 BW Converto
Size: 100 x 50 cm
Thickness: from 2 to 20 cm
Tensile strength: TR ≥ 150 kPa
Termok8 system fire reaction class: B-s1,d0

panel en EPS con aditivo de grafito destensado

Panel aislante destensado idóneo para la aplicación por capas SATE, realizado en poliestireno expandido sinterizado de color gris/blanco. Homologado según EAD 040083-00-0404, antes ETAG 004. Realizado con un contenido de reciclado $\geq 15\%$. Disponible también en versión perfilada (con ranuras decorativas).

Para sistema: Termok8 BW Converto
Medidas: 100 x 50 cm
Espesor: de 2 a 20 cm
Resistencia a la tracción: TR ≥ 150 kPa
Clase de reacción al fuego del sistema Termok8: B-s1,d0

tecniche



certificazioni



converto 34 BW



scheda
tecnica



data
sheet



ficha
técnica

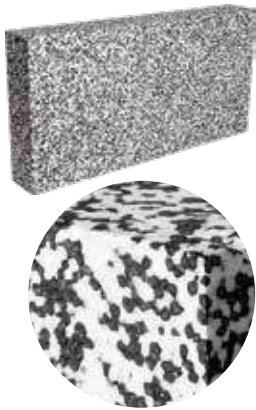

| | | |
|--|--|---|
| <p>pannello in EPS additivato di grafite</p> <p>Pannello isolante detensionato idoneo per l'applicazione a cappotto ETICS, realizzato in polistirene espanso sinterizzato di colore bianco/grigio. Omologato secondo EAD 040083-00-0404 già ETAG 004. Realizzato con un contenuto di riciclato $\geq 10\%$. Disponibile anche in versione fugato sagomato (fughe decorative).</p> <p>Per sistema: Termok8 BW Converto Formato: 100 x 50 cm Spessore: da 2 a 20 cm Resistenza a trazione TR ≥ 100 kPa Classe reazione fuoco del sistema Termok8: B-s1,d0</p> | <p>EPS panel with the addition of graphite</p> <p>Unstressed insulation panel suitable for ETICS external thermal insulation systems, made of white/grey sintered expanded polystyrene. Approved according to EAD 040083-00-0404 (formerly ETAG 004). Made with $\geq 10\%$ recycled content. Also available in grooved versions (decorative groovings).</p> <p>For the system: Termok8 BW Converto Size: 100 x 50 cm Thickness: from 2 to 20 cm Tensile strength: TR ≥ 100 kPa Termok8 system fire reaction class: B-s1,d0</p> | <p>panel en EPS con aditivo de grafito</p> <p>Panel aislante destensado idóneo para la aplicación por capas SATE, realizado en poliestireno expandido sinterizado de color blanco/gris. Homologado según EAD 040083-00-0404, antes ETAG 004. Realizado con un contenido de reciclado $\geq 10\%$. Disponible también en versión perfilada (con ranuras decorativas).</p> <p>Para sistema: Termok8 BW Converto Medidas: 100 x 50 cm Espesor: de 2 a 20 cm Resistencia a la tracción: TR ≥ 100 kPa Clase de reacción al fuego del sistema Termok8: B-s1,d0</p> |
|--|--|---|

tecniche



certificazioni



eps 35 max R

 scheda
tecnica

 data
sheet

 ficha
técnica

pannello in EPS per una maggiore resistenza agli urti

Pannello isolante detensionato idoneo per l'applicazione a cappotto ETICS, realizzato in polistirene espanso sinterizzato con zigrinatura esterna per migliorare la resistenza agli urti del sistema ≥ 20 J e 60 J. Omologato secondo EAD 040083-00-0404 già ETAG 004. Realizzato con un contenuto di riciclato $\geq 15\%$.

Per sistemi: Termok8 A.R. Max 20 J e Termok8 A.R. Max 60 J
Formato: 100 x 50 cm
Spessore: da 4 a 20 cm
Resistenza a trazione TR ≥ 150 kPa
Classe reazione fuoco del sistema
Termok8: B-s1,d0

EPS panel for increased impact resistance

Unstressed insulation panel suitable for ETICS external thermal insulation systems, made of sintered expanded polystyrene with external grooved pattern to improve system impact resistance ≥ 20 J and 60 J. Approved according to EAD 040083-00-0404 (formerly ETAG 004). Made with $\geq 15\%$ recycled content.

For the systems: Termok8 A.R. Max 20 J and Termok8 A.R. Max 60 J
Size: 100 x 50 cm
Thickness: from 4 to 20 cm
Tensile strength: TR ≥ 150 kPa
Termok8 system fire reaction class:
B-s1,d0

panel en EPS para una mayor resistencia a los golpes

Panel aislante destensado idóneo para la aplicación por capas SATE, realizado en poliestireno expandido sinterizado, con moleteado externo para mejorar la resistencia a los golpes del sistema ≥ 20 J y 60 J. Homologado según EAD 040083-00-0404, antes ETAG 004. Realizado con un contenido de reciclado $\geq 15\%$.

Para sistemas: Termok8 A.R. Máx 20 J y Termok8 A.R. Máx 60 J
Medidas: 100 x 50 cm
Espesor: de 4 a 20 cm
Resistencia a la tracción: TR ≥ 150 kPa
Clase de reacción al fuego del sistema
Termok8: B-s1,d0

tecniche



certificazioni



eps 35-100 fix R

 scheda
tecnica

 data
sheet

 ficha
técnica

pannello in EPS per sistemi modulari

Pannello isolante idoneo per l'applicazione a cappotto ETICS, realizzato in polistirene espanso sinterizzato di colore bianco con zigrinatura su entrambi i lati e, sulla superficie esterna, quattro scassi trasversali ribassati. Realizzato con un contenuto di riciclato $\geq 10\%$.

Per sistemi: Termok8 Modular Design
Formato: 100 x 50 cm
Spessore: da 4 a 20 cm
Resistenza a trazione TR ≥ 150 kPa
Resistenza a compressione CS(10) ≥ 100 kPa
Classe reazione fuoco del sistema
Termok8: B-s1,d0

EPS panel for modular systems

Insulation panel suitable for ETICS external thermal insulation systems, made of white sintered expanded polystyrene with grooved pattern on both sides and four deep transversal grooves on the external surface. Made with $\geq 10\%$ recycled content.

For the systems: Termok8 Modular Design
Size: 100 x 50 cm
Thickness: from 4 to 20 cm
Tensile strength: TR ≥ 150 kPa
Compressive strength: CS(10) ≥ 100 kPa
Termok8 system fire reaction class:
B-s1,d0

panel en EPS para sistemas modulares

Panel aislante idóneo para la aplicación por capas SATE, realizado en poliestireno expandido sinterizado de color blanco con moleteado en los dos lados y cuatro cavidades transversales rebajadas en la superficie externa. Realizado con un contenido de reciclado $\geq 10\%$.

Para sistemas: Termok8 Modular Design
Medidas: 100 x 50 cm
Espesor: de 4 a 20 cm
Resistencia a la tracción: TR ≥ 150 kPa
Resistencia a la compresión CS(10) ≥ 100 kPa
Clase de reacción al fuego del sistema
Termok8: B-s1,d0

tecniche



certificazioni



eps meccanico R

 scheda
tecnica

 data
sheet

 ficha
técnica

pannello in EPS per supporti difficili

Pannello isolante idoneo per l'applicazione a cappotto ETICS, realizzato in polistirene espanso sinterizzato di colore bianco, fresato lungo i quattro lati con un'opportuna scanalatura per il fissaggio dei profili del sistema meccanico. Realizzato con un contenuto di riciclato $\geq 15\%$.

Per sistema: Termok8 Meccanico
Formato: 60 x 60 cm
Spessore: da 5 a 20 cm
Resistenza a trazione TR ≥ 200 kPa
Classe reazione fuoco del sistema
Termok8: B-s2,d0

EPS panel for difficult substrates

Insulation panel suitable for ETICS external thermal insulation systems, made of white sintered expanded polystyrene with grooves cut into all four sides to fasten the mechanical system profiles. Made with $\geq 15\%$ recycled content.

For the system: Termok8 Meccanico
Size: 60 x 60 cm
Thickness: from 5 to 20 cm
Tensile strength: TR ≥ 200 kPa
Termok8 system fire reaction class:
B-s2,d0

panel en EPS para soportes difíciles

Panel aislante idóneo para la aplicación por capas SATE, realizado en poliestireno expandido sinterizado de color blanco, frendimentado a lo largo de los cuatro lados con una ranura para la fijación de los perfiles del sistema mecánico. Realizado con un contenido de reciclado $\geq 15\%$.

Para sistema: Termok8 Meccanico
Medidas: 60 x 60 cm
Espesor: de 5 a 20 cm
Resistencia a la tracción: TR ≥ 200 kPa
Clase de reacción al fuego del sistema
Termok8: B-s2,d0

tecniche



certificazioni



eps 31-G max R



scheda
tecnica



data
sheet



ficha
técnica

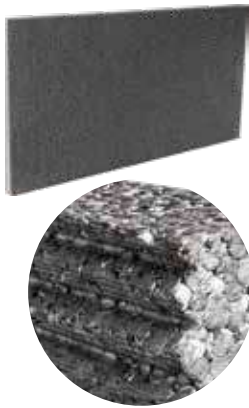

| | | |
|---|---|---|
| <p>pannello in EPS additivato di grafite</p> <p>Pannello isolante detensionato idoneo per l'applicazione a cappotto ETICS, realizzato in polistirene espanso sinterizzato di colore grigio con zigrinatura esterna per migliorare la resistenza agli urti del sistema ≥ 20 J e 60 J. Omologato secondo EAD 040083-00-0404 già ETAG 004. Realizzato con un contenuto di riciclato $\geq 15\%$.</p> <p>Per sistemi: TermoK8 A.R. Max 20 J e TermoK8 A.R. Max 60 J Formato: 100 x 50 cm Spessore: da 4 a 20 cm Resistenza a trazione TR ≥ 120 kPa Classe reazione fuoco del sistema TermoK8: B-s1,d0</p> | <p>EPS panel with the addition of graphite</p> <p>Unstressed insulation panel suitable for ETICS external thermal insulation systems, made of grey sintered expanded polystyrene with external grooved pattern to improve system impact resistance ≥ 20 J and 60 J. Approved according to EAD 040083-00-0404 (formerly ETAG 004). Made with $\geq 15\%$ recycled content.</p> <p>For the systems: TermoK8 A.R. Max 20 J and TermoK8 A.R. Max 60 J Size: 100 x 50 cm Thickness: from 4 to 20 cm Tensile strength: TR ≥ 120 kPa TermoK8 system fire reaction class: B-s1,d0</p> | <p>panel en EPS con aditivo de grafito</p> <p>Panel aislante destensado idóneo para la aplicación por capas SATE, realizado en poliestireno expandido sinterizado de color gris con moleteado externo para mejorar la resistencia a los golpes del sistema ≥ 20 J y 60 J. Homologado según EAD 040083-00-0404 antes ETAG 004. Realizado con un contenido de reciclado $\geq 15\%$.</p> <p>Para sistemas: TermoK8 A.R. Máx 20 J y TermoK8 A.R. Max 60 J Medidas: 100 x 50 cm Espesor: de 4 a 20 cm Resistencia a la tracción: TR ≥ 120 kPa Clase de reacción al fuego del sistema TermoK8: B-s1,d0</p> |
|---|---|---|

tecniche



certificazioni



eps 31-G 100 fix R



scheda
tecnica



data
sheet



ficha
técnica

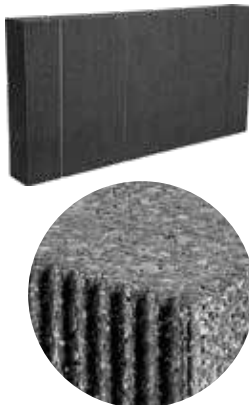

| | | |
|---|---|---|
| <p>pannello in EPS additivato di grafite per sistemi modulari</p> <p>Pannello isolante idoneo per l'applicazione a cappotto ETICS, realizzato in polistirene espanso sinterizzato di colore grigio con zigrinatura su entrambi i lati e, sulla superficie esterna, quattro scassi trasversali ribassati. Realizzato con un contenuto di riciclato $\geq 10\%$.</p> <p>Per sistemi: TermoK8 Modular Design Formato: 100 x 50 cm Spessore: da 4 a 20 cm Resistenza a trazione TR ≥ 150 kPa Resistenza a compressione CS(10) ≥ 100 kPa Classe reazione fuoco del sistema TermoK8: B-s1,d0</p> | <p>unstressed EPS panel with the addition of graphite</p> <p>Insulation panel suitable for ETICS external thermal insulation systems, made of grey sintered expanded polystyrene with grooved pattern on both sides and four deep transversal grooves on the external surface. Made with $\geq 10\%$ recycled content.</p> <p>For the systems: TermoK8 Modular Design Size: 100 x 50 cm Thickness: from 4 to 20 cm Tensile strength: TR ≥ 150 kPa Compressive strength: CS(10) ≥ 100 kPa TermoK8 system fire reaction class: B-s1,d0</p> | <p>panel en EPS con aditivo de grafito destensado</p> <p>Panel aislante idóneo para la aplicación por capas SATE, realizado en poliestireno expandido sinterizado de color gris con moleteado en los dos lados y cuatro cavidades transversales rebajadas en la superficie externa. Con contenido de reciclado $\geq 10\%$.</p> <p>Para sistemas: TermoK8 Modular Design Medidas: 100 x 50 cm Espesor: de 4 a 20 cm Resistencia a la tracción: TR ≥ 150 kPa Resistencia a la compresión CS(10) ≥ 100 kPa Clase de reacción al fuego del sistema TermoK8: B-s1,d0</p> |
|---|---|---|

tecniche



certificazioni



eps G meccanico R



scheda
tecnica



data
sheet



ficha
técnica

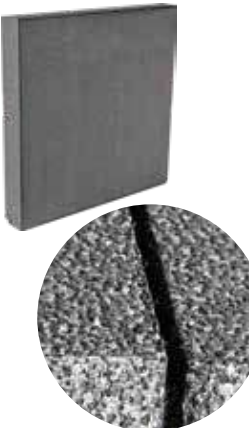

| | | |
|--|--|--|
| <p>pannello in EPS additivato di grafite per supporti difficili</p> <p>Pannello isolante idoneo per l'applicazione a cappotto ETICS, realizzato in polistirene espanso sinterizzato di colore grigio, fresato lungo i quattro lati con un'opportuna scanalatura per il fissaggio dei profili del sistema meccanico. Realizzato con un contenuto di riciclato $\geq 15\%$.</p> <p>Per sistema: TermoK8 Meccanico Formato: 60 x 60 cm Spessore: da 5 a 20 cm Resistenza a trazione TR ≥ 150 kPa Classe reazione fuoco del sistema TermoK8: B-s2,d0</p> | <p>EPS panel with the addition of graphite for difficult substrates</p> <p>Insulation panel suitable for ETICS external thermal insulation systems, made of grey sintered expanded polystyrene with grooves cut into all four sides to fasten the profiles of the mechanical system. Made with $\geq 15\%$ recycled content.</p> <p>For the system: TermoK8 Meccanico Size: 60 x 60 cm Thickness: from 5 to 20 cm Tensile strength: TR ≥ 150 kPa TermoK8 system fire reaction class: B-s2,d0</p> | <p>panel en EPS con aditivo de grafito para soportes difíciles</p> <p>Panel aislante idóneo para la aplicación por capas SATE, realizado en poliestireno expandido sinterizado de color gris, fResidamiento a lo largo de los cuatro lados con una ranura para la fijación de los perfiles del sistema mecánico. Realizado con un contenido de reciclado $\geq 15\%$.</p> <p>Para sistema: TermoK8 Meccanico Medidas: 60 x 60 cm Espesor: de 5 a 20 cm Resistencia a la tracción: TR ≥ 150 kPa Clase de reacción al fuego del sistema TermoK8: B-s2,d0</p> |
|--|--|--|

tecniche



certificazioni



converto P 200 HP



scheda
tecnica



data
sheet



ficha
técnica



pannello in EPS sintolaminato a basso assorbimento d'acqua

Pannello isolante idoneo per l'applicazione a cappotto ETICS, realizzato in polistirene espanso sinterizzato additivato con oltre il 70% di grafite, e con strato esterno in EPS di colore azzurro, a basso assorbimento capillare d'acqua, per le zone perimetrali di zoccolatura. Omologato secondo EAD 040083-00-0404 già ETAG 004. Realizzato con un contenuto di riciclato \geq 15%.

Per le fasce di zoccolatura di tutti i sistema Termok8

Formato: 120 x 60 cm

Spessore: da 6 a 20 cm

Resistenza a trazione TR \geq 150 kPa

Classe reazione fuoco del sistema Termok8: B-s1,d0

EPS panel produced by lamination synthesis with low water absorption

Insulation panel suitable for ETICS external thermal insulation systems, made of sintered expanded polystyrene with the addition of over 70% graphite and external surface in light blue EPS. Offers low capillary water absorption, designed for building plinth areas. Approved according to EAD 040083-00-0404 (formerly ETAG 004). Made with \geq 15% recycled content.

For the plinth areas of all Termok8 systems

Size: 120 x 60 cm

Thickness: from 6 to 20 cm

Tensile strength: TR \geq 150 kPa

Termok8 system fire reaction class:

B-s1,d0

panel en EPS sintolaminado de baja absorción de agua

Panel aislante idóneo para la aplicación por capas SATE, realizado en poliestireno expandido sinterizado aditivado con más del 70 % de grafito, y con una capa externa en EPS de color celeste, de baja absorción capilar de agua, para las zonas perimetrales de rodapié. Homologado según EAD 040083-00-0404, antes ETAG 004. Realizado con un contenido de reciclado \geq 15%.

Para las franjas de rodapié de todos los sistemas Termok8

Medidas: 120 x 60 cm

Espesor: de 6 a 20 cm

Resistencia a la tracción: TR \geq 150 kPa

Clase de reacción al fuego del sistema

Termok8: B-s1,d0

tecniche



certificazioni



reverso



scheda
tecnica



data
sheet



ficha
técnica



pannello in EPS sintolaminato 100% riciclato

Pannello isolante idoneo per l'applicazione a cappotto ETICS, realizzato in polistirene espanso sinterizzato additivato con oltre il 70% di grafite e con strato esterno in EPS verde con contenuto di materiale riciclato al 100% derivato da materie prime rinnovabili secondo il metodo Biomass Balance certificato Bureau Veritas al disciplinare tecnico Remade in Italy. Omologato secondo EAD 040083-00-0404 già ETAG 004.

Per sistema: Termok8 HP green

Formato: 120 x 60 cm

Spessore: da 6 a 22 cm

Resistenza a trazione TR \geq 150 kPa

Classe reazione fuoco del sistema

Termok8: B-s1,d0

100% recycled EPS panel produced by lamination synthesis

Insulating panel suitable for ETICS external thermal insulation systems, made of sintered expanded polystyrene with the addition of over 70% graphite and external surface in green EPS with 100% recycled content derived entirely from renewable raw materials according to the Biomass Balance method certified by Bureau Veritas and Remade in Italy technical specifications. Approved according to EAD 040083-00-0404 (formerly ETAG 004).

For the system: Termok8 HP green

Size: 120 x 60 cm

Thickness: from 6 to 22 cm

Tensile strength: TR \geq 150 kPa

Termok8 system fire reaction class:

B-s1,d0

panel en EPS sintolaminado 100 % reciclado

Panel aislante idóneo para la aplicación por capas SATE, realizado en poliestireno expandido sinterizado aditivado con más del 70 % de grafito y con capa externa de EPS verde con contenido de material reciclado al 100 % derivado de materias primas renovables según el método Biomass Balance certificado Bureau Veritas según el pliego de especificaciones técnicas Remade in Italy. Homologado según EAD 040083-00-0404, antes ETAG 004.

Para sistema: Termok8 HP green

Medidas: 120 x 60 cm

Espesor: de 6 a 22 cm

Resistencia a la tracción: TR \geq 150 kPa

Clase de reacción al fuego del sistema

Termok8: B-s1,d0

tecniche



certificazioni





eps 35 plus

scheda
tecnicadata
sheetficha
técnica

| pannello in EPS bianco detensionato | unstressed EPS panel - white | panel en EPS blanco destensado |
|--|---|---|
| Pannello isolante detensionato idoneo per l'applicazione a cappotto ETICS, realizzato in polistirene espanso sinterizzato di colore bianco. Omologato secondo EAD 040083-00-0404 già ETAG 004. Disponibile anche in versione fugato sagomato (fughe decorative) | Unstressed insulation panel suitable for ETICS external thermal insulation systems, made of white sintered expanded polystyrene. Approved according to EAD 040083-00-0404 (formerly ETAG 004). Also available in grooved versions (decorative groovings). | Panel aislante destensado idóneo para la aplicación por capas SATE, realizado en poliestireno expandido sinterizado de color blanco. Homologado según EAD 040083-00-0404, antes ETAG 004. Disponible también en versión para juntas perfiladas (juntas decorativas) |
| Per sistema: Termok8 Classico 35 Plus Formato: 100 x 50 cm Spessore: da 2 a 20 cm Resistenza a trazione TR ≥ 150 kPa Classe reazione fuoco del sistema Termok8: B-s1,d0 | For the system: Termok8 Classico 35 Plus Size: 100 x 50 cm Thickness: from 2 to 20 cm Tensile strength: TR ≥ 150 kPa Termok8 system fire reaction class: B-s1,d0 | Para sistema: Termok8 Classico 35 Plus Medidas: 100 x 50 cm Espesor: de 2 a 20 cm Resistencia a la tracción: TR ≥ 150 kPa Clase de reacción al fuego del sistema Termok8: B-s1,d0 |

tecniche



certificazioni





lana di roccia monodensità



scheda
tecnica



data
sheet



ficha
técnica



pannello in lana di roccia monodensità

Pannello isolante in lana minerale di roccia (MW) idoneo per l'applicazione a cappotto ETICS, biosolubile, incombustibile, con elevate prestazioni di isolamento termico, acustico e con elevata diffusività al vapore. Omologato secondo EAD 040083-00-0404 già ETAG 004. Fornibile su richiesta nella versione con primer ai silicati di calcio su un lato per facilitare la posa della rasatura. Su ordinazione sono disponibili pannelli con $\lambda = 0,035 \text{ W/m}\cdot\text{K}$ e $\lambda = 0,036 \text{ W/m}\cdot\text{K}$

Per i sistemi: Termok8 Minerale L.R. e Termok8 Modular Flex L.R.
Formato: 100 x 60 cm
Spessore: da 6 a 20 cm
Resistenza a trazione $\text{TR} \geq 7,5 \text{ kPa}$
Classe reazione fuoco del sistema
Termok8: A2-s1,d0

single-density rock wool panel

Rock mineral wool insulation panel (MW) suitable for ETICS external thermal insulation systems. Biosoluble, non-combustible, provides high thermal and acoustic insulation performance and high vapour diffusivity. Approved according to EAD 040083-00-0404 (formerly ETAG 004). Upon request, can be supplied with calcium silicate primer on one side to facilitate application of the skim coat. Panels with $\lambda = 0,035 \text{ W/m}\cdot\text{K}$ and $\lambda = 0,036 \text{ W/m}\cdot\text{K}$ available upon request.

For the systems: Termok8 Minerale L.R. and Termok8 Modular Flex L.R.
Size: 100 x 60 cm
Thickness: from 6 to 20 cm
Tensile strength: $\text{TR} \geq 7,5 \text{ kPa}$
Termok8 system fire reaction class: A2-s1,d0

panel en lana de roca monodensidad

Panel aislante en lana mineral de roca (MW) idóneo para la aplicación por capas SATE, biosoluble, incombustible, con altas prestaciones de aislamiento térmico, acústico y con gran capacidad de difusión del vapor. Homologado según EAD 040083-00-0404, antes ETAG 004. Bajo pedido puede suministrarse en la versión con imprimación de silicatos de calcio por un lado para facilitar la aplicación del enrasado. Bajo pedido hay disponibles paneles con $\lambda = 0,035 \text{ W/m}\cdot\text{K}$ y $\lambda = 0,036 \text{ W/m}\cdot\text{K}$

Para sistemas: Termok8 Minerale L.R. y Termok8 Modular Flex L.R.
Medidas: 100 x 60 cm
Espesor: de 6 a 20 cm
Resistencia a la tracción: $\text{TR} \geq 7,5 \text{ kPa}$
Clase de reacción al fuego del sistema
Termok8: A2-s1,d0

tecniche



certificazioni



lana di roccia doppia densità



scheda
tecnica



data
sheet



ficha
técnica



pannello in lana di roccia a doppia densità

Pannello isolante in lana minerale di roccia (MW) idoneo per l'applicazione a cappotto ETICS, biosolubile, incombustibile, con elevate prestazioni di isolamento termico, acustico e con elevata diffusività al vapore. Omologato secondo EAD 040083-00-0404 già ETAG 004.

Per i sistemi: Termok8 Minerale L.R. e Termok8 Modular Flex L.R.
Formato: 120 x 60 cm
Spessore: da 6 a 20 cm
Resistenza a trazione $\text{TR} \geq 7,5 \text{ kPa}$
Classe reazione fuoco del sistema
Termok8: A2-s1,d0

double-density rock wool panel

Mineral rock wool insulation panel (MW) suitable for ETICS external thermal insulation systems. Biosoluble, non-combustible, provides high thermal and acoustic insulation performance and high vapour diffusivity. Approved according to EAD 040083-00-0404 (formerly ETAG 004).

For the systems: Termok8 Minerale L.R. and Termok8 Modular Flex L.R.
Size: 120 x 60 cm
Thickness: from 6 to 20 cm
Tensile strength: $\text{TR} \geq 7,5 \text{ kPa}$
Termok8 system fire reaction class: A2-s1,d0

panel en lana de roca de doble densidad

Panel aislante en lana mineral de roca (MW) idóneo para la aplicación por capas SATE, biosoluble, incombustible, con altas prestaciones de aislamiento térmico, acústico y con gran capacidad de difusión del vapor. Homologado según EAD 040083-00-0404, antes ETAG 004.

Para sistemas: Termok8 Minerale L.R. y Termok8 Modular Flex L.R.
Medidas: 120 x 60 cm
Espesor: de 6 a 20 cm
Resistencia a la tracción: $\text{TR} \geq 7,5 \text{ kPa}$
Clase de reacción al fuego del sistema
Termok8: A2-s1,d0

tecniche



certificazioni



lana di vetro k34



scheda
tecnica



data
sheet



ficha
técnica



| pannello in lana di vetro | glass fibre panel | panel en lana de vidrio |
|--|--|--|
| <p>Pannello isolante in lana minerale di vetro (MW) idoneo per l'applicazione a cappotto ETICS, biosolubile, incombustibile, con elevate prestazioni di isolamento termico, acustico e con elevata diffusività al vapore. Prodotto in Italia con almeno l'80% di vetro riciclato. Omologato secondo EAD 040083-00-0404 già ETAG 004.</p> | <p>Mineral glass fibre insulation panel (MW) suitable for ETICS external thermal insulation systems. Biosoluble, non-combustible, provides high thermal and acoustic insulation performance and high vapour diffusivity. Made in Italy with at least 80% recycled glass. Approved according to EAD 040083-00-0404 (formerly ETAG 004).</p> | <p>Panel aislante en lana mineral de vidrio (MW) idóneo para la aplicación por capas SATE, biosoluble, incombustible, con altas prestaciones de aislamiento térmico, acústico y con gran capacidad de difusión del vapor. Producido en Italia con un mínimo del 80 % de vidrio reciclado. Homologado según EAD 040083-00-0404, antes ETAG 004.</p> |
| <p>Per sistema: TermoK8 Minerale L.V. Formato: 120 x 60 cm Spessore: da 6 a 20 cm Resistenza a trazione TR ≥ 7,5 kPa Classe reazione fuoco del sistema TermoK8: A2-s1,d0</p> | <p>For the system: TermoK8 Minerale L.V. Size: 120 x 60 cm Thickness: from 6 to 20 cm Tensile strength: TR ≥ 7,5 kPa TermoK8 system fire reaction class: A2-s1,d0</p> | <p>Para sistema: TermoK8 Minerale L.V. Medidas: 120 x 60 cm Espesor: de 6 a 20 cm Resistencia a la tracción: TR ≥ 7,5 kPa Clase de reacción al fuego del sistema TermoK8: A2-s1,d0</p> |

tecniche



certificazioni



multipor



scheda
tecnica



data
sheet



ficha
técnica



| pannello minerale | mineral panel | panel mineral |
|---|--|--|
| <p>Pannello isolante minerale idoneo per l'applicazione a cappotto ETICS, a base di idrati di silicato di calcio autoclavato, incombustibile e con elevata diffusività al vapore. Dotato di omologazione ETA 05/0093 secondo EAD 040012-00-1201.</p> | <p>Mineral insulation panel suitable for ETICS external thermal insulation systems. Contains autoclaved calcium silicate hydrates, is non-combustible and provides high vapour diffusivity. ETA 05/0093-certified according to EAD 040012-00-1201.</p> | <p>Panel aislante mineral idóneo para la aplicación por capas SATE, a base de hidratos de silicato de calcio autoclavado, incombustible y con gran capacidad de difusión del vapor. Homologado ETA 05/0093 según EAD 040012-00-1201.</p> |
| <p>Per sistema: TermoK8 Minerale Eco Formato: 60 x 39 cm Spessore: da 6 a 14 cm Resistenza a trazione TR ≥ 80 kPa Resistenza a compressione CS(10) ≥ 300 kPa Classe reazione fuoco del pannello: A1</p> | <p>For the system: TermoK8 Minerale Eco Size: 60 x 39 cm Thickness: from 6 to 14 cm Tensile strength: TR ≥ 80 kPa Compressive strength: CS(10) ≥ 300 kPa Panel fire reaction class: A1</p> | <p>Para sistema: TermoK8 Minerale Eco Medidas: 60 x 39 cm Espesor: de 6 a 14 cm Resistencia a la tracción: TR ≥ 80 kPa Resistencia a la compresión CS(10) ≥ 300 kPa Clase de reacción al fuego del panel: A1</p> |

tecniche



certificazioni



stiferite class SK

scheda
tecnicadata
sheetficha
técnicapannello in poliuretano espanso
rigido

Pannello isolante in schiuma polyiso espansa (PIR), idoneo per l'applicazione a cappotto ETICS, con elevate prestazioni di isolamento termico, rivestito su entrambe le facce con velo vetro saturato. Omologato secondo EAD 040083-00-0404 già ETAG 004.

Per sistema: Termok8 Slim
Formato: 120 x 60 cm
Spessore: da 2 a 20 cm
Resistenza a trazione TR ≥ 80 kPa
Classe reazione fuoco del sistema
Termok8: B-s1,d0

rigid polyurethane foam panel

Polyiso foam insulation panel (PIR), suitable for ETICS external thermal insulation systems, with high thermal insulation performance, coated on both sides with a thin film of saturated glass. Approved according to EAD 040083-00-0404 (formerly ETAG 004).

For the system: Termok8 Slim
Size: 120 x 60 cm
Thickness: from 2 to 20 cm
Tensile strength: TR ≥ 80 kPa
Termok8 system fire reaction class:
B-s1,d0

panel en poliuretano expandido
rígido

Panel aislante en espuma polyiso (PIR), idóneo para la aplicación por capas SATE, con altas prestaciones de aislamiento térmico, revestido por las dos caras con velo de vidrio saturado. Homologado según EAD 040083-00-0404, antes ETAG 004.

Para sistema: Termok8 Slim
Medidas: 120 x 60 cm
Espesor: de 2 a 20 cm
Resistencia a la tracción: TR ≥ 80 kPa
Clase de reacción al fuego del sistema
Termok8: B-s1,d0

tecniche



certificazioni



sughero ambrato

scheda
tecnicadata
sheetficha
técnica

pannello in sughero ambrato

Pannello per isolamento termo-acustico realizzato in sughero espanso, autocollato, idoneo per l'applicazione a cappotto ETICS, totalmente naturale poiché ottenuto tramite processo termico di tostatura, quindi senza aggiunta di colle o di sostanze chimiche, certificato secondo UNI EN 13170. Certificato per la bioedilizia da Natureplus, ANAB ed ICEA.

Per sistema: Termok8 Sughero
Formato: 100 x 50 cm
Spessore: da 3 a 18 cm
Densità: 110 kg/m³
Resistenza a compressione CS(10) ≥ 100 kPa

amber cork panel

Thermal and acoustic insulation panel made of self-adhesive expanded cork, suitable for ETICS external thermal insulation systems. It is totally natural since it is obtained through a thermal toasting process which does not use glues or chemical substances. UNI EN 13170 certified. Certified for green housing by Natureplus, ANAB and ICEA.

For the system: Termok8 Sughero
Size: 100 x 50 cm
Thickness: from 3 to 18 cm
Density: 110 kg/m³
Compressive strength: CS(10) ≥ 100 kPa

panel en corcho ámbar

Panel para aislamiento termo-acústico realizado en corcho expandido, autoencolado, idóneo para la aplicación por capas SATE, totalmente natural porque se obtiene mediante proceso térmico de tostado, es decir, sin añadido de colas o de sustancias químicas, certificado según UNI EN 13170. Certificado para eco-arquitectura por Natureplus, ANAB y ICEA.

Para sistema: Termok8 Sughero (corcho)
Medidas: 100 x 50 cm
Espesor: de 3 a 18 cm
Densidad: 110 kg/m³
Resistencia a la compresión CS(10) ≥ 100 kPa

tecniche



certificazioni



PH 20

scheda
tecnicadata
sheetficha
técnicapannello in resina fenolica espansa
rigida

Pannello isolante in schiuma di resina fenolica espansa (PF), idoneo per l'applicazione a cappotto ETICS, con elevate prestazioni di isolamento termico, rivestito su entrambi i lati con velo vetro saturato. Omologato secondo UNI EN 13166.

Per sistema: Termok8 Fenolico
Formato: 120 x 60 cm (per lastre da 2 e 3 cm dimensione lastra 120x120 cm)
Spessore: da 2 a 16 cm
Resistenza a trazione TR ≥ 80 kPa
Classe reazione fuoco del sistema
Termok8: B-s1,d0

rigid phenolic resin foam panel

Phenolic resin foam (PF) insulation panel, suitable for ETICS external thermal insulation systems, with high thermal insulation performance, coated on both sides with a thin film of saturated glass. Approved according to UNI EN 13166.

For the system: Termok8 Fenolico
Size: 120 x 60 cm (for 2 and 3 cm slabs measuring 120x120 cm)
Thickness: from 2 to 16 cm
Tensile strength: TR ≥ 80 kPa
Termok8 system fire reaction class:
B-s1,d0

panel en resina fenólica expandida
rígida

Panel aislante en espuma de resina fenólica expandida (PF), idóneo para la aplicación por capas SATE, con altas prestaciones de aislamiento térmico, revestido por las dos caras con velo de vidrio saturado. Homologado según UNI EN 13166.

Para sistema: Termok8 Fenólico
Medidas: 120 x 60 cm (para placas de 2 y 3 cm medidas de la placa 120x120 cm)
Espesor: de 2 a 16 cm
Resistencia a la tracción: TR ≥ 80 kPa
Clase de reacción al fuego del sistema
Termok8: B-s1,d0

tecniche



certificazioni



PH 20 king



scheda
tecnica



data
sheet



ficha
técnica



pannello in resina fenolica espansa rigida

Pannello per isolamento termico realizzato in schiuma di resina fenolica espansa (PF), espansa senza l'impiego di CFC o HCFC e HFC, certificato ETICS secondo le linee guida ETAG 004:2013. Certificato in sistema 3 di Valutazione e Verifica della Costanza della Prestazione (VVCP) secondo UNI EN 13166:2016. Rivestito su entrambe le facce con velo vetro saturato.

Per sistema: Termok8 Fenolico
Formato: 120 x 40 cm
Spessore: da 2 a 16 cm
Resistenza a trazione TR ≥ 80 kPa
Classe reazione fuoco del sistema Termok8: C-s2,d0

rigid phenolic resin foam panel

Expanded Phenolic resin foam (PF) insulation panel, expanded without the use of CFCs or HCFCs and HFCs, ETICS certified according to the ETAG 004: 2013 guidelines. Certified in system 3 of Evaluation and Verification of Constancy of Performance according to UNI EN 13166: 2016. Covered on both sides with saturated glass veil.

For the system: Termok8 Fenolico
Size: 120 x 40 cm
Thickness: from 2 to 16 cm
Tensile strength: TR ≥ 80 kPa
Termok8 system fire reaction class: C-s2,d0

panel en resina fenólica expandida rígida

Panel aislante en espuma de resina fenólica expandida (PF) expandida sin el uso de CFC o HCFC y HFC, certificado SATE según la normativa ETAG 004: 2013. Certificado en el sistema 3 de Evaluación y Verificación de Constancia de Desempeño (VVCP) según UNI EN 13166: 2016. Revestido por ambos lados con velo de vidrio saturado.

Para sistema: Termok8 Fenolico
Medidas: 120 x 40 cm
Espesor: da 2 a 16 cm
Resistencia a la tracción: TR ≥ 80 kPa
Clase reacción fuoco del sistema Termok8: C-s2,d0

tecniche



certificazioni



fibra di legno



scheda
tecnica



data
sheet



ficha
técnica



pannello in EPS fibra di legno

Pannello isolante in fibre legno monostrato pressate (WF) idoneo per l'applicazione a cappotto ETICS, intonacabile, rigido, idro-fugo, con prestazioni di isolamento termico, acustico e con elevata diffusività al vapore. Omologato secondo UNI EN 13171. Certificato per la bioedilizia da Natureplus.

Per sistema: Termok8 Wood
Formato: 125 x 60 cm
Spessore: da 6 a 20 cm
Densità: 140 kg/m³
Resistenza a compressione CS(10) ≥ 100 kPa
Resistenza a trazione TR ≥ 20 kPa

Wood EPS fibreboard panel

Single layer pressed wood fibreboard (WF) insulation panel suitable for ETICS external thermal insulation systems. Can be plastered over. It is stiff, waterproof and provides thermal and acoustic insulation and high vapour diffusivity. Approved according to UNI EN 13171. Certified for green housing by Natureplus.

For the system: Termok8 Wood
Size: 125 x 60 cm
Thickness: from 6 to 20 cm
Density: 140 kg/m³
Compressive strength: CS(10) ≥ 100 kPa
Tensile strength: TR ≥ 20 kPa

panel en EPS fibra de madera

Panel aislante en fibras de madera en una sola capa prensadas (WF) idóneo para la aplicación por capas SATE, admite enlucado, rígido, hidrófugo, con prestaciones de aislamiento térmico, acústico y con gran capacidad de difusión del vapor. Homologado según UNI EN 13171. Certificado para eco-arquitectura por Natureplus.

Para sistema: Termok8 Wood
Medidas: 125 x 60 cm
Espesor: de 6 a 20 cm
Densidad: 140 kg/m³
Resistencia a la compresión CS(10) ≥ 100 kPa
Resistencia a la tracción: TR ≥ 20 kPa

tecniche



certificazioni



aeropan



scheda
tecnica



data
sheet



ficha
técnica



pannello in EPS aerogel per l'isolamento dei ponti termici

Pannello isolante in aerogel, idoneo per l'isolamento di dettagli costruttivi di facciata quali imbotti, loggiati ed intradossi, con sorprendenti prestazioni di isolamento termico. Rivestito, sul lato esterno, con una membrana traspirante in polipropilene armato con fibra di vetro specifico per l'applicazione a cappotto ETICS. Dotato di omologazione ETA 20/0562 secondo EAD 040037-00-1201.

Per isolamento di ponti termici
Formato: 140 x 72 cm
Spessore: da 1 a 6 cm

EPS aerogel panel for insulation of thermal bridges

Aerogel insulation panel, suitable for insulating façade construction details such as soffits, porticos and intrados, providing outstanding thermal insulation. Coated on the outside with a breathable, fibreglass-reinforced polypropylene membrane specifically designed for ETICS external thermal insulation systems. ETA 20/0562-certified according to EAD 040037-00-1201.

For the insulation of thermal bridges
Size: 140 x 72 cm
Thickness: from 1 to 6 cm

panel en EPS aerogel para aislamiento de puentes térmicos

Panel aislante en aerogel, idóneo para el aislamiento de detalles de construcción de fachada, como galerías porticadas y intrados con sorprendentes prestaciones de aislamiento térmico. Revestido, por su lado exterior, con una membrana transpirante en polipropileno armado con fibra de vidrio, específico para la aplicación por capas ETICS. Homologado ETA 20/0562 según EAD 040037-00-1201.

Para aislamiento de puentes térmicos
Medidas: 140 x 72 cm
Espesor: de 1 a 6 cm

tecniche



certificazioni



tassello H2

 scheda
tecnica

 data
sheet

 ficha
técnica

| | | |
|---|---|--|
| tassello a percussione in HDPE e perno in acciaio zincato galvanizzato | HDPE percussion anchors and galvanised steel pin | taco de percusión en HDPE y perno de acero zincado galvanizado |
| Tassello universale a percussione con doppia zona di espansione (25/45mm) per calcestruzzo, laterizi pieni e forati, calcestruzzo alleggerito e calcestruzzo cellulare. Piattello telescopico, basculante, sottile e ad alta rigidità. Dotato di omologazione secondo EAD 330196-01-0604. | Universal percussion anchor with double expansion sleeve (25/45 mm) for concrete, solid and hollow brick, lightweight concrete and porous concrete. Telescoping, tilting, thin and highly stiff plate. Certified according to EAD 330196-01-0604. | Taco universal de percusión con doble zona de expansión (25/45 mm) para hormigón, ladrillos macizos y huecos, hormigón aligerado y hormigón celular. Plato telescópico, basculante, fino y de alta rigidez. Homologado según EAD 330196-01-0604. |
| Diametro stelo/foro: 8 mm Diametro piattello: 60 mm Profondità di foratura: 35 mm (55 mm cat. D, E) Profondità di ancoraggio: 25 mm (45 mm cat. D, E) Categorie d'utilizzo ETA: A, B, C, D, E | Shank/Bore Diameter: 8 mm Plate Diameter: 60 mm Drilling Depth: 35 mm (55 mm cat. D, E) Anchoring Depth: 25 mm (45 mm cat. D, E) ETA usage categories: A, B, C, D, E | Diámetro del vástago/agujero: 8 mm Diámetro del plato: 60 mm Profundidad de perforación: 35 mm (55 mm cat. D, E) Profundidad de anclaje: 25 mm (45 mm cat. D, E) Categorías de uso ETA: A, B, C, D, E |

| tecniche | certificazioni | proprietà | tecnologie |
|----------|----------------|-----------|------------|
| | | | |

tassello CT 2G

 scheda
tecnica

 data
sheet

 ficha
técnica

| | | |
|---|---|--|
| tassello ad avvitamento in HDPE vite in acciaio zincato e galvanizzato | HDPE screw anchor with galvanised steel screw | taco de rosca en HDPE con tornillo de acero zincado y galvanizado |
| Tassello universale ad avvitamento con zona di espansione in HDPE e vite in acciaio zincato galvanizzato per calcestruzzo, laterizi pieni e forati, calcestruzzo alleggerito e calcestruzzo cellulare per applicazioni a filo e ad incasso. Dotato di omologazione secondo EAD 330196-01-0604. | Universal screw anchor with HDPE expansion sleeve and galvanised steel screw designed for flush and recessed application in concrete, solid and hollow brick, lightweight concrete and porous concrete. Certified according to EAD 330196-01-0604. | Taco universal de rosca con zona de expansión en HDPE y tornillo de acero zincado y galvanizado para hormigón, ladrillos macizos y huecos, hormigón aligerado y hormigón celular para aplicaciones al ras y empotradas. Homologado según EAD 330196-01-0604. |
| Necessario per Termok8 Modulare e idonei per tutti gli altri Diametro stelo/foro: 8 mm Diametro piattello: 60 mm Profondità di ancoraggio: ≥ 25 mm Categorie d'utilizzo ETA: A, B, C, D, E Per montaggio a filo esterno utilizzare "tamponcino in EPS", per montaggio ad incasso utilizzare Copritassello in EPS/Lana di roccia. | For the Termok8 modular system and suitable for all other systems Shank/Bore Diameter: 8 mm Plate Diameter: 60 mm Anchoring depth: ≥ 25 mm ETA usage categories: A, B, C, D, E For flush surface mounting, use "tamponcino in EPS" plug, for recessed use "copritassello in EPS/LANA DI ROCCIA" cap, | Necesario para Termok8 Modular e idoneo para todos los demás sistemas Diámetro del vástago/agujero: 8 mm Diámetro del plato: 60 mm Profundidad de anclaje: ≥ 25 mm Categorías de uso ETA: A, B, C, D, E Para el montaje al ras exterior utilizar el tapón "tamponcino in EPS", para montaje empotrado utilizar el cubretaco "copritassello in EPS/Lana di Roccia" |

| tecniche | certificazioni | proprietà | tecnologie |
|----------|----------------|-----------|------------|
| | | | |

tassello CT L



scheda
tecnica



data
sheet



ficha
técnica



| | | |
|---|---|--|
| <p>tassello ad avvitamento con vite autofilettante in acciaio zincato galvanizzato</p> | <p>HDPE screw anchor with self-tapping galvanised steel screw</p> | <p>taco de rosca con tornillo autorroscante de acero zincado galvanizado</p> |
| <p>Tassello universale ad avvitamento con vite autofilettante premontata in acciaio zincato galvanizzato per supporti in legno massiccio, OSB, truciolato e su sottostrutture in acciaio o alluminio fino a 0,75mm per applicazioni a filo e ad incasso. Per montaggio a filo esterno utilizzare "tamponcino in EPS" già compreso nella confezione, o per montaggio ad incasso "copritassello in EPS/Lana di Roccia" acquistabili separatamente. A richiesta "talpa" per pannello isolante.</p> | <p>Universal screw anchor with pre-mounted, self-tapping galvanised steel screw for solid wood, OSB, chipboard and for flush and recessed application in steel or aluminium support structures of up to 0.75 mm thick. For flush surface mounting, use "tamponcino in EPS" plug included in the package or, for recessed mounting, use "copritassello in EPS/Lana di Roccia" cap, available separately. A circular drill bit for insulating panels is available upon request.</p> | <p>Taco universal de rosca con tornillo autorroscante premontado de acero zincado galvanizado para soportes de madera maciza, OSB, aglomerado y sobre subestructuras de acero o aluminio hasta 0,75mm para aplicaciones al ras y empotradas. Para el montaje al ras exterior utilizar el tapón "tamponcino in EPS" ya incluido en el envase; para montaje empotrado utilizar cubretaco "copritassello in EPS/Lana di Roccia", que puede comprarse por separado. Bajo pedido, roseta de fijación para panel aislante.</p> |
| <p>Diametro stelo/foro: 6 mm Diametro piattello: 60 mm Profondità di ancoraggio: 30-40 mm</p> | <p>Shank/Bore Diameter: 6 mm Plate Diameter: 60 mm Anchoring Depth: 30-40 mm</p> | <p>Diámetro del vástago/agujero: 6 mm Diámetro del plato: 60 mm Profundidad de anclaje: 30-40 mm</p> |

| tecniche | certificazioni | proprietà | tecnologie |
|----------|----------------|-----------|------------|
| | | | |

tassello CT L A2



scheda
tecnica



data
sheet



ficha
técnica



| | | |
|--|--|---|
| <p>tassello ad avvitamento con vite autofilettante anticorrosione</p> | <p>screw anchor for reduced thickness insulation</p> | <p>taco de rosca para bajos espesores de aislante</p> |
| <p>Tassello universale ad avvitamento con vite autoforante premontata in acciaio inox anticorrosione per supporti in legno massiccio, OSB, truciolato e su sottostrutture in acciaio o alluminio per applicazioni a filo e ad incasso.</p> | <p>Universal screw-on anchor with pre-assembled self-drilling screw in corrosion-resistant stainless steel for supports in solid wood, OSB, chipboard and on steel or aluminium substructures for flush and recessed applications.</p> | <p>Anclaje atornillable universal con tornillo autotaladrante premontado de acero inoxidable resistente a la corrosión para soportes de madera maciza, OSB, aglomerado y sobre subestructuras de acero o aluminio para aplicaciones enrasadas y empotradas.</p> |
| <p>Diametro stelo/foro: 6 mm Diametro piattello: 60 mm Profondità di ancoraggio: 30-40 mm</p> | <p>Rod / hole diameter: 6 mm Plate diameter: 60 mm Anchoring depth: 30-40 mm</p> | <p>Diámetro de varilla/agujero: 6 mm Diámetro de la placa: 60 mm Profundidad de anclaje: 30-40 mm</p> |

| tecniche | certificazioni | proprietà | tecnologie |
|----------|----------------|-----------|------------|
| | | | |

tassello CT S1



scheda
tecnica



data
sheet



ficha
técnica



| | | |
|---|--|---|
| <p>tassello ad avvitamento per spessori di isolante ridotti</p> | <p>screw anchor with corrosion-resistant, self-tapping screw</p> | <p>taco de rosca con tornillo autorroscante anticorrosión</p> |
| <p>Tassello ad avvitamento con vite in materiale sintetico, specifico per spessori di isolante ridotti tipo AEROGEL o similari, idoneo per calcestruzzo, laterizi pieni e forati, calcestruzzo alleggerito e calcestruzzo cellulare per applicazioni a filo. Montaggio consentito per spessori di isolamento ≥ 20mm. Dotato di omologazione secondo EAD 330196-01-0604.</p> | <p>Screwed anchor with screw in synthetic material, specific for reduced thicknesses of insulation such as AIRGEL or similar, suitable for concrete, solid and perforated bricks, lightened concrete and cellular concrete for flush applications. Assembly permitted for insulation thicknesses ≥ 20mm. Equipped with approval according to EAD 330196-01-0604.</p> | <p>Anclaje atornillado con tornillo en material sintético, específico para espesores reducidos de aislamiento tipo AIRGEL o similar, apto para hormigón, ladrillo macizo y perforado, hormigón aligerado y hormigón celular para aplicaciones enrasadas. Montaje permitido para espesores de aislamiento ≥ 20 mm. Equipado con homologación según EAD 330196-01-0604.</p> |
| <p>Diametro stelo/foro: 8 mm Diametro piattello: 60 mm Profondità di ancoraggio: ≥ 30 mm. categorie d'applicazione A B C D Profondità di ancoraggio: ≥ 50 mm. categorie d'applicazione E Categorie d'utilizzo ETA: A, B, C,D,E</p> | <p>Rod / hole diameter: 8 mm Plate diameter: 60 mm Anchoring depth: ≥ 30 mm. application categories A B C D Anchoring depth: ≥ 50 mm. application categories E ETA use categories: A, B, C,D,E</p> | <p>Diámetro de varilla/agujero: 8 mm Diámetro de la placa: 60 mm Profundidad de anclaje: ≥ 30 mm. categorías de aplicación A B C D Profundidad de anclaje: ≥ 50 mm. categorías de aplicación E Categorías de uso ETA: A, B, C,D, E</p> |

| tecniche | certificazioni | proprietà | tecnologie |
|----------|----------------|-----------|------------|
| | | | |

tassello H3

 scheda
tecnica

 data
sheet

 ficha
técnica

| tassello a percussione in hdpe | hdpe percussion anchor | taco de percusión en hdpe |
|---|---|--|
| Tassello universale a percussione con zona di espansione in HDPE per cls, laterizio pieno e forato con perno di espansione in PAGF 50 premontato. Piattello telescopico, basculante, sottile e ad alta rigidità. Dotato di omologazione secondo EAD 330196-01-0604. | Universal percussion anchor with HDPE expansion sleeve for concrete, solid brick and hollow brick with pre-installed PAGF 50 expansion pin. Telescoping, tilting, thin and highly stiff plate. Certified according to EAD 330196-01-0604. | Taco universal de percusión con zona de expansión en HDPE para hormigón, ladrillos macizos y ladrillos huecos con perno de expansión en PAGF 50 premontado. lato telescópico, basculante, fino y de alta rigidez. Homologado según EAD 330196-01-0604. |
| Diametro stelo: 8 mm Diametro piattello: 60 mm Profondità di ancoraggio: ≥ 25 mm Categorie d'utilizzo ETA: A, B, C | Shank Diameter: 8 mm Plate Diameter: 60 mm Anchoring depth ≥ 25 mm ETA usage categories: A, B, C | Diámetro del vástago: 8 mm Diámetro del plato: 60 mm Profundidad de anclaje: ≥ 25 mm Categorías de uso ETA: A, B, C |

| tecniche | certificazioni | proprietà | tecnologie |
|----------|----------------|-----------|------------|
| | | | |

tassello SDK U

 scheda
tecnica

 data
sheet

 ficha
técnica

| tassello ad avvitamento per guide Termok8 meccanico o profili di partenza | screw anchor For the Termok8: mechanical system guides or base profiles | taco de rosca para guías Termok8 mecánico o perfiles iniciales |
|--|---|--|
| Tassello ad avvitamento (senza piattello) con vite autofilettante premontata in acciaio zincato galvanizzato per il fissaggio di guide orizzontali di sistemi a cappotto ad ancoraggio di tipo meccanico e di profili di partenza su calcestruzzo, laterizi pieni e forati, calcestruzzo alleggerito e calcestruzzo cellulare. Dotato di Certificazione EAD 330196-01-0604 | Screw anchor (without plate) with pre-mounted self-tapping screw of galvanised steel for fastening horizontal system guides for mechanically anchored external thermal insulation systems and base profiles on concrete, solid and hollow brick, lightweight concrete and porous concrete. EAD 330196-01-0604 certified | Taco de rosca (sin plato) con tornillo autorroscante premontado de acero zincado galvanizado para la fijación de guías horizontales de sistemas por capas con anclaje de tipo mecánico, así como para perfiles iniciales sobre hormigón, ladrillos macizos y huecos, hormigón aligerado y hormigón celular. Dotado de Certificación EAD 330196-01-0604 |
| Diametro stelo/foro: 8 mm Profondità di ancoraggio: ≥ 25 mm. categorie d'applicazione A B C D Profondità di ancoraggio: ≥ 65 mm. categorie d'applicazione E Categorie d'utilizzo ETA: A, B, C, D, E | Shank/Bore Diameter: 8 mm Anchoring depth ≥ 25 mm. Application categories: A B C D Anchoring depth ≥ 65 mm. Application categories: E ETA usage categories: A, B, C, D, E | Diámetro del vástago/agujero: 8 mm Profundidad de anclaje: ≥ 25 mm, categorías de aplicación: A B C D Profundidad de anclaje: ≥ 65 mm, categoría de aplicación: E Categorías de uso ETA: A, B, C, D, E |

| tecniche | certificazioni | proprietà | tecnologie |
|----------|----------------|-----------|------------|
| | | | |

tassello ND K

 scheda
tecnica

 data
sheet

 ficha
técnica

| tassello a percussione per profili di partenza | percussion anchor for base profiles | taco de percusión para perfiles iniciales |
|---|--|---|
| Tassello a percussione e ad avvitamento senza piattello per il fissaggio di profili di partenza di sistemi a cappotto ETICS, con vite in acciaio zincato. | Percussion and screw anchor without plate for fastening base profiles of ETICS external thermal insulation systems, with galvanised steel screw. | Taco de percusión y de rosca sin plato para la fijación de perfiles iniciales de sistemas por capas ETICS, con tornillo de acero zincado. |
| Dimensioni: 6 mm, L=60 mm - 8 mm, L=80 mm Profondità di ancoraggio: ≤30 mm | Size: 6 mm, L = 60 mm - 8 mm, L=80 mm Anchoring depth ≤30 mm | Medidas: 6 mm, L=60 mm - 8 mm, L=80 mm Profundidad de anclaje: ≤30 mm |

rondella per lana di roccia VT 2G



| rondella aggiuntiva in caso di montaggio ad incasso su lana minerale | additional washer for recessed mounting on mineral wool | arandela adicional en caso de montaje empotrado sobre lana mineral |
|--|---|---|
| Rondella utile per ampliare la dimensione del piattello dei tasselli CT 2G, CT L e CT L A2 in caso di applicazione ad incasso su lana minerale a bassa densità o a doppia densità. | Washer used to extend dimensions of CT 2G, CT L and CT L A2 anchor plates for recessed application on low-density or double density mineral wool. | Arandela útil para ampliar el tamaño del plato de los tacos CT 2G, CT L y CT L A2 en caso de aplicación empotrada sobre lana mineral de baja densidad o doble densidad. |

| tecniche | certificazioni | proprietà | tecnologie |
|----------|----------------|-----------|------------|
| | | | |

rondella per lana di roccia 90 mm



| | | |
|---|--|---|
| rondella aggiuntiva in caso di montaggio a filo su lana minerale | additional washer for flush mounting on mineral wool | arandela adicional en caso de montaje al ras sobre lana mineral |
| Rondella utile per ampliare la dimensione del piattello dei tasselli CT 2G, CT L e CT L A2 ad un'ampiezza di mm 90 in caso di applicazione a filo su lana minerale a bassa densità. | Washer used to extend dimensions of CT 2G, CT L and CT L A2 anchor plates to a width of 90 mm for application on low-density mineral wool. | Arandela útil para ampliar el tamaño del plato de los tacos CT 2G, CT L y CT L A2 hasta un ancho de 90 mm en caso de aplicación al ras sobre lana mineral de baja densidad. |
| Dimensioni Ø 90 mm | Size: Ø 90 mm | Medidas Ø 90 mm |

| tecniche | certificazioni | proprietà | tecnologie |
|----------|----------------|-----------|------------|
| | | | |

rondella per lana di roccia 140 mm



| | | |
|---|--|--|
| rondella aggiuntiva in caso di montaggio a filo su lana minerale | additional washer for flush mounting on mineral wool | arandela adicional en caso de montaje al ras sobre lana mineral |
| Rondella utile per ampliare la dimensione del piattello dei tasselli CT 2G, CT L e CT L A2 ad un'ampiezza di mm 140 in caso di applicazione a filo su lana di roccia lamellare. | Washer used to extend dimensions of CT 2G, CT L and CT L A2 anchor plates to a width of 140 mm for flush application on laminated rock wool. | Arandela útil para ampliar el tamaño del plato de los tacos CT 2G, CT L y CT L A2 hasta un ancho de 90 mm en caso de aplicación al ras sobre lana de roca laminar. |
| Dimensioni Ø 140 mm | Size: Ø 140 mm | Medidas Ø 140 mm |

| tecniche | certificazioni | proprietà | tecnologie |
|----------|----------------|-----------|------------|
| | | | |

tappo in EPS per tassello CT 2G - CT L



| | | |
|--|--|--|
| cilindretti per tasselli CT 2G per montaggio a filo | cylinders for CT 2G anchors -flush mounting | cilindros para montaje de tacos CT 2G |
| tamponcino di chiusura in polistirolo (EPS) da abbinare ai tasselli CT 2G in caso di montaggio a filo del tassello sul pannello. | polystyrene (EPS) closure pad for use with CT 2G, CT L anchors for flush mounting the anchor on the panel. | tapón de cierre en poliestireno (EPS) para tacos CT 2G, CT L en caso de montaje al ras del taco en el panel. |
| Dimensioni: L= 14,9 mm | Size L= 14.9 mm | Medidas: L= 14,9 mm |

copritassello



| | | |
|--|---|--|
| tappo in eps per applicazioni a incasso | eps plug for recessed applications | tapón en eps para aplicaciones empotradas |
| Tappi di chiusura utilizzati in abbinamento ai tasselli CT 2G, CT L e CT L A2 in caso di montaggio ad incasso. | Plugs for use with CT 2G, CT L and CT L A2 anchors for recessed mounting. | Tapones de cierre utilizados con los tacos CT 2G, CT L y CT L A2 en caso de montaje empotrado. |
| Diametro: mm 60. | Diameter: 60 mm. | Diámetro: 60 mm. |

spalletta isolante per imbotte lai-sys eps

 scheda
 tecnica

| spalletta isolante prerasata in eps | preskimmed eps insulation reveal | jamba aislante pre-enrasada en eps |
|---|--|---|
| <p>Spalletta prefinita LAI-SYS per l'isolamento della spalletta nell'imbotte della finestra. Trattasi di un EPS bianco già rasato con finitura cementizia e paraspigolo già integrato.</p> | <p>Prefinished LAI-SYS reveal for insulation of window intrados reveals. White, preskimmed EPS with cement-based finish and built-in corner bead.</p> | <p>Jamba con acabado previo LAI-SYS para el aislamiento de la jamba en el intradós de la ventana. Se trata de un material EPS blanco ya enrasado con acabado de cemento y protector de aristas ya integrado.</p> |
| <p>Conducibilità termica: $\lambda = 0,035$ W/mK Spessore: 14 mm Profondità: 400 mm Lunghezze disponibili: 1350 - 1600 - 2000 - 2500 mm N.B. su richiesta anche larghezza 155/195/235/300</p> | <p>Thermal conductivity: $\lambda = 0.035$ W/mK Thickness: 14 mm Depth: 400 mm Available lengths: 1350 - 1600 - 2000 - 2500 mm Note: upon request, widths of 155/195/235/300</p> | <p>Conductividad térmica: $\lambda = 0,035$ W/mK Espesor: 14 mm Profundidad: 400 mm Largoes disponibles: 1350 - 1600 - 2000 - 2500 mm Nota: bajo pedido, también anchos 155/195/235/300</p> |

spalletta isolante per imbotte lai-sys pu

 scheda
 tecnica

| spalletta isolante prerasata in poliuretano | preskimmed polyurethane insulation reveal | jamba aislante pre-enrasada en poliuretano |
|---|--|---|
| <p>Spalletta prefinita LAI-SYS per l'isolamento della spalletta nell'imbotte della finestra. Trattasi di un poliuretano già rasato con finitura cementizia e paraspigolo già integrato.</p> | <p>Prefinished LAI-SYS reveal for insulation of window intrados reveals. Preskimmed polyurethane reveal with cement-based finish and built-in corner bead.</p> | <p>Jamba con acabado previo LAI-SYS para el aislamiento de la jamba en el intradós de la ventana. Se trata de un poliuretano ya enrasado con acabado de cemento y protector de aristas ya integrado.</p> |
| <p>Conducibilità termica: $\lambda = 0,029$ W/mK Spessore: 24 mm Profondità: 400 mm Lunghezze disponibili: 1350 - 1600 - 2000 - 2500 mm N.B. su richiesta anche larghezza 155/195/235/300</p> | <p>Thermal conductivity: $\lambda = 0.029$ W/mK Thickness: 24 mm Depth: 400 mm Available lengths: 1350 - 1600 - 2000 - 2500 mm Note: upon request, widths of 155/195/235/300</p> | <p>Conductividad térmica: $\lambda = 0,029$ W/mK Espesor: 24 mm Profundidad: 400 mm Largoes disponibles: 1350 - 1600 - 2000 - 2500 mm Nota: bajo pedido, también anchos 155/195/235/300</p> |

spalletta isolante per imbotte lai-sys mw

 scheda
 tecnica

| spalletta isolante prerasata in lana di roccia | preskimmed rock wool insulation reveal | jamba aislante pre-enrasada en lana de roca |
|---|--|---|
| <p>Spalletta prefinita LAI-SYS per l'isolamento della spalletta nell'imbotte della finestra. Trattasi di lana di roccia già rasata con finitura cementizia e paraspigolo già integrato.</p> | <p>Prefinished LAI-SYS reveal for insulation of window intrados reveals. Preskimmed rock wool reveal with cement-based finish and built-in corner bead.</p> | <p>Jamba con acabado previo LAI-SYS para el aislamiento de la jamba en el intradós de la ventana. Se trata de lana de roca ya enrasada con acabado de cemento y protector de aristas ya integrado.</p> |
| <p>Conducibilità termica: $\lambda = 0,037$ W/mK Spessore: 24 mm Profondità: 400 mm Lunghezze disponibili: 1350 - 1600 - 2000 - 2500 mm N.B. su richiesta anche larghezza 155/195/235/300</p> | <p>Thermal conductivity: $\lambda = 0.037$ W/mK Thickness: 24 mm Depth: 400 mm Available lengths: 1350 - 1600 - 2000 - 2500 mm Note: upon request, widths of 155/195/235/300</p> | <p>Conductividad térmica: $\lambda = 0,037$ W/mK Espesor: 24 mm Profundidad: 400 mm Largoes disponibles: 1350 - 1600 - 2000 - 2500 mm Nota: bajo pedido, también anchos 155/195/235/300</p> |

profilo di connessione TYP U



scheda
tecnica



| profilo di raccordo spalletta-tapparella | reveal-roller shutter connection profile | perfil de conexión jamba-persiana |
|--|--|---|
| <p>Profilo di connessione in alluminio per la protezione della spalletta LAI-SYS in presenza di tapparelle scorrevoli. Da fissare meccanicamente nell'imbotte finestra. Consente di creare una zona portante dove far arrivare in battuta la spalletta Lai-Sys e, al contempo, proteggerla dagli urti meccanici dovuti alla movimentazione della tapparella.</p> | <p>Aluminium connection profile to protect the LAI-SYS reveal when roller shutters are used. To be mechanically fastened to the window intrados. Makes it possible to create a load-bearing area used for flush contact with the Lai-Sys reveal and, at the same time, serves to protect it from the mechanical impacts of shutter movement.</p> | <p>Perfil de conexión en aluminio para la protección de la jamba LAI-SYS en presencia de persianas deslizantes. Para fijar mecánicamente en el intradós de la ventana. Permite crear una zona portante en la que puede hacer tope la jamba Lai-Sys para, además, protegerla de los golpes mecánicos debidos al movimiento de la persiana.</p> |
| <p>Dimensione: sp.14 x 2500 mm sp.24 x 2500 mm</p> | <p>Size: th. 14 x 2500 mm th. 24 x 2500 mm</p> | <p>Medidas: esp.14 x 2500 mm esp. 24 x 2500 mm</p> |

profilo di connessione PVC U-AL



scheda
tecnica



| profilo di raccordo spalletta-tapparella | reveal-roller shutter connection profile | perfil de conexión jamba-persiana |
|---|---|--|
| <p>Profilo di connessione in PVC per la protezione della spalletta LAI-SYS contro serramento o contro il binario a vista della tapparella. Munito di aletta removibile, autoadesivo e verniciabile. Certificato per la tenuta all'aria e all'acqua.</p> | <p>PVC connection profile to protect the LAI-SYS reveal from the roller shutter frame or its visible track. Equipped with removable, self-adhesive and paintable flap. Certified for air and water tightness.</p> | <p>Perfil de conexión en PVC para la protección de la jamba LAI-SYS contra el cierre o contra el riel a la vista de la persiana. Dotado de aleta extraíble, autoadhesivo, admite recubrimiento de pintura. Certificado para el sellado de protección frente al aire y el agua.</p> |
| <p>Spessori disponibili: 14 - 24 mm Lunghezze disponibili: 1350 - 1600 - 2000 mm</p> | <p>Available thicknesses: 14 - 24 mm Available lengths: 1350 - 1600 - 2000 mm</p> | <p>Espesores disponibles: 14 - 24 mm Largoes disponibles: 1350 - 1600 - 2000 mm</p> |

profilo orizzontale OR/LT

 scheda
 tecnica

| profili di ancoraggio orizzontali per cappotto meccanico | horizontal anchor profiles for mechanical external thermal insulation system | perfiles de anclaje horizontales para sistema por capas mecánico |
|---|---|---|
| <p>Profilo estruso in lega d'alluminio per il fissaggio orizzontale del sistema TermoK8 Meccanico atto a sostenere i pannelli EPS Meccanico R ed EPS G Meccanico R appositamente realizzati con scanalature ad incastro. Da fissare meccanicamente mediante tasselli SDK U.</p> | <p>Extruded aluminium alloy profile for horizontal fastening the TermoK8 mechanical system to support the specially designed EPS Meccanico R and EPS G Meccanico R panels with interlocking grooves. To be mechanically fastened using SDK U anchors.</p> | <p>Perfil extruido en aleación de aluminio para la fijación horizontal del sistema TermoK8 Mecánico, que permite sostener los paneles EPS Meccanico R y EPS G Meccanico R expRendimiento realizados con ranuras de encaje. Para fijar mecánicamente mediante tacos SDK U.</p> |
| <p>Incidenza: 1,7 m/m² Lunghezza barre: 6 m</p> | <p>Incidence: 1.7 m/m² Bar Length: 6 m</p> | <p>Incidencia: 1,7 m/m² Largo de las barras: 6 m</p> |

profilo orizzontale PVC OR/LT

 scheda
 tecnica

| profili di ancoraggio orizzontali per cappotto meccanico | horizontal anchor profiles for mechanical external thermal insulation system | perfiles de anclaje horizontales para sistema por capas mecánico |
|--|--|--|
| <p>Profilo in PVC per il fissaggio orizzontale del sistema TermoK8 Meccanico atto a sostenere i pannelli EPS Meccanico R ed EPS G Meccanico R appositamente realizzati con scanalature ad incastro. Da fissare meccanicamente mediante tasselli SDK U.</p> | <p>PVC profile for horizontal fastening the TermoK8 mechanical system to support the specially designed EPS Meccanico R and EPS G Meccanico R panels with interlocking grooves. To be mechanically fastened using SDK U anchors.</p> | <p>Perfil en PVC para la fijación horizontal del sistema TermoK8 Mecánico, que permite sostener los paneles EPS Meccanico R y EPS G Meccanico R, expRendimiento realizados con ranuras de encaje. Para fijar mecánicamente mediante tacos SDK U.</p> |
| <p>Per sistema: TermoK8 Meccanico Lunghezza: 2,5 m Confezione: 20 pezzi = 50 m</p> | <p>For the system: TermoK8 Meccanico (mechanical) Length: 2.5 m Package: 20 pezzi = 50 m</p> | <p>Para sistema: TermoK8 Meccanico (mecánico) Largo: 2,5 m Envase: 20 piezas = 50 m</p> |

profilo verticale VR/LT



scheda
tecnica



| elementi di collegamento verticali per cappotto meccanico | vertical connection elements for mechanical external thermal insulation system | elementos de conexión verticales para sistema por capas mecánico |
|---|---|---|
| <p>Profilo estruso in lega d'alluminio per il fissaggio verticale del sistema Termok8 Meccanico atto a connettere i pannelli EPS Meccanico R ed EPS G Meccanico R appositamente realizzati con scanalature ad incastro.</p> | <p>Extruded aluminium alloy profile for vertical fastening of the Termok8 mechanical system to connect the specially designed EPS Meccanico R and EPS G Meccanico R panels with interlocking grooves.</p> | <p>Perfil extruido en aleación de aluminio para la fijación vertical del sistema Termok8 Mecánico, que permite sostener los paneles EPS Meccanico R y EPS G Meccanico R. Rendientemente realizados con ranuras de encaje.</p> |
| <p>Per sistema Termok8: Meccanico Incidenza: 1,6 m/m² Lunghezza barre: 6 m</p> | <p>For the Termok8: mechanical system Incidence: 1.6 m/m² Bar Length: 6 m</p> | <p>Para sistema: Termok8 Mecánico Incidencia: 1,6 m/m² Largo de las barras: 6 m</p> |

profilo verticale PVC VR/LT



scheda
tecnica



| elementi di collegamento verticali per cappotto meccanico | vertical connection elements for mechanical external thermal insulation system | Hidroes elementos de conexión verticales para sistema por capas mecánico malte |
|--|--|---|
| <p>Profilo in PVC per il fissaggio verticale del sistema Termok8 Meccanico atto a connettere i pannelli EPS Meccanico R ed EPS G Meccanico R appositamente realizzati con scanalature ad incastro.</p> | <p>PVC profile for vertical fastening of the Termok8 mechanical system to connect the specially designed EPS Meccanico R and EPS G Meccanico R panels with interlocking grooves.</p> | <p>Perfil en PVC para la fijación vertical del sistema Termok8 Mecánico, que permite sostener los paneles EPS Meccanico R y EPS G Meccanico R realizados con ranuras de encaje.</p> |
| <p>Per sistema Termok8: Meccanico Lunghezza: 47 cm Confezione: 100 pezzi = 47 m</p> | <p>For the Termok8: mechanical system Length: 47 cm Package: 100 pezzi = 47 m</p> | <p>Para sistema: Termok8 Mecánico Largo: 47 cm Envase: 100 piezas = 47 m</p> |

profilo di base



| profilo di partenza in alluminio | base profile in aluminium | perfil inicial en aluminio |
|--|---|--|
| <p>Profilo di partenza ad U in alluminio naturale antialcalino o alluminio preverniciato, con gocciolatoio, per l'allineamento di partenza, la protezione ed il contenimento del sistema. Si consiglia l'uso del profilo "Rompigoccia per base di partenza" per evitare il rischio di cavillature nell'area della zoccolatura. Adatto a tutti i sistemi di isolamento termico.</p> | <p>U-shaped base profile in natural, anti-alkaline or pre-painted aluminium, with drip profile, for setting-out, protection and retention of the system. We recommend using the "Drip edge for base profile" profile to prevent the risk of cracking in the area around the building plinth. Suitable for all z thermal insulation systems.</p> | <p>Perfil inicial en U en aluminio natural antialcalino o aluminio prepintado, con gotero, para la alineación inicial, la protección y la contención del sistema. Se aconseja el uso del perfil "Rompegotas para base inicial" para evitar el riesgo de cuarteados en el área del rodapié. Idóneo para todos los sistemas de aislamiento térmico IVAS.</p> |
| <p>Perisolanti di spessore: da 3, a 16 cm (altri su richiesta) Lunghezza barre: 2,5 m Confezione: da 10 barre (tot 25 m)</p> | <p>For insulation thicknesses: from 3 to 16 cm (others available upon request) Bar Length: 2.5 m Package: 10 bars (total: 25 m)</p> | <p>Para aislantes de espesor: de 3 hasta 16 cm (otros bajo pedido) Largo de las barras: 2,5 m Envase: de 10 barras (tot 25 m)</p> |

profilo di base PVC-R



| profilo di partenza in pvc con elemento di chiusura | pvc base profile with closing element | perfil inicial en pvc con elemento de cierre |
|--|--|--|
| <p>Profilo di partenza ad L in pvc a taglio termico abbinato con un raccordo di chiusura variabile, provvisto di gocciolatoio, rete di risvolto ed elemento di connessione per ridurre il pericolo di cavillature nell'area della zoccolatura. Il profilo ad L di partenza, viene fornito in due misure per poter coprire isolamenti di spessore variabile da 10 a 24 cm. Adatto a tutti i sistemi di isolamento termico IVAS.</p> | <p>L-shaped PVC base thermal break profile combined with variable end fitting, equipped with a drip profile, mesh side and connection element to reduce the risk of cracking in the area of the building plinth. The L-shaped base profile comes in two sizes to cover insulation thicknesses ranging from 8 to 24 cm. Suitable for all IVAS thermal insulation systems.</p> | <p>Perfil inicial en L en pvc de corte térmico con unión de cierre variable, dotado de gotero, malla remetida y elemento de conexión para reducir el peligro de cuarteados en el área del rodapié. El perfil inicial en L se entrega en dos medidas para poder cubrir aislamientos de espesor variable de 8 a 24 cm. Idóneo para todos los sistemas de aislamiento térmico IVAS.</p> |
| <p>Lunghezza barre: 2 m Confezione: da 10 barre (tot 20 m)</p> | <p>Bar Length: 2 m Package: 10 bars (total: 20 m)</p> | <p>Largo de las barras: 2 m Envase: de 10 barras (tot 20 m)</p> |

 scheda
 tecnica

rompigoccia per base di partenza-R

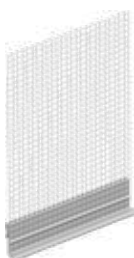

| profilo di raccordo con il profilo di partenza | connection profile with the base profile | perfil de conexión con el perfil inicial |
|--|--|---|
| <p>Profilo in PVC con gocciolatoio e rete in fibra di vetro termosaldato per aggancio al profilo di base partenza. Riduce il pericolo di cavillature del rivestimento nella congiunzione dei profili di base-partenza.</p> | <p>PVC profile with drip edge and heat-sealed glass fibre mesh for bonding to the base profile. Reduces the risk of cracks in the coating at base profiles' connection points.</p> | <p>Perfil en PVC con gotero y malla en fibra de vidrio termosellada para el enganche al perfil de base inicial. Reduce el peligro de cuarteados del revestimiento en la unión de los perfiles de base-inicio.</p> |
| <p>Lunghezza barre: 2 m Confezione: 25 barre (tot 50 m)</p> | <p>Bar Length: 2 m Package: 25 bars (total: 50 m)</p> | <p>Largo de las barras: 2 m Envase: 25 barras (tot 50 m)</p> |

 scheda
 tecnica

paraspigolo angolare AL



| profilo angolare di protezione in alluminio | aluminium corner bead profile | perfil angular de protección en aluminio |
|--|---|--|
| <p>Profilo angolare in alluminio per il rinforzo e la protezione di tutti gli angoli, spigoli e stipiti ad angolo retto di finestre o porte.</p> | <p>Aluminium corner bead profile to reinforce and protect all corners, edges and right-angled window or door jambs.</p> | <p>Perfil angular en aluminio para el refuerzo y la protección de todos los ángulos, aristas y marcos en ángulo recto de ventanas o puertas.</p> |
| <p>Lunghezza barre: 2,5 m Confezione: da 50 barre (tot 125 m)</p> | <p>Bar Length: 2.5 m Package: 50 bars (total: 125 m)</p> | <p>Largo de las barras: 2,5 m Envase: de 50 barras (tot 125 m)</p> |

 scheda
 tecnica

paraspigolo angolare AL-R



scheda
tecnica

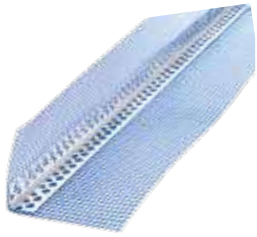

| | | |
|--|--|--|
| profilo angolare di protezione in alluminio con rete | aluminium corner bead profile with mesh | perfil angular de protección en aluminio con malla |
| Profilo angolare in alluminio per il rinforzo e la protezione di tutti gli angoli, spigoli e stipiti ad angolo retto di finestre o porte con rete in fibra di vetro incorporata. | Aluminium corner bead profile with built-in glass fibre mesh designed to reinforce and protect all corners, edges and right-angled window or door jambs. | Perfil angular en aluminio para el refuerzo y la protección de todos los ángulos, aristas y marcos en ángulo recto de ventanas o puertas con malla de fibra de vidrio incorporada. |
| Misura barre: 8 cm x 12 cm x 2,5 m Confezione: da 50 barre (tot 125 m) | Bar sizes: 8 cm x 12 cm x 2,5 m Package: 50 bars (total: 125 m) | Medidas de las barras: 8 cm x 12 cm x 2,5 m Envase: de 50 barras (tot 125 m) |

paraspigolo angolare PVC



| | | |
|---|--|--|
| profilo angolare di protezione in pvc | pvc corner bead profile | perfil angular de protección en pvc |
| Profilo angolare in PVC per il rinforzo e la protezione di tutti gli angoli, spigoli e stipiti ad angolo retto di finestre o porte. | PVC corner bead profile to reinforce and protect all corners, edges and right-angled window or door jambs. | Perfil angular en PVC para el refuerzo y la protección de todos los ángulos, aristas y marcos en ángulo recto de ventanas o puertas. |
| Lunghezza barre: 2,5 m Confezione: da 50 barre (tot 125 m) | Bar Length: 2.5 m Package: 50 bars (total: 125 m) | Largo de las barras: 2,5 m Envase: de 50 barras (tot 125 m) |

paraspigolo angolare PVC-R



scheda
tecnica



| | | |
|---|---|---|
| profilo angolare di protezione in pvc con rete | pvc corner bead profile with mesh | perfil angular de protección en pvc con malla |
| Profilo angolare in PVC per il rinforzo e la protezione di tutti gli angoli, spigoli e stipiti ad angolo retto di finestre o porte con rete in fibra di vetro incorporata. | PVC corner bead profile with built-in glass fibre mesh designed to reinforce and protect all corners, edges and right-angled window or door jambs. | Perfil angular en PVC para el refuerzo y la protección de todos los ángulos, aristas y marcos en ángulo recto de ventanas o puertas con malla de fibra de vidrio incorporada. |
| Lunghezza barre: 2,5 m Altezza lati angolare: 22 x 22mm Altezza rete: 80x120mm Confezione: da 50 barre (tot 125 m) Su richiesta altre dimensioni fino a 300mm | Bar Length: 2.5 m Profile sides height: 22 x 22mm Mesh height: 80x120mm Package: 50 bars (total: 125 m) Other sizes of up to 300mm available upon request | Largo de las barras: 2,5 m Altura de los lados del angular: 22x22 mm Altura de la malla: 80X120 mm Envase: de 50 barras (tot 125 m) Bajo pedido, otras medidas hasta 300 mm |

paraspigolo angolare archi PVC



| | | |
|---|--|---|
| profilo angolare di protezione archi in pvc | pvc corner bead profile for archways | perfil angular de protección de arcos en pvc |
| Profilo angolare in PVC per il rinforzo e la protezione di tutti gli archi. Flessibile e modellabile. | PVC corner bead profile to reinforce and protect all archways. Flexible and mouldable. | Perfil angular en PVC para el refuerzo y protección de todos los arcos. Flexible y modelable. |
| Lunghezza barre: 3 m | Bar Length: 3 m | Largo de las barras: 3 m |

paraspigolo angolare flex PVC-R



| | | |
|--|---|---|
| profilo angolare di protezione in pvc ad angolo variabile | pvc corner bead profile with variable angle | perfil angular de protección en pvc en ángulo variable |
| Profilo angolare in PVC a rotolo, per il rinforzo e la protezione di tutti gli angoli, spigoli e stipiti ad angolo variabile di finestre o porte con rete in fibra di vetro incorporata. | Roll of PVC corner bead profile with built-in glass fibre mesh designed to reinforce and protect all corners, edges and variable-angled window or door jambs. | Perfil angular en PVC en rollo, para el refuerzo y protección de todos los ángulos, aristas y marcos en ángulo variable de ventanas o puertas con malla en fibra de vidrio incorporada. |
| Lunghezza rotolo: 25 m (1 rotolo in una scatola) | Roll Length: 25 m (1 roll in a box) | Largo del rotolo: 25 m (1 rotolo en una caja) |

profilo con gocciolatoio PVC-R



| | | |
|--|--|--|
| profilo angolare con gocciolatoio e rete | corner bead profile with drip edge and mesh | perfil angular con gotero y malla |
| Profilo in PVC con rete in fibra di vetro incorporata e gocciolatoio per l'esecuzione di angoli su facciate rientranti, solai su spazi aperti (piani Pilotys), vani finestre e porte, cassette per avvolgibili, balconi ecc. | PVC profile with built-in glass fibre mesh and drip edge designed to prepare corners on recessed façades, floors in open spaces (Pilotys floors), window and door openings, roller shutter boxes, balconies etc. | Perfil en PVC con malla en fibra de vidrio incorporada y gotero para la ejecución de ángulos en fachadas entrantes, forjados en espacios abiertos (plantas bajas diáfanos con pilares), huecos de ventanas y puertas, cajas para enrollables, balcones, etc. |
| Lunghezza barre: 2,5 m Confezione: da 25 barre (tot 62,5 m) | Bar Length: 2.5 m Package: 25 bars (total: 62.5 m) | Largo de las barras: 2,5 m Envase: de 25 barras (tot 62,5 m) |

profilo SD sottodavanzale

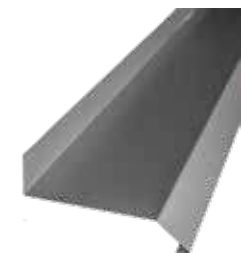

| | | |
|---|--|---|
| profilo in alluminio sottodavanzale | aluminium undersill profile | perfil en aluminio para debajo del alféizar |
| Profilato in lega d'alluminio naturale, antialcalino, per la chiusura e la protezione meccanica del sistema Termok8 sotto i davanzali esistenti. Dotato di gocciolatoio. Sovraverniciabile. | Profile in antialkaline, natural aluminium alloy designed for closure and mechanical protection of Termok8 insulation systems under existing window sills. Equipped with drip edge. It can be overpainted. | Perfil en aleación de aluminio natural, antialcalino, para cierre y protección mecánica del sistema Termok8 bajo los alféizares existentes. Dotado de gotero. Admite recubrimiento con pintura. |
| Lunghezza barre: 2,5 m Eventuale confezione: 10 barre (totale 25 m) | Bar Length: 2.5 m Package: 10 bars (total: 25 m) | Largo de las barras: 2,5 m Envase (en su caso): 10 barras (total 25 m) |

profilo finestre PVC-R



| | | |
|---|--|--|
| profilo di raccordo a finestra con rete | window connection profile with mesh | perfil de conexión a ventana con malla |
| Profilo autoadesivo in PVC per il collegamento del sistema ai telai dei serramenti, preaccoppiato con rete in fibra di vetro incorporata. | Self-adhesive PVC profile pre-coupled with glass fibre mesh for connecting the system to window and door frames. | Perfil autoadhesivo en PVC para la conexión del sistema a los bastidores de los cierres, prelamado con malla en fibra de vidrio incorporada. |
| Lunghezza barre: 2,4 m Confezione: da 30 barre (tot 72 m) | Bar Length: 2.4 m Package: 30 bars (total: 72 m) | Largo de las barras: 2,4 m Envase: de 30 barras (tot 72 m) |



scheda
tecnica

profilo finestre plus PVC-R



scheda
tecnica



| profilo di raccordo a finestra con rete | window connection profile with mesh | perfil de conexión a ventana con malla |
|---|---|--|
| <p>Profilo in PVC per il raccordo a tenuta d'acqua battente tra il sistema a cappotto e i telai dei serramenti, in classe 1, con nastro autoadesivo, guarnizione sigillante in PE e rete in fibra di vetro termosaldada. Dotato di una guarnizione flessibile per la compensazione di piccoli movimenti (monodimensionali).</p> | <p>PVC profile for watertight connection between external thermal insulation systems and window and door frames, class 1, with self-adhesive tape, PE seal and heat-sealed glass fibre mesh. Equipped with a flexible seal to compensate for minor (one-dimensional) movements.</p> | <p>Perfil en PVC para unión estanca a la incidencia de la lluvia entre el sistema por capas y los bastidores de los cierres, en clase 1, con cinta autoadhesiva, junta de sellado en PE y malla en fibra de vidrio termosellada. Dotado de una junta flexible para compensar pequeños movimientos (monodimensionales).</p> |
| <p>Lunghezza barre: 2,4 m Confezione: da 30 barre (tot 72 m)</p> | <p>Bar Length: 2.4 m Package: 30 bars (total: 72 m)</p> | <p>Largo de las barras: 2,4 m Envase: de 30 barras (tot 72 m)</p> |

profilo finestre plus 3d PVC-R



scheda
tecnica



| profilo di raccordo a finestra con rete | window connection profile with mesh | perfil de conexión a ventana con malla |
|--|--|---|
| <p>Profilo in PVC per il raccordo a tenuta d'acqua battente tra il sistema a cappotto e i telai dei serramenti, in classe 3, con nastro autoadesivo, guarnizione sigillante in PE e rete in fibra di vetro termosaldada. Dotato di una guarnizione flessibile per la compensazione di grandi movimenti (tridimensionali)</p> | <p>PVC profile for watertight connection between external thermal insulation systems and window and door frames, class 3, with self-adhesive tape, PE seal and heat-sealed glass fibre mesh. Equipped with a flexible seal to compensate for large (three-dimensional) movements</p> | <p>Perfil en PVC para unión estanca a la incidencia de la lluvia entre el sistema por capas y los bastidores de los cierres, en clase 3, con cinta autoadhesiva, junta de sellado en PE y malla en fibra de vidrio termosellada. Dotado de una junta flexible para compensar grandes movimientos (tridimensionales)</p> |
| <p>Lunghezza barre: 2,4 m Confezione: da 25 barre (tot 60 m)</p> | <p>Bar Length: 2.4 m Package: 25 bars (total: 60 m)</p> | <p>Largo de las barras: 2,4 m Envase: de 25 barras (tot 60 m)</p> |

terminale per sottotetto PVC-R



scheda
tecnica



| profilo di raccordo al sottotetto | profile for connection to roofing beam structure | perfil de conexión al desván |
|--|--|--|
| <p>Profilo di collegamento del sistema alla struttura del sottotetto, per garantire l'aerazione del sottotetto o la ventilazione del tetto ventilato, realizzato con un corpo rigido parainsetti in PVC e rete in fibra di vetro termosaldada.</p> | <p>Profile connecting the system to the roofing beam structure, to ensure ventilation of the roofing beam structure or ventilated roof, made of a rigid, insect-resistant PVC body and heat-sealed glass fibre mesh.</p> | <p>Perfil de conexión del sistema a la estructura del desván, para garantizar la ventilación de este o la ventilación del techo ventilado, realizado con un cuerpo rígido antiinsectos en PVC y malla en fibra de vidrio termosellada.</p> |
| <p>Misure: 5,5x200 cm Eventuale confezione: 25 barre (50 m)</p> | <p>Size: 5.5x200 cm Package: 25 bars (total: 50 m)</p> | <p>Medidas: 5,5x200 cm Envase (en su caso): 25 barras (50 m)</p> |

profilo di collegamento PVC-R



scheda
tecnica



| profilo di raccordo a lamiera | profile for connection to sheet metal | perfil de conexión a chapa |
|---|---|---|
| <p>Profilo in PVC per il raccordo del sistema con scossaline, davanzali o altri elementi metallici, preaccoppiato con rete in fibra di vetro. Il profilo è dotato di un grembiule flessibile utile a consentire i movimenti differenziali degli elementi metallici collegati al sistema di isolamento a cappotto, garantendo un collegamento elastico ed una tenuta impermeabile fra intonaco e parti in lamiera.</p> | <p>PVC profile pre-coupled with glass fibre mesh designed to connect the system to flashings, window sills, or other metal elements. The profile is equipped with a flexible apron to allow differential movements of the metal elements connected to the external thermal insulation system, guaranteeing an elastic connection and an impermeable seal between plaster and sheet metal parts.</p> | <p>Perfil en PVC para la unión del sistema con cubrejuntas, alféizares u otros elementos metálicos, prelaminado con malla de fibra de vidrio. El perfil está dotado de un elemento flexible útil para permitir los movimientos diferenciales de los elementos metálicos conectados al sistema de aislamiento por capas, garantizando así una conexión elástica y un ajuste impermeable entre enfoscado y piezas de chapa.</p> |
| <p>Lunghezza barre: 2 m Confezione: da 25 barre (tot 50 m)</p> | <p>Bar Length: 2 m Package: 25 bars (total: 50 m)</p> | <p>Largo de las barras: 2 m Envase: de 25 barras (tot 50 m)</p> |

 scheda
 tecnica

profilo di chiusura PVC-R

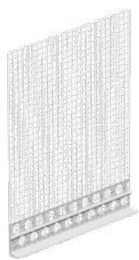

| profilo di chiusura per rivestimenti di finitura a spessore | closing profile for thick finishing coats | perfil de cierre para revestimientos de acabado de espesor |
|---|--|--|
| Il profilo di chiusura in PVC con rete permette di eseguire perfette chiusure di rivestimenti su sistemi di isolamento. Per un'interruzione a vista del sistema a cappotto, o per realizzare dei cambi di colore precisi e lineari. | The PVC closing profile with mesh ensures perfect closure of coatings on insulation systems. For a visible break in the external thermal insulation system or for precise, linear changes in colour. | El perfil de cierre en PVC con malla permite realizar cierres perfectos de los revestimientos sobre sistemas de aislamiento. Para una interrupción a la vista del sistema por capas, o para realizar cambios de color precisos y lineales. |
| Lunghezza barre: 2m Spessori disponibili: 3 mm, 6 mm, 8 mm, 10 mm Confezione: 25 pezzi (tot. 50 m) Altezza rete: 125 mm Grammatura rete: 160 g/m ² | Bar Length: 2m Available thicknesses: 3 mm, 6 mm, 8 mm, 10 mm Package: 25 pieces (total 50 m) Mesh height: 125 mm Mesh Weight: 160 g/m ² | Largo de las barras: 2m Espesores disponibles: 3 mm, 6 mm, 8 mm, 10 mm Envase: 25 piezas (tot. 50 m) Altura de la malla: 125 mm Gramaje de la malla: 160 g/m ² |

profilo CO di contenimento



| profilo di chiusura del sistema a cappotto | closing profile for external thermal insulation system | perfil de cierre del sistema por capas |
|--|---|--|
| Profilato in lega d'alluminio naturale, antialcalino, per la chiusura laterale e la protezione meccanica del sistema Termok8. Sovraverificabile. | Antialkaline, natural aluminium alloy profile for side closing and mechanical protection of the Termok8 insulation system. It can be overpainted. | Perfil en aleación de aluminio natural, antialcalino, para el cierre lateral y la protección mecánica del sistema Termok8. Admite recubrimiento con pintura. |
| Lunghezza barre: 2,5 m Eventuale confezione: 10 barre (totale 25 m) | Bar Length: 2.5 m Package: 10 bars (total: 25 m) | Largo de las barras: 2,5 m Envase (en su caso): 10 barras (total 25 m) |

profilo C di colmo



| profilo in alluminio chiusura giunto di separazione orizzontale | aluminium closing profile for horizontal separation joints | perfil en aluminio de cierre de junta de separación horizontal |
|--|--|---|
| Profilato in lega d'alluminio naturale, antialcalino, per la chiusura del giunto di separazione orizzontale del sistema Termok8 modulare big, nonché della tenuta d'acqua battente dello stesso. Obbligatorio nel sistema di Termok8 Modular Big. Spessore in funzione dell'isolante. Sovraverificabile. | Antialkaline, natural aluminium alloy profile for closing horizontal separation joints in the Termok8 modular big system and ensuring its water tightness. Required in the Termok8 Modular Big system. Thickness depending on insulation. It can be overpainted. | Profilado en aleación de aluminio natural, antialcalino, para el cierre de la junta de separación horizontal del sistema Termok8 modulare big, así como del sello estanco contra la incidencia de la lluvia. Obligatorio en el sistema de Termok8 Modular Big. Espesor en función del aislante. Admite recubrimiento con pintura. |
| Lunghezza barre: 2,5 m Eventuale confezione: 10 barre (totale 25 m) | Bar Length: 2.5 m Package: 10 bars (total: 25 m) | Largo de las barras: 2,5 m Envase (en su caso): 10 barras (total 25 m) |

profilo per rivestimenti modulari



| | | |
|--|---|---|
| profilo in alluminio a L di chiusuragiunto di separazione orizzontale | aluminium L-shaped closing profile for horizontal separation joints | perfil en aluminio en L de cierre de junta de separación horizontal |
| Profilato a "L" in lega d'alluminio naturale, antialcalino, per l'interruzione del sistema e la distribuzione dei carichi con rivestimenti modulari di piccole dimensioni. Obbligatorio nei sistemi di TermoK8 Modular D e TermoK8 Facciavista. Spessore in funzione dell'isolante. Sovraverniciabile. | L-shaped profile in antialkaline, natural aluminium alloy, designed for creating gaps in the system and to distribute the loads with small modular cladding. Required in the TermoK8 Modular D and TermoK8 Facciavista systems. Thickness depending on insulation. It can be overpainted. | Perfilado en "L" en aleación de aluminio natural, antialcalino, para la interrupción del sistema y la distribución de las cargas con revestimientos modulares de pequeño tamaño. Obligatorio en los sistemas de TermoK8 Modular D y TermoK8 Facciavista. Espesor en función del aislante. Admite recubrimiento con pintura. |
| Lunghezza barre: 2,5 m | Bar Length: 2.5 m | Largo de las barras: 2,5 m |

nastro autoespandente sigillante BG1



scheda
tecnica



| | | |
|--|--|--|
| nastro di guarnizione di interfaccia tra cappotto ed elementi | tape for interfacing seals between insulation system and elements | cinta para junta de interfaz entre sistema por capas y elementos |
| Nastro sigillante per giunti, autoadesivo, pre-compresso e pre-impregnato che soddisfa lo standard BG1. Sigillatura a tenuta stagna contro la pioggia battente ≥ 600 Pa di tutti i giunti di raccordo tra sistema di isolamento e finestre, davanzali, travi in legno etc, in edifici nuovi o ristrutturati. Permeabile al vapore, resistente ai raggi UV con eccellenti proprietà termiche e acustiche. Può essere esposto direttamente agli agenti atmosferici. Realizzato in PU espanso. | Self-adhesive, pre-compressed and pre-impregnated joint sealing tape compliant with BG1 standard. Waterproof sealing against driving rain ≥ 600 Pa for all joints between the insulation system and windows and doors, window sills, wooden beams etc. Ideal for both new or renovated buildings. Vapour permeable, UV-resistant with excellent thermal and acoustic properties. Can be directly exposed to the weather. Made of PU foam. | Cinta selladora para juntas, autoadhesiva, precomprimida y preimpregnada que cumple con el estándar BG1. Sellado estanco contra la incidencia de la lluvia a ≥ 600 Pa de todas las juntas de unión entre sistema de aislamiento y ventanas, alféizares, vigas de madera, etc., en edificios nuevos o reacondicionados. Permeable al vapor, resistente a los rayos UV con excelentes propiedades térmicas y acústicas. Puede exponerse directamente a los agentes atmosféricos. Realizado en PU expandido. |
| Colore nero. Misure rotolo: larghezza 15 mm; lunghezza 12 m Spessore: 2,0-6,0 mm Campo d'impiego: larghezza fuga 2 - 6 mm Misure rotolo: larghezza 15 mm; lunghezza 8 m Spessore: 6,0-15,0 mm Campo d'impiego: larghezza fuga 6-15 mm | Color: black. Roll Size: width 15 mm; length 12 m Thickness: 2.0-6.0 mm Usage range: joint widths of 2 - 6 mm Roll Size: width 15 mm; length 8 m Thickness: 6.0-15.0 mm Usage range: joint widths of 6 - 15 mm | Color negro. Medidas del rollo: ancho 15 mm, largo 12 m Espesor: 2,0-6,0 mm Campo de empleo: ancho de la junta 2 - 6 mm Medidas del rollo: ancho 15 mm, largo 8 m Espesor: 6,0-15,0 mm Campo de empleo: ancho de la junta 6 - 15 mm |

rete fuga decorativa

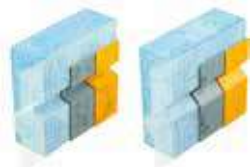
 scheda
 tecnica

| rete di armatura presagomata lineare per decori in facciata | shaped linear reinforcement mesh for façade decorations | mallà de armadura preformada lineal para decoraciones en fachada |
|--|---|---|
| Rete di vetro apprettata, antidemagliante, resistente agli alcali, pre-sagomata per l'esecuzione di scanalature orizzontali o verticali su intonaco e su pannelli isolanti con fuga predisposta. | Sized, unravel-proof mesh resistant to alkalis, shaped for making horizontal or vertical grooves in plaster and insulating panels with prepared joints. | Malla de vidrio aprestada, antidesmallante, resistente a los álcalis, preformada para la ejecución de acanaladuras horizontales o verticales en enfoscados y sobre paneles aislantes con junta preparada previamente. |
| Tipo 1 (trapezio stretta): 30x20x17 mm Tipo 2 (trapezio larga): 37x20x17 mm Tipo 3 (triangolare): 30x0x17 mm Lunghezza profilo: 200 cm Confezione: 10 pezzi | Type 1: 30x20x17 mm Type 2: 37x20x17 mm Type 3: 30x0x17 mm Profile Length: 200 cm Package: 10 pieces | Tipo 1: 30x20x17 mm Tipo 2: 37x20x17 mm Tipo 3: 30x0x17 mm Largo del perfil: 200 cm Envase: 10 piezas |

rete fuga decorativa angolo esterno



| rete di armatura presagomata al angolo esterno per decori in facciata | shaped reinforcement mesh for outer façade corner decorations | mallà de armadura preformada en el ángulo exterior para decoraciones de fachada |
|---|---|---|
| Rete di vetro apprettata, antidemagliante, resistente agli alcali, presagomata per l'esecuzione di scanalature ad angolo esterno su intonaco e su pannelli isolanti con fuga predisposta. | Sized, unravel-proof mesh resistant to alkalis, shaped for making outer corner grooves in plaster and insulating panels with prepared joints. | Malla de vidrio aprestada, antidesmallante, resistente a los álcalis, preformada para la ejecución de acanaladuras de ángulo externo en enfoscados y sobre paneles aislantes con junta preparada previamente. |
| Tipo 1 (trapezoidale stretta) 30x20x17mm Tipo 2 (trapezoidale larga) 37x20x17mm Tipo 3 (triangolare) 30x0x17mm Confezione: 10 pz | Type 1: 30x20x17 mm Type 2: 37x20x17 mm Type 3: 30x0x17 mm Package: 10 pcs | Tipo 1: 30x20x17 mm Tipo 2: 37x20x17 mm Tipo 3: 30x0x17 mm Envase: 10 piezas |

rete fuga decorativa angolo interno



| rete di armatura presagomata ad angolo interno per decori in facciata | shaped reinforcement mesh for internal façade corner decorations | mallà de armadura preformada de ángulo interior para decoraciones en fachada |
|---|--|--|
| Rete di vetro apprettata, antidemagliante, resistente agli alcali, presagomata per l'esecuzione di scanalature ad angolo interno su intonaco e su pannelli isolanti con fuga predisposta. | Sized, unravel-proof mesh resistant to alkalis, shaped for making internal corner grooves in plaster and insulating panels with prepared joints. | Hidroe Malla de vidrio aprestada, antidesmallante, resistente a los álcalis, preformada para la ejecución de acanaladuras en ángulo interior sobre enfoscados y sobre paneles aislantes con junta preparada previamente. |
| Tipo 1 (trapezio stretta) 30x20x17mm Tipo 2 (trapezio larga) 37x20x17mm Tipo 3 (triangolo) 30x0x17mm Confezione: 10 pz | Type 1: 30x20x17 mm Type 2: 37x20x17 mm Type 3: 30x0x17 mm Package: 10 pcs | Tipo 1: 30x20x17 mm Tipo 2: 37x20x17 mm Tipo 3: 30x0x17 mm Envase: 10 piezas |

profilo di giunto semplice GL-R



scheda
tecnica



| profilo giunto di dilatazione lineare | corner expansion joint profile | perfil junta de dilatación angular |
|--|--|---|
| <p>Profilo per giunti di dilatazione su superfici piane (180°) sul sistema di isolamento termico, realizzato con nastro di tenuta flessibile, preaccoppiato con rete in fibra di vetro. Per ampiezze massime del giunto di 5-25 mm. Con possibilità di acquisto dell'elemento di copertura estetico.</p> | <p>Profile for expansion joints on orthogonal surfaces (90°) on thermal insulation systems, made of flexible sealing tape, pre-coupled with glass fibre mesh. For maximum joint widths of 5-25 mm. Aesthetic covering element available.</p> | <p>Perfil para juntas de dilatación sobre superficies ortogonales (90°) en el sistema de aislamiento térmico, realizado con cinta de ajuste flexible, prelaminado con malla de fibra de vidrio. Para anchuras máximas de la junta de 5-25 mm. Con posibilidad de compra del elemento de cobertura estético.</p> |
| <p>Lunghezza barre: 2,5 m Eventuale confezione: 25 barre (tot. 62,5 m)</p> | <p>Bar Length: 2.5 m Package: 25 bars (total: 62.5 m)</p> | <p>Largo de las barras: 2,5 m Envase (en su caso): 25 barras (total 62,5 m)</p> |

profilo di giunto semplice GA-R



scheda
tecnica



| profilo giunto di dilatazione angolare | linear expansion joint profile | perfil junta de dilatación lineal |
|--|---|---|
| <p>Profilo per giunti di dilatazione su superfici ortogonali (90°) sul sistema di isolamento termico, realizzato con nastro di tenuta flessibile, preaccoppiato con rete in fibra di vetro. Per ampiezze massime del giunto di 5-25 mm. Con possibilità di acquisto dell'elemento di copertura estetico.</p> | <p>Profile for expansion joints on flat surfaces (180°) on thermal insulation systems, made of flexible sealing tape, pre-coupled with glass fibre mesh. For maximum joint widths of 5-25 mm. Aesthetic covering element available.</p> | <p>Perfil para juntas de dilatación sobre superficies planas (180°) en el sistema de aislamiento térmico, realizado con cinta de ajuste flexible, prelaminado con malla de fibra de vidrio. Para anchuras máximas de la junta de 5-25 mm. Con posibilidad de compra del elemento de cobertura estético.</p> |
| <p>Lunghezza barre: 2,5 m Eventuale confezione: 25 barre (tot. 62,5 m)</p> | <p>Bar Length: 2.5 m Package: 25 bars (total: 62.5 m)</p> | <p>Largo de las barras: 2,5 m Envase (en su caso): 25 barras (total 62,5 m)</p> |

giunto di dilatazione plus PVC-R



scheda
tecnica



| profilo di giunto di dilatazione di piccoli movimenti | expansion joint profile for minor movements | perfil de junta de dilatación de pequeños movimientos |
|---|---|--|
| <p>Profilo giunto di dilatazione in PVC per garantire il contenimento di piccoli movimenti, realizzato con coprigiunto centrale e rete in fibra di vetro termosaldata. Favorisce l'assorbimento dei movimenti strutturali di assestamento nelle pareti continue. Utilizzato anche come raccordo tra i pannelli isolanti di diversa natura/tipologia. Funge anche da guida per la posa dell'intonaco e/o per l'applicazione di guaine liquide. Idoneo per raccordare il sistema a cappotto con rasature armate o per l'interruzione di rasatura armata e finitura.</p> | <p>PVC expansion joint profile to ensure containment of minor movements, made with central joint cover and heat-sealed glass fibre mesh. Helps absorb structural settling movements in curtain walls. Also used as connection between different types of insulation panels. Also serves as guide when laying plaster and/or liquid membranes. Suitable for connecting the external thermal insulation system with reinforced skim coats or for interrupting reinforced skim and topcoats.</p> | <p>Perfil junta de dilatación en PVC para garantizar la contención de pequeños movimientos, realizado con tapajunta central y malla de fibra de vidrio termosoldada. Favorece la absorción de los movimientos estructurales de ajuste en las paredes continuas. También se utiliza como conexión entre los paneles aislantes de diferente naturaleza/tipo. También sirve de guía para la colocación del yeso y/o para la aplicación de fundas líquidas. Apto para conectar el sistema a capa con afeitados armados o para la interrupción del afeitado armado y acabado.</p> |
| <p>Lunghezza barre: 2,5 m Eventuale confezione: 25 barre (tot. 62,5 m)</p> | <p>Size: height 7 mm, length 2.5 m Package: 25 bars (total: 62.5 m)</p> | <p>Medidas: altura 7 mm, largo 2,5 m Envase (en su caso): 25 barras (62,5 m)</p> |

kit montaggio profili di base



| | | |
|---|--|--|
| set per il fissaggio dei profili di partenza e guide | set for fastening base profiles and joints | set para la fijación de los perfiles iniciales y guías |
| Set per il montaggio idoneo al fissaggio di profili di partenza in sistemi ETICS | installation set suitable for fastening base profiles on ETICS systems | Set de montaje idóneo para la fijación de los perfiles iniciales en sistemas SATE |
| Composto da: 75 tasselli a percussione ND-K 6 x 60 10 elementi di giunzione PV 30 50 elementi di compensazione AS 3 | Composed of: 75 percussion anchors ND-K 6 x 60 10 joint elements PV 30 50 compensation elements AS 3 | Formado por: 75 tacos de percusión ND-K 6 x 60 10 elementos de unión PV 30 50 elementos de compensación AS 3 |

elementi di compensazione



| | | |
|---|--|--|
| distanziatori per profili di partenza e guide | spacers for base profiles and guides | separadores para perfiles iniciales y guías |
| Per la compensazione delle tolleranze di planarità della facciata nel montaggio dei profili di partenza o delle guide per i sistemi meccanici. Adattabili a diversi diametri di tassello ed accoppiabili per coprire le più svariate tolleranze. Ciascuno spessore ha una colorazione differente per un rapido riconoscimento in cantiere. | To compensate for tolerance in façade flatness during installation of base profiles or mechanical system guides. Can be adapted for various anchor diameters and coupled to cover a wide range of tolerances. To ensure easy recognition at the construction site, each thickness has a different colour. | Para la compensación de las tolerancias de planicidad de la fachada en el montaje de los perfiles de inicio o de las guías para los sistemas mecánicos. Adaptables a distintos diámetros de taco y acoplables para cubrir las más diversas tolerancias. Cada espesor tiene un color distinto para su rápido reconocimiento en obra. |

tassello di ancoraggio a spirale

 scheda
 tecnica

| | | |
|---|--|--|
| tassello di ancoraggio di carichi leggeri a cappotto ultimato | anchor for light loads after external thermal insulation system has been completed | taco de anclaje de cargas ligeras al sistema por capas terminado |
| Tassello in plastica a forma di spirale, con rondella di tenuta e alloggiamento interno filettato per una vite, per l'ancoraggio di oggetti leggeri su sistemi ETICS già intonacati (indipendente dallo spessore di isolamento), senza formazione di ponte termico. | Spiral-shaped plastic anchor with sealing washer and threaded inner housing for a screw, used to anchor lightweight objects on previously plastered ETICS systems (of any insulation thickness), without forming a thermal bridge. | Taco de plástico en forma de espiral, con arandela de ajuste y alojamiento interior roscado para un tornillo, para anclaje de objetos ligeros en sistemas ETICS ya enfoscados (independiente del espesor de aislamiento), sin formación de puente térmico. |
| Esempi di applicazione: numeri civici, casette postali piccole, lampade, punti luce, insegne leggere ecc. Portata consigliata: 5 kg Contenuto 1 scatola: 100 pezzi | Examples of Applications: house numbers, small mailboxes, lamps, spotlights, light-weight signs, etc. Recommended Weight: 5 kg Contents in 1 box: 100 pieces | Ejemplos de Aplicaciones: números urbanos, buzones postales pequeños, lámparas, puntos de luz, rótulos ligeros, etc. Capacidad aconsejada: 5 kg Contenido 1 caja: 100 piezas |

inserto dart-set



scheda
tecnica



| | | |
|---|--|---|
| <p>set fissaggio di carichi leggeri-medi a cappotto ultimato</p> | <p>set for fastening light and medium-weight loads after external thermal insulation system has been completed</p> | <p>set de fijación de cargas ligeras-medias a sistema por capas terminado</p> |
| <p>Elemento di fissaggio costituito da una boccia di montaggio in materiale plastico con guarnizione di tenuta in EPDM ed un tassello per facciata (Ø 8mm). Utilizzato per il montaggio di carichi non pianificati da leggeri a medi su sistemi ETICS già intonacati in EPS, lana minerale, senza formazione di ponte termico.</p> | <p>Fixing element consisting of a plastic mounting bush with EPDM sealing gasket and a dowel for the facade (Ø 8mm). Used for mounting light to medium unplanned loads on ETICS systems already plastered in EPS, mineral wool, without forming a thermal bridge.</p> | <p>Elemento de fijación compuesto por un casquillo de montaje de plástico con junta de estanqueidad de EPDM y un taco para la fachada (Ø 8 mm). Se utiliza para el montaje de cargas no planificadas de ligeras a medias sobre sistemas SATE ya revestidos de EPS, lana mineral, sin formar puente térmico.</p> |
| <p>Portata consigliata: 15 kg Diametro foro: 8 mm Profondità foratura: 80 mm Azionamento: Torx T30 Applicazione: staffe pluviali, ganci fermaimposte, cassette postali, lampade, punti luce, insegne, rilevatori di movimento ecc. Contenuto del kit: 10 Boccole - 10 Guarnizioni - 10 inserti per Ø 6 mm - 10 tasselli per facciata diametro 8 mm - 1 bit di montaggio</p> | <p>Recommended load: 15 kg Hole diameter: 8 mm Drilling depth: 80 mm Drive: Torx T30 Application: rain brackets, shutter hooks, mailboxes, lamps, lights, signs, motion detectors, etc. Kit contents: 10 Bushings - 10 Gaskets - 10 inserts for Ø 6 mm - 10 dowels for facade diameter 8 mm - 1 mounting bit</p> | <p>Capacidad aconsejada: 15 kg Diámetro del orificio: 8 mm Profundidad de perforación: 80 mm Accionamiento: Torx T30 Aplicación: soportes de lluvia, ganchos de persianas, buzones, lámparas, luces, letreiros, detectores de movimiento, etc. Contenido del kit: 10 casquillos - 10 juntas - 10 insertos para Ø 6 mm - 10 tacos para fachada Ø 8 mm - 1 punta de montaje</p> |

iso-bar



scheda
tecnica



| | | |
|---|---|---|
| <p>barra di fissaggio di carichi medi-pesanti a cappotto ultimato</p> | <p>fastening bar for medium to heavy loads after the external thermal insulation system has been completed</p> | <p>barra de fijación de cargas medias-pesadas a sistema por capas terminado</p> |
| <p>Barra in fibra di vetro con perno di montaggio in acciaio inox per il montaggio pianificato o non pianificato di carichi pesanti su sistemi ETICS già intonacati, senza formazione di ponte termico. Barra in fibra di vetro selezionabile a misura direttamente in cantiere. Certificazione dei valori di carico e di trasmittanza termica.</p> | <p>Glass fibre bar with stainless steel installation pin for both planned and unplanned installation of heavy loads on previously plastered ETICS systems without creating thermal bridges. Glass fibre bar, can be custom sized direCT Ly on site. Certification of load and thermal transmittance values.</p> | <p>Barra en fibra de vidrio con perno de montaje en acero inox para el montaje planificado o no planificado de cargas pesadas en sistemas ETICS ya enfoscados, sin formación de puente térmico. Barra en fibra de vidrio seleccionable a medida directamente en obra. Certificación de los valores de carga y de transmitancia térmica.</p> |
| <p>Applicazione: tende da sole, pensiline, climatizzatori, insegne, antenne paraboliche ecc. Contenuto del kit: 1 Iso-Bar, 1 boccia per il montaggio, 1 rondella con guarnizione di tenuta in EPDM, 1 dado M12 per il fissaggio di carico.</p> | <p>Examples of Applications: awnings, canopies, air conditioners, signs, satellite dishes, etc. Contents of the kit: 1 Iso-Bar, 1 installation bush, 1 washer with EPDM seal, 1 M12 nut to fasten load.</p> | <p>Ejemplos de Aplicaciones: toldos, marquesinas, climatizadores, rótulos, antenas parabólicas, etc. Contenido del kit: 1 Iso-Bar, 1 casquillo para el montaje, 1 arandela conjunta de ajuste en EPDM, 1 tuerca M12 para la fijación de carga.</p> |

cassetta elettrica Eldoline EPS

 scheda
 tecnica

| elemento in eps per il posizionamento di interruttori e punto luce | eps element for positioning switches and spotlights | elemento en eps para la colocación de interruptores y puntos de luz |
|--|--|--|
| <p>Cassetta elettrica isolante, costituita da una scatola e da quattro piedini realizzati in poliammide, applicati in uno stampato in EPS, idonea per il fissaggio sicuro dei componenti elettrici. Le alimentazioni cavi o tubi sono chiuse con dei tappini ciechi in EPS. Permette una installazione integrata al sistema ETICS facile ed efficiente. Garantisce l'assenza di ponte termico e la tenuta all'aria. Testate anche per il Blower Door Test.</p> | <p>Insulated electrical box, composed of a box and four polyamide feet, applied in moulded EPS unit suitable for safe securing of electrical components. The power supply cables or ducts are sealed with EPS blind plugs. Enables easy, efficient installation integrated with the ETICS system. Ensures that there are no thermal bridges and guarantees airtightness. Also tested for the Blower Door Test.</p> | <p>Caja eléctrica aislante, constituida por una caja y cuatro patas realizadas en poliamida, aplicadas en una estampación en EPS, idónea para la fijación segura de los componentes eléctricos. Las alimentaciones, cables o tubos, se cierran con tapones ciegos en EPS. Permite una instalación integrada en el sistema ETICS fácil y eficiente. Garantiza la ausencia de puente térmico y la estanqueidad al aire. Probadas también para el Blower Door Test.</p> |
| <p>Spessori disponibili: 80 - 300 mm Dimensioni: 150 x 150 mm Peso specifico EPS: 30 kg/m³ Inserto: Vimark 503 - V71303 Resistenza al fuoco: GW 650 °C Conducibilità termica: = 0.031 W/mK</p> | <p>Available thicknesses: 80 - 300 mm Size: 150 x 150 mm EPS Specific Weight: 30 kg/m³ Insert: Vimark 503 - V71303 Fire resistance: GW 650 °C Thermal conductivity: = 0.031 W/mK</p> | <p>Espesores disponibles: 80 - 300 mm Medidas: 150 x 150 mm Peso específico EPS: 30 kg/m³ Inserto: Vimark 503 - V71303 Resistencia al fuego: GW 650 °C Conductividad térmica: = 0.031 W/mK</p> |

inserto di rinforzo Quadroline

 scheda
 tecnica

| cubo di montaggio in eps per l'applicazione di carichi medi | eps mounting cube for applying medium loads | cubo de montaje en eps para la aplicación de cargas medias |
|--|--|--|
| <p>Cubo di fissaggio in EPS ad alta densità per il fissaggio di carichi leggeri e medi nei sistemi ETICS senza formazione di ponte termico. Funge inoltre da spessore di appoggio in caso di carichi intermedi.</p> | <p>Fastening cube made of high density EPS for fastening light and medium loads in ETICS systems without forming a thermal bridge. It also acts as a support shim for intermediate loads.</p> | <p>Cubo de fijación en EPS de alta densidad para la fijación de cargas ligeras y medias en los sistemas ETICS sin formación de puente térmico. Hace además de espesor de apoyo en caso de cargas intermedias.</p> |
| <p>Spessori disponibili: 60 - 300 mm Dimensione: 100 x 100 mm Peso specifico: 170 kg/m³ Conducibilità termica: = 0,051 W/mK Portata consigliata: 15 kg per elemento Applicazioni: gronde, luci da esterno, allarmi, telecamere, etc... Certificazione dei valori di carico e di trasmittanza.</p> | <p>Available thicknesses: 60 - 300 mm Size: 100 x 100 mm Specific Weight: 170 kg/m³ Thermal conductivity: = 0.051 W/mK Recommended weight: 15 kg per element Applications: gutters, outdoor lights, alarms, cameras, etc... Certification of load and transmittance values.</p> | <p>Espesores disponibles: 60 - 300 mm Medidas: 100 x 100 mm Peso específico: 170 kg/m³ Conductividad térmica: = 0,051 W/mK Capacidad aconsejada: 15 kg por elemento Aplicaciones: canaletas, luces de exterior, alarmas, cámaras de vídeo, etc... Certificación de los valores de carga y de transmitancia.</p> |

barra di fissaggio Vari Q

 scheda
 tecnica

| barra sezionabile in eps per l'applicazione di carichi medi | eps bar, divisible in sections, for applying medium loads | barra seccionable en eps para la aplicación de cargas medias |
|---|--|--|
| <p>Barra di fissaggio in EPS sezionabile multi spessore ad alta densità per il fissaggio di carichi leggeri e medi nei sistemi ETICS senza formazione di ponte termico. Funge inoltre da spessore di appoggio in caso di carichi intermedi.</p> | <p>Divisible, multi-thickness fastening bar of high-density EPS for fastening light and medium-weight loads in ETICS systems without forming a thermal bridge. It also acts as a support shim for intermediate loads.</p> | <p>Barra de fijación en EPS seccionable, multiespesor de alta densidad para la fijación de cargas ligeras y medias en los sistemas ETICS sin formación de puente térmico. Hace además de espesor de apoyo en caso de cargas intermedias.</p> |
| <p>Dimensione: 100 x 100 x 1000 mm Peso specifico: 140 kg/m³ Conducibilità termica: = 0,047 W/mK Portata consigliata: 15 kg per elemento Applicazioni: gronde, luci da esterno, allarmi, telecamere, etc... Certificazione dei valori di carico e di trasmittanza.</p> | <p>Size: 100 x 100 x 1000 mm Specific Weight: 140 kg/m³ Thermal conductivity: = 0.047 W/mK Recommended weight: 15 kg per element Applications: gutters, outdoor lights, alarms, cameras, etc... Certification of load and transmittance values.</p> | <p>Medidas: 100 x 100 x 1000 mm Peso específico: 140 kg/m³ Conductividad térmica: = 0,047 W/mK Capacidad aconsejada: 15 kg por elemento Aplicaciones: canaletas, luces de exterior, alarmas, cámaras de vídeo, etc... Certificación de los valores de carga y de transmitancia.</p> |

supporto di fissaggio K1-PE



scheda
tecnica



| | | |
|--|---|---|
| <p>elemento di fissaggio di cardini e inferriate</p> <p>Elemento di fissaggio ad angolo in poliuretano con armatura in fibra di vetro e piedini di regolazione per il fissaggio di cardini/inferriate sui sistemi ETICS senza formazione di ponte termico.</p> <p>Dimensione: 240 x 125 mm Superficie utile: 108 x 48 mm Peso specifico: 350 kg/m³ Portata consigliata: 35 kg per elemento Applicazioni: cardini, persiane scorrevoli, inferriate Certificazione dei valori di carico e di trasmittanza.</p> | <p>fastening element for awnings, shelters and canopies</p> <p>Rectangular polyurethane plate with steel, aluminium and phenolic resin reinforcement for fastening very heavy loads in ETICS systems without forming a thermal bridge.</p> <p>Dimension: 240 x 125 mm Useful surface: 108 x 48 mm Specific weight: 350 kg / m³ Recommended load: 35 kg per element Applications: hinges, sliding shutters, railings Certification of load and transmittance values.</p> | <p>elemento de fijación de toldos, marquesinas y tejadillos</p> <p>Placa rectangular en poliuretano con armadura en acero, aluminio y resina fenólica para la fijación en los sistemas SATE de cargas muy pesadas sin formación de puente térmico.</p> <p>Dimensión: 240 x 125 mm Superficie útil: 108 x 48 mm Peso específico: 350 kg/m³ Carga recomendada: 35 kg por elemento Aplicaciones: bisagras, contraventanas correderas, barandillas Certificación de valores de carga y transmitancia.</p> |
|--|---|---|

piastra per carichi pesanti UMP-ALU-TR



scheda
tecnica



| | | |
|---|--|---|
| <p>elemento di fissaggio di tende da sole, pensiline e tettoie</p> <p>Piastra rettangolare in poliuretano con armatura in acciaio, alluminio e resina fenolica per il fissaggio nei sistemi ETICS di carichi molto pesanti senza formazione di ponte termico.</p> <p>Spessori disponibili: 80 - 300 mm Dimensione: 238 x 138 mm Superficie utile: 162 x 80 mm Peso specifico: 350 kg/m³ Portata consigliata: 900 kg per elemento Certificazione dei valori di carico e di trasmittanza.</p> | <p>fastening element for hinges and gratings</p> <p>Polyurethane corner fastening element with glass fibre reinforcement and adjusting feet for fastening hinges/gratings on ETICS systems without forming a thermal bridge.</p> <p>Available thicknesses: 80 - 300 mm Dimension: 238 x 138 mm Useful surface: 162 x 80 mm Specific weight: 350 kg / m³ Recommended load: 900 kg per element Certification of load and transmittance values.</p> | <p>elemento de fijación de goznes y rejas</p> <p>Elemento de fijación en ángulo en poliuretano con armadura en fibra de vidrio y patas de ajuste para la fijación de goznes/rejas en sistemas SATE sin formación de puente térmico.</p> <p>Espesores disponibles: 80 - 300 mm Dimensión: 238 x 138 mm Superficie útil: 162 x 80 mm Peso específico: 350 kg / m³ Carga recomendada: 900 kg por elemento Certificación de valores de carga y transmitancia.</p> |
|---|--|---|

| tecniche | certificazioni | proprietà | tecnologie |
|----------|----------------|-----------|------------|
| | | | |

supporto di fissaggio frontale TRA-WIK-ALU-RF



scheda
tecnica



| | | |
|--|---|---|
| <p>elemento di fissaggio frontale di cardini inferriate e parapetti</p> <p>Elementi di fissaggio ad angolo in poliuretano con armatura in acciaio, alluminio e resina fenolica per il fissaggio di cardini/inferriate/parapetti sui sistemi ETICS senza formazione di ponte termico sul fronte facciata.</p> <p>Spessori disponibili: 80 - 300 mm Dimensione: 280 x 125 mm Superficie utile: 97 x 45 mm Peso specifico: 350 kg/m³ Portata consigliata: 65 kg per elemento Applicazioni: cardini, persiane scorrevoli, inferriate Certificazione dei valori di carico e di trasmittanza.</p> | <p>frontal fastening element for hinges, gratings and parapets</p> <p>Polyurethane corner fastening elements with steel, aluminium and phenolic resin reinforcement for fastening hinges/gratings/parapets on ETICS systems without forming a thermal bridge in the façade.</p> <p>Available thicknesses: 80 - 300 mm Size: 280 x 125 mm Useful surface area: 97 x 45 mm Specific Weight: 350 kg/m³ Recommended weight: 65 kg per element Applications: hinges, sliding shutters, railings Certification of load and transmittance values.</p> | <p>elemento de fijación frontal de goznes, rejas y parapetos</p> <p>Elemento de fijación en ángulo en poliuretano con armadura en acero, aluminio y resina fenólica para la fijación de goznes/rejas/parapetos en sistemas SATE sin formación de puente térmico en el frente de fachada.</p> <p>Espesores disponibles: 80 - 300 mm Superficie útil: 97 x 45 mm Peso específico: 350 kg/m³ Capacidad aconsejada: 65 kg por elemento Aplicaciones: bisagras, contraventanas correderas, barandillas Certificación de los valores de carga y de transmitancia.</p> |
|--|---|---|

| tecniche | certificazioni | proprietà | tecnologie |
|----------|----------------|-----------|------------|
| | | | |

supporto di fissaggio laterale TRA-WIK-ALU-RL

 scheda
 tecnica

| elemento di fissaggio laterale di cardini inferriate e parapetti | side fastening element for hinges, gratings and parapets | elemento de fijación lateral de goznes, rejas y parapetos |
|--|--|--|
| Elementi di fissaggio ad angolo in poliuretano con armatura in acciaio, alluminio e resina fenolica per il fissaggio di inferriate e balconi alla francese sui sistemi ETICS senza formazione di ponte termico in imbotte finestra. | Polyurethane corner fastening elements with steel, aluminium and phenolic resin reinforcement for fastening French windows and balconies on ETICS systems without thermal bridging in the window intrados. | Elementos de fijación en ángulo en poliuretano con armadura en acero, aluminio y resina fenólica para la fijación de rejas y balcones franceses en sistemas ETICS sin formación de puente térmico en el intradós de la ventana. |
| Spessori disponibili: 80 – 300 mm Dimensione: 280 x 125 mm Superficie utile: 97 x 45 mm Peso specifico: 350 kg/m ³ Portata consigliata: 65 kg per elemento Resistenza in spinta: 200 Kg/ml in spinta secondo la norma per parapetti. Applicazioni: parapetti, cardini in imbotte, inferriate Certificazione dei valori di carico e di trasmittanza. | Available thicknesses: 80 – 300 mm Size: 280 x 125 mm Useful surface area: 97 x 45 mm Specific weight: 350 kg/m ³ Recommended weight: 65 kg per element Thrust resistance: 200 kg/ml in thrust according to the standard for parapets. Applications: parapets, hinges in intrados, railings Certification of load and transmittance values. | Espesores disponibles: 80 – 300 mm Medidas: 280 x 125 mm Superficie útil: 97 x 45 mm Peso específico: 350 kg/m ³ Capacidad aconsejada: 65 kg por elemento Resistencia en empuje: 200 Kg/ml en empuje según la norma para parapetos. Aplicaciones: antepechos, bisagras en intradós, barandillas Certificación de los valores de carga y de transmitancia. |

| tecniche | certificazioni | proprietà | tecnologie |
|----------|----------------|-----------|------------|
| | | | |

iso-corner

 scheda
 tecnica

| elemento di fissaggio di cardini e inferriate | fastening element for hinges and gratings | elemento de fijación de goznes y rejas |
|--|--|--|
| Consolle ad angolo in poliuretano ad alta densità, per il montaggio pianificato di carichi pesanti su sistemi ETICS senza formazione di ponte termico sul fronte facciata o in imbotte finestra. Selezionabile a misura direttamente in cantiere (anche in posa). | Corner console made of high-density polyurethane, for the planned installation of heavy loads on ETICS systems without forming a thermal bridge on the façade or in the window intrados. Can be selected to size direCT Ly on site (also on installation). | Consolas en ángulo en poliuretano de alta densidad, para el montaje planificado de cargas pensadas en sistemas ETICS sin formación de puente térmico en el frente de la fachada o en el intradós de la ventana. Seleccionable a medida directamente en obra (también en colocación). |
| Dimensione: 270 x 142,5 mm Superficie utile facciata: 100 x 10mm Superficie utile spalletta: 100 x Spessore Isocorner - 40mm Spessori disponibili: 14, 20, 30 cm Applicazioni: parapetti, cardini in imbotte, persiane scorrevoli, inferriate. Certificazione dei valori di carico | Size: 270 x 142.5 mm Useful surface area of the façade: 100 x 10mm Useful surface area of the reveal: 100 x Isocorner thickness - 40mm Available thicknesses: 14, 20, 30 cm Applications: parapets, hinges in intrados, sliding shutters, gratings. Certification of load values | Medidas: 270 x 142,5 mm Superficie útil de fachada: 100 x 10mm Superficie útil de la jamba: 100 x Espesor Isocorner - 40mm Espesores disponibles: 14, 20, 30 cm Aplicaciones: parapetos, goznes en intradós, persianas deslizantes, rejas. Certificación de los valores de carga |

| tecniche | certificazioni | proprietà | tecnologie |
|----------|----------------|-----------|------------|
| | | | |

iso-corner kit SDF



scheda
tecnica



| | | |
|--|--|---|
| <p>tasselli di fissaggio iso-corner su supporti A, B, C, D</p> <p>Set di tasselli per fissaggio su supporti in calcestruzzo (A), muratura piena (B), forata (C) o calcestruzzo alleggerito (D). Zona di espansione ottimizzata per una perfetta tenuta anche su materiali più problematici. Espansione radiale per una maggiore sicurezza di ancoraggio. Superficie della vite priva di cromo esavalente Cr(VI) Doppia alettatura di sicurezza antitorsione per un montaggio più sicuro</p> <p>Profondità di foratura: ≥ 80 mm Profondità di ancoraggio: ≥ 70 mm Diametro foratura: 10 mm</p> | <p>iso-corner anchors on A, B, C, D substrates</p> <p>Set of dowels for fastening to concrete (A), solid masonry (B), perforated masonry (C) or lightweight concrete (D). Optimised expansion zone for perfect sealing even on the most problematic materials. Radial expansion for greater anchorage security. Screw surface free of hexavalent chromium Cr(VI). Double anti-twist safety fins for safer mounting</p> <p>Drilling depth ≥ 80 mm Anchoring depth ≥ 70 mm Drilling Diameter: 10 mm</p> | <p>tacos de fijación iso-corner sobre soportes A, B, C, D</p> <p>Set de tacos para fijación en soportes de hormigón (A), paredes de ladrillo macizo (B), perforado (C) u hormigón aligerado (D). Zona de expansión optimizada para un perfecto ajuste incluso en los materiales más problemáticos. Expansión radial para una mayor seguridad de anclaje. Superficie del tornillo libre de cromo hexavalente Cr(VI) Sistema de dobles aletas de seguridad anti-torsión para un montaje más seguro</p> <p>Profundidad de perforación: ≥ 80 mm Profundidad de anclaje: ≥ 70 mm Diámetro de perforación: 10 mm</p> |
|--|--|---|

| tecniche | certificazioni | proprietà | tecnologie |
|----------|----------------|-----------|------------|
| | | | |

iso-corner kit SDP



scheda
tecnica



| | | |
|--|--|---|
| <p>tasselli di fissaggio iso-corner su supporti E</p> <p>Set di tasselli per fissaggio su supporti in CLS cellulare (E). Tasselli da facciata con vite a doppio diametro. Ancoraggio sicuro grazie alla zona di espansione combinata. Elevata capacità di carico.</p> <p>Profondità di foratura: ≥ 80 mm Profondità di ancoraggio: ≥ 70 mm Diametro foratura: 10 mm</p> | <p>anchors for fastening iso-corner on E substrates</p> <p>Set of dowels for fastening on cellular concrete substrates (E). Façade anchors with double-diameter screw. Safe anchoring thanks to the combined expansion zone. High load capacity.</p> <p>Drilling depth ≥ 80 mm Anchoring depth ≥ 70 mm Drilling Diameter: 10 mm</p> | <p>tacos de fijación iso-corner sobre soportes E</p> <p>Set de tacos para fijación sobre soportes en CLS celular (E). Tacos de fachada con tornillo de doble diámetro. Anclaje seguro gracias a la zona de expansión combinada. Alta capacidad de carga.</p> <p>Profundidad de perforación: ≥ 80 mm Profundidad de anclaje: ≥ 70 mm Diámetro de perforación: 10 mm</p> |
|--|--|---|

| tecniche | certificazioni | proprietà | tecnologie |
|----------|----------------|-----------|------------|
| | | | |

davanzali GFB

 scheda
 tecnica

| davanzale isolante prefinito | pre-finished insulating sill | alféizar aislante con acabado previo |
|---|--|---|
| <p>Davanzale isolante in GFB (cemento rinforzato in fibra di vetro) accoppiato con EPS ad alta densità 30 kg/m³, atto ad eliminare ponti termici in corrispondenza delle soglie delle finestre. Finitura verniciabile in cantiere. Utilizzabile sia su nuove costruzioni che ristrutturazioni.</p> | <p>GFB (glass-fibre reinforced concrete) insulating window sill coupled with 30 kg/m³ high density EPS, to eliminate thermal bridges at window sills. Finish can be painted on site. Can be used on both new buildings and renovations.</p> | <p>Alféizar aislante en GFB (cemento reforzado en fibra de vidrio) laminado con EPS de alta densidad 30 kg/m³, perfecto para eliminar puentes térmicos en los vanos de las ventanas. El acabado admite recubrimiento de pintura en obra. Utilizable tanto en nuevas construcciones como en reacondicionamientos.</p> |

davanzali ALU

 scheda
 tecnica

| davanzale in alluminio | aluminium window sill | alféizar en aluminio |
|--|---|--|
| <p>Davanzale in lega di alluminio 20/10 (sp. 2 mm) utilizzabile sia su nuove costruzioni che ristrutturazioni. Su richiesta verniciatura in produzione (solo tinte RAL).</p> | <p>Window sill made of 20/10 aluminium alloy (th. 2 mm) Can be used on both new buildings and renovations. Upon request, can be painted in production (only RAL colours).</p> | <p>Alféizar en aleación de aluminio 20/10 (esp. 2 mm) utilizable tanto en nuevas construcciones como en reacondicionamientos. Bajo pedido, pintado de fábrica (solo tintes RAL).</p> |



armatex C1

 scheda
tecnica

 data
sheet

 ficha
técnica

| rete di armatura 160 gr/m ² | reinforcement mesh - 160 g/m ² | malla de armadura 160 gr/m ² |
|--|--|---|
| <p>Rete di armatura in fibra di vetro apprettata, antidemagliante, resistente agli alcali, per sistemi di isolamento termico e in generale idonea per rasature armate con rasanti-colanti della gamma IVAS. Certificata come componente integrante del sistema di isolamento termico a cappotto. Dotato di omologazione secondo EAD 00416-00-0404</p> | <p>Sized, unravel-proof, glass fibre reinforcement mesh, resistant to alkalis, designed for thermal insulation systems and, in general, suitable for reinforced skimming with the IVAS line of adhesive-skim coats. Certified as an integral component of the external thermal insulation system. Certified according to EAD 00416-00-0404</p> | <p>Malla de armadura en fibra de vidrio apretada, antidesmallante, resistente a los álcalis, para sistemas de aislamiento térmico y en general idónea para enrasados armados con morteros de enrasado-colas de la gama IVAS. Certificada como componente integrante del sistema de aislamiento térmico por capas. Homologado según EAD 00416-00-0404</p> |
| <p>Colore: grigia con scala graduata per il montaggio. Categoria all'urto: I e II Resistenza all'urto: 3 Joule e fino a 10 Joule con EPS MAX Misure: 1,10 x 50 m per totali 55 m² Peso: 160 g/m² Resa (con le necessarie sovrapposizioni): 1,10 m² di rete per 1 m² di supporto</p> | <p>Colours available: grey with linear graduation for installation. Impact category I and II Impact resistance: 3 Joules and up to 10 Joules with EPS MAX Size: 1.10 x 50 m for a total of 55 m² Weight: 160 g/m² Coverage (with required overlapping): 1.10 m² of mesh per 1 m² of substrate</p> | <p>Gama de colores: gris con escala graduada para el montaje. Categoría de impacto: I y II Resistencia al impacto: 3 julios y hasta 10 julios con EPS MÁX Medidas: 1,10 x 50 m por un total de 55 m² Peso: 160 g/m² Rendimiento (con las necesarias superposiciones): 1,10 m² de malla por 1 m² de soporte</p> |

| tecniche | certificazioni | proprietà | tecnologie |
|----------|----------------|-----------|------------|
| | | | |

armatex C1R

 scheda
tecnica

 data
sheet

 ficha
técnica

| rete di armatura 380 gr/m ² | reinforcement mesh - 380 g/m ² | malla de armadura 380 gr/m ² |
|--|--|---|
| <p>Rete di armatura in fibra di vetro apprettata, antidemagliante, resistente agli alcali, apposta per migliorare la resistenza meccanica agli urti sui sistemi di isolamento a cappotto in particolare modo nella zona della zoccolatura. Certificata come componente integrante del sistema di isolamento termico a cappotto. Dotato di omologazione secondo EAD 00416-00-0404</p> | <p>Sized, unravel-proof, glass fibre reinforcement mesh, resistant to alkalis, designed to improve mechanical impact resistance on external thermal insulation systems, particularly in the area of building plinths. Certified as an integral component of the external thermal insulation system. Certified according to EAD 00416-00-0404</p> | <p>Malla de armadura en fibra de vidrio apretada, antidesmallante, resistente a los álcalis, idónea para mejorar la resistencia mecánica a los golpes en los sistemas de aislamiento por capas y en particular en la zona de rodapié. Certificada como componente integrante del sistema de aislamiento térmico por capas. Homologado según EAD 00416-00-0404</p> |
| <p>Colore: gialla Categoria all'urto: I Resistenza all'urto: 10 Joule Misure: 1 x 25 m per totali 25 m² Peso: 380 g/m² Resa (con le necessarie sovrapposizioni): 1,10 m² di rete per 1 m² di supporto</p> | <p>Color: yellow Impact category I Impact resistance: 10 Joule Size: 1 x 25 m for a total of 25 m² Weight: 380 g/m² Coverage: (with required overlapping) 1.10 m² of mesh per 1 m² of substrate</p> | <p>Color: amarilla Categoría de impacto: I Resistencia al impacto: 10 julios Medidas: 1 x 25 m por un total de 25 m² Peso: 380 g/m² Rendimiento: (con los solapamientos necesarios) 1,10 m² de malla por 1 m² de soporte</p> |

| tecniche | certificazioni | proprietà | tecnologie |
|----------|----------------|-----------|------------|
| | | | |

armatex C1 M



scheda
tecnica



data
sheet



ficha
técnica



| rete di armatura 225 gr/m ² | reinforcement mesh - 225 g/m ² | malla de armadura 225 gr/m ² |
|--|---|---|
| <p>Rete di armatura in fibra di vetro apprettata, antidemagliante, resistente agli alcali, per sistemi di isolamento Termok8 Modulari. Dotato di omologazione secondo EAD 00416-00-0404</p> <p>Necessaria per Termok8 Modulare e consigliata per Termok8 texture design</p> | <p>Sized, unravel-proof, glass fibre reinforcement mesh, resistant to alkalis, designed for the Termok8 modular insulation systems. Certified according to EAD 00416-00-0404</p> <p>Required for the Termok8: Modular system and recommended for the Termok8 texture design</p> | <p>Malla de armadura en fibra y vidrio aprestada, antidesmallante, resistente a los álcalis para sistemas de aislamiento Termok8 Modulares. Homologado según EAD 00416-00-0404</p> <p>Necesaria para Termok8 Modular y aconsejada para Termok8 texture design</p> |
| <p>Colore: grigia con scala graduata per il montaggio.</p> <p>Resistenza all'urto: 20Joule con EPS MAX e 60 Joule con Klebocem R110J</p> <p>Misure: 1 x 50 m per totali 50 m²</p> <p>Peso: 225 g/m²</p> <p>Resa (con le necessarie sovrapposizioni): 1,10 m² di rete per 1 m² di supporto</p> | <p>Colours available: grey with linear graduation for installation.</p> <p>Impact resistance: 20 Joule with EPS MAX and 60 Joule with Klebocem R110J</p> <p>Size: 1 x 50 m for a total of 50 m²</p> <p>Weight: 225 g/m²</p> <p>Coverage (with required overlapping): 1.10 m² of mesh per 1 m² of substrate</p> | <p>Colores: gris con escala graduada para el montaje.</p> <p>Resistencia al impacto: 20 julios con EPS MÁX y 60 julios con Klebocem R110J</p> <p>Medidas: 1 x 50 m por un total de 50 m²</p> <p>Peso: 225 g/m²</p> <p>Rendimiento (con las necesarias superposiciones): 1,10 m² de malla por 1 m² de soporte</p> |

| tecniche | certificazioni | proprietà | tecnologie |
|----------|----------------|-----------|------------|
| | | | |

rete angolare per intradossi aperture



| angolare preformato per imbotti aperture con armatura diagonale | shaped corner mesh for diagonally reinforced window and door intradoses | angular preformato para intradoses de aberturas con armadura diagonal |
|---|--|--|
| <p>Angolare preformato tridimensionale utilizzato per il rinforzo diagonale e degli angoli interni di imbotti di porte e finestre per sistemi di isolamento a cappotto. Prepiegato e presaldato.</p> <p>Realizzato con rete di armatura in fibra di vetro di tipo E, impregnata con resine antialcaline SBR, interasse 3,5 x 3,8 mm</p> | <p>Three-dimensionally shaped corner mesh used for diagonal and internal corner reinforcement of window and door intradoses for external thermal insulation systems. Pre-folded and pre-welded.</p> <p>Made of type E glass fibre reinforcement mesh, impregnated with SBR anti-alkaline resin, spacing 3.5 x 3.8 mm</p> | <p>Angular preformato tridimensional utilizado para el refuerzo diagonal y de los ángulos interiores de intradoses de puertas y ventanas para sistemas de aislamiento por capas. Predoblado y presoldado. Realizada con malla de armadura en fibra de vidrio de tipo E, impregnada con resinas antialcalinas SBR, distancia entre centros 3,5 x 3,8 mm</p> |
| <p>Peso: 165 gr/m²</p> <p>Misure: 20 x 30 cm altezza 10 cm 20 x 30 cm altezza 20 cm</p> <p>Confezione: 25 pezzi</p> | <p>Weight: 165 gr/m²</p> <p>Size: 20 x 30 cm height 10 cm 20 x 30 cm height 20 cm</p> <p>Package: 25 pieces</p> | <p>Peso: 165 gr/m²</p> <p>Medidas: 20 x 30 cm altura 10 cm 20 x 30 cm altura 20 cm</p> <p>Envase: 25 piezas</p> |

rete a fazzoletto per armatura spigoli finestre



| rete di armatura per angoli aperture con armatura diagonale | reinforcement mesh for corner openings with diagonal reinforcement | malla de armadura para ángulos de aberturas con armadura diagonal |
|---|---|--|
| <p>Angolare preformato utilizzato per l'esecuzione dell'armatura diagonale in corrispondenza degli angoli di aperture come finestre e porte. Utilizzata come rinforzo per disperdere le tensioni e prevenire così fenomeni fessurativi, garantendo la continuità dell'armatura del sistema cappotto.</p> <p>Realizzato con rete di armatura in fibra di vetro di tipo E, impregnata con resine antialcaline SBR, interasse 3,5 x 3,8 mm</p> | <p>Shaped corner used for diagonal reinforcement of the corners of such openings as windows and doors. Used as a reinforcement to dissipate tensions and prevent cracking, thus guaranteeing continuity in the reinforcement of external thermal insulation systems.</p> <p>Made of type E glass fibre reinforcement mesh, impregnated with SBR anti-alkaline resin, spacing 3.5 x 3.8 mm</p> | <p>Angular preformato utilizzato para la ejecución de la armadura diagonal coincidiendo con los ángulos de aberturas como ventanas y puertas. Utilizada como refuerzo para dispersar las tensiones y prevenir así fenómenos de fisuras, garantizando la continuidad de la armadura del sistema por capas. Realizada con malla de armadura en fibra de vidrio de tipo E, impregnada con resinas antialcalinas SBR, distancia entre centros 3,5 x 3,8 mm</p> |
| <p>Peso: 165 gr/m²</p> <p>Misure: 33,5 x 50 cm</p> <p>Confezione: 50 pz</p> | <p>Weight: 165 gr/m²</p> <p>Size: 33.5 x 50 cm</p> <p>Package: 50 pcs</p> | <p>Peso: 165 gr/m²</p> <p>Medidas: 33,5 x 50 cm</p> <p>Envase: 50 piezas</p> |

rivatone plus g15

scheda
tecnicadata
sheetficha
técnica

| rivestimento acrilico a spessore 1,5 mm | esterno | acrylic coating - 1.5 mm thick | outdoor | revestimiento acrílico de espesor 1,5 mm | exterior |
|--|---------|--|---------|--|----------|
| Rivestimento a base di resine vinil-acriliche in dispersione, additivi atti a facilitare l'applicazione e la filmazione, graniglie di marmo e sabbie quarzifere ad assorbimento controllato grana max 1,5mm. Forma un film resistente all'attacco di alghe, funghi e muffe certificato dal Fraunhofer-Institut für Bauphysik di Monaco. Prodotto verificato secondo le norme UNI EN 15824 e ETAG n. 004 per l'uso del marchio CE. Per uso professionale. | | Coating based on acrylic resins in dispersion. Contains additives that facilitate application and formation of a film as well as marble granules and quartz sand with controlled absorption, max particle size 1.5 mm. Forms a film resistant to algae, fungi, mould and mildew certified by the Fraunhofer-Institut für Bauphysik of Munich. Product tested according to UNI EN 15824 and ETAG no. 004 for use of CE marking. For professional use. | | Revestimiento a base de resinas vinilicas-acrilicas en dispersión, aditivos con la función de facilitar la aplicación y la formación de película, granallas de mármol y arenas cuarcíferas de absorción controlada de grano máx 1,5 mm. Forma una película resistente al ataque de algas, hongos y mohos. Certificado por el Fraunhofer-Institut für Bauphysik de Munich. Producto verificado según las normas UNI EN 15824 y ETAG n.º 004 para el uso de la marca CE. Para uso profesional. | |
| Granulometria: 1,5 mm Attrezzatura: frattazzo metallico, frattazzo di plastica Diluizione: pronto uso Resa (1 mano): 3 kg/m ² - Per confezione (25 kg): 8,3 m ² | | Particle Size: 1,5 mm Equipment: metal trowel, plastic trowel Dilution: ready to use Coverage (1 coat): 3 kg/m ² - Per pack (25 kg): 8,3 m ² | | Granulometría: 1,5 mm Herramientas: llana metálica, llana de plástico Dilución: listo para usar Rendimiento (1 capa): 3 kg/m ² - Por envase (25 kg): 8,3 m ² | |

| tecniche | certificazioni | proprietà | tecnologie |
|----------|----------------|-----------|------------|
| | | | |

rivatone plus g12

scheda
tecnicadata
sheetficha
técnica

| rivestimento acrilico a spessore 1,2 mm | esterno | acrylic coating - 1.2 mm thick | outdoor | revestimiento acrílico de espesor 1,2 mm | exterior |
|--|---------|---|---------|---|----------|
| Rivestimento a base di resine vinil-acriliche in dispersione, additivi atti a facilitare l'applicazione e la filmazione, graniglie di marmo e sabbie quarzifere ad assorbimento controllato grana max 1,2mm. Forma un film resistente all'attacco di alghe, funghi e muffe certificato dal Fraunhofer-Institut für Bauphysik di Monaco. Prodotto verificato secondo le norme UNI EN 15824 e ETAG n. 004 per l'uso del marchio CE. Per uso professionale. | | Coating based on acrylic resins in dispersion. Contains additives that facilitate application and formation of a film as well as marble granules and quartz sand with controlled absorption, max particle size 1.2mm. Forms a film resistant to algae, fungi, mould and mildew certified by the Fraunhofer-Institut für Bauphysik of Munich. Product tested according to UNI EN 15824 and ETAG no. 004 for use of CE marking. For professional use. | | Revestimiento a base de resinas vinilicas-acrilicas en dispersión, aditivos con la función de facilitar la aplicación y la formación de película, granallas de mármol y arenas cuarcíferas de absorción controlada de grano máx 1,2mm. Forma una película resistente al ataque de algas, hongos y mohos. Certificado por el Fraunhofer-Institut für Bauphysik de Munich. Producto verificado según las normas UNI EN 15824 y ETAG n.º 004 para el uso de la marca CE. Para uso profesional. | |
| Granulometria: 1,2 mm Attrezzatura: frattazzo metallico, frattazzo di plastica Diluizione: pronto uso Resa (1 mano): 2,2 kg/m ² - Per confezione (25 kg): 11,5 m ² | | Particle Size: 1,2 mm Equipment: metal trowel, plastic trowel Dilution: ready to use Coverage (1 coat): 2,2 kg/m ² - Per pack (25 kg): 11,5 m ² | | Granulometría: 1,2 mm Herramientas: llana metálica, llana de plástico Dilución: listo para usar Rendimiento (1 capa): 2,2 kg/m ² - Por envase (25 kg): 11,5 m ² | |

| tecniche | certificazioni | proprietà | tecnologie |
|----------|----------------|-----------|------------|
| | | | |

rivatone idrosiliconico plus g15



scheda
tecnica



data
sheet



ficha
técnica



| | | | | | |
|--|----------------|---|----------------|---|-----------------|
| rivestimento metilsiliconico a spessore 1,5 mm | esterno | methylsilicone coating - 1.5 mm thick | outdoor | revestimiento metilsilicónico de 1,5 mm de espesor | exterior |
| Rivestimento fibrato ad effetto minerale compatto a base di resine metil silossaniche, graniglie di quarzo e marmo grana max 1,5mm, additivi atti a facilitare l'applicazione e la filmazione, ad assorbimento controllato. Ottima idrorepellenza e traspirabilità. Forma un film resistente all'attacco di alghe, funghi e muffe, certificato dal Fraunhofer-Institut für Bauphysik di Monaco. Per uso professionale. | | Fibre-reinforced coating with compact mineral-effect based on methylsiloxane resins, quartz and marble granules (max. particle size 1.5 mm) plus additives to facilitate application and formation of a film, with controlled absorption. Superb breathability and water-repellent properties. Forms a film resistant to algae, fungi, mould and mildew certified by the Fraunhofer-Institut für Bauphysik of Munich. For professional use. | | Revestimiento fibrado de efecto mineral compacto a base de resinas metilsiloxánicas, granallas de cuarzo y mármol, grano máx. 1,5 mm, aditivos para facilitar la aplicación y la formación de película, de absorción controlada. Excelente hidrorrepelencia y transpirabilidad. Forma una película resistente al ataque de algas, hongos y mohos, certificado por el Fraunhofer-Institut für Bauphysik de Munich. Para uso profesional. | |
| Granulometria: 1,5 mm Attrezzatura: frattazzo metallico, frattazzo di plastica Diluizione: pronto uso Resa (1 mano): 3 kg/m ² - Per confezione (25 kg): 8,3 m ² | | Particle Size: 1,5 mm Equipment: metal trowel, plastic trowel Dilution: ready to use Coverage (1 coat): 3 kg/m ² - Per pack (25 kg): 8.3 m ² | | Granulometría: 1,5 mm Herramientas: llana metálica, llana de plástico Dilución: listo para usar Rendimiento (1 capa): 3 kg/m ² - Por envase (25 kg): 8,3 m ² | |

| | | | |
|-----------------|-----------------------|------------------|-------------------|
| tecniche | certificazioni | proprietà | tecnologie |
| | | | |

rivatone idrosiliconico plus g12



scheda
tecnica



data
sheet



ficha
técnica









| | | | | | |
|--|----------------|---|----------------|--|-----------------|
| rivestimento metilsiliconico a spessore 1,2 mm | esterno | methylsilicone coating - 1.2 mm thick | outdoor | revestimiento metilsilicónico de 1,2 mm de espesor | exterior |
| Rivestimento fibrato ad effetto minerale compatto a base di resine metil silossaniche, graniglie di quarzo e marmo grana max 1,2mm, additivi atti a facilitare l'applicazione e la filmazione, ad assorbimento controllato. Ottima idrorepellenza e traspirabilità. Forma un film resistente all'attacco di alghe, funghi e muffe, certificato dal Fraunhofer-Institut für Bauphysik di Monaco. Per uso professionale. | | Fibre-reinforced coating with compact mineral-effect based on methylsiloxane resins, quartz and marble granules (max. Particle Size: 1.2mm) plus additives to facilitate application and formation of a film, with controlled absorption. Superb breathability and water-repellent properties. Forms a film resistant to algae, fungi, mould and mildew certified by the Fraunhofer-Institut für Bauphysik of Munich. For professional use. | | Revestimiento fibrado de efecto mineral compacto a base de resinas metilsiloxánicas, granallas de cuarzo y mármol, grano máx. 1,2mm, aditivos para facilitar la aplicación y la formación de película, de absorción controlada. Excelente hidrorrepelencia y transpirabilidad. Forma una película resistente al ataque de algas, hongos y mohos, certificado por el Fraunhofer-Institut für Bauphysik de Munich. Para uso profesional. | |
| Granulometria: 1,2 mm Attrezzatura: frattazzo metallico, frattazzo di plastica Diluizione: pronto uso Resa (1 mano): 2,2 kg/m ² - Per confezione (25 kg): 11,4 m ² | | Particle Size: 1,2 mm Equipment: metal trowel, plastic trowel Dilution: ready to use Coverage (1 coat): 2.2 kg/m ² - Per pack (25 kg): 11.4 m ² | | Granulometría: 1,2 mm Herramientas: llana metálica, llana de plástico Dilución: listo para usar Rendimiento (1 capa): 2,2 kg/m ² - Por envase (25 kg): 11,4 m ² | |

| | | | |
|-----------------|-----------------------|------------------|-------------------|
| tecniche | certificazioni | proprietà | tecnologie |
| | | | |

rivatone plus trv g15

scheda
tecnicadata
sheetficha
técnica

| rivestimento acrilossilossanico a spessore 1,5 mm | esterno | acrylic-siloxane coating - 1.5 mm thick | outdoor | revestimiento acrilsiloxánico de espesor 1,5 mm | exterior |
|---|---------|--|---------|---|----------|
| Rivestimento fibrato ad effetto compatto a base di resine acriliche e silossani idrofobizzati grana max 1,5mm indicato come finitura per i principali sistemi Termok8. A film protetto dall'attacco di alghe, muffe e microorganismi. certificato dal Fraunhofer-Institut für Bauphysik di Monaco. Prodotto verificato secondo le norme UNI EN 15824 e ETAG n. 004 per l'uso del marchio CE. Per uso professionale. | | Fibre-reinforced coating with compact effect based on acrylic resins and water-repellent siloxanes with a maximum particle size of 1.5 mm, suitable as top coat for the main Termok8 systems. Forms a film resistant to algae, mould and microorganisms certified by the Fraunhofer-Institut für Bauphysik of Munich. Product tested according to UNI EN 15824 and ETAG no. 004 for use of CE marking. For professional use. | | Revestimiento fibrado de efecto compacto a base de resinas acrílicas y siloxanos hidrofobizados, grano máx. 1,5 mm indicado como acabado para los principales sistemas Termok8. Película protegida contra el ataque de algas, mohos y microorganismos. Certificado por el Fraunhofer-Institut für Bauphysik de Munich. Producto verificado según las normas UNI EN 15824 y ETAG n.º 004 para el uso de la marca CE. Para uso profesional. | |
| Granulometria: 1,5 mm Attrezzatura: frattazzo metallico, frattazzo di plastica Diluizione: pronto uso Resa (1 mano): 3 kg/m ² - Per confezione (25 kg): 8,3 m ² | | Particle Size: 1,5 mm Equipment: metal trowel, plastic trowel Dilution: ready to use Coverage (1 coat): 3 kg/m ² - Per pack (25 kg): 8,3 m ² | | Granulometría: 1,5 mm Herramientas: llana metálica, llana de plástico Dilución: listo para usar Rendimiento (1 capa): 3 kg/m ² - Por envase (25 kg): 8,3 m ² | |

| tecniche | certificazioni | proprietà | tecnologie |
|--|---|--|---|
|  COLOURABLE  WATER BASED  TROWEL  READY TO USE |  BBA  ETA  CE  EN 15824  EPD  BREATHABLE |  V2  BREATHABLE |  plus  siloxan 4 |

rivatone plus trv g12

scheda
tecnicadata
sheetficha
técnica

| rivestimento acrilossilossanico a spessore 1,2 mm | esterno | acrylic-siloxane coating - 1.2 mm thick | outdoor | revestimiento acrilsiloxánico de espesor 1,2 mm | exterior |
|---|---------|---|---------|--|----------|
| Rivestimento fibrato ad effetto compatto a base di resine acriliche e silossani idrofobizzati grana max 1,2mm indicato come finitura per i principali sistemi Termok8. A film protetto dall'attacco di alghe, muffe e microorganismi. certificato dal Fraunhofer-Institut für Bauphysik di Monaco. Prodotto verificato secondo le norme UNI EN 15824 e ETAG n. 004 per l'uso del marchio CE. Per uso professionale. | | Fibre-reinforced coating with compact effect based on acrylic resins and water-repellent siloxanes with a maximum particle size of 1.2mm, suitable as top coat for the main Termok8 systems. Forms a film resistant to algae, mould and microorganisms certified by the Fraunhofer-Institut für Bauphysik of Munich. Product tested according to UNI EN 15824 and ETAG no. 004 for use of CE marking. For professional use. | | Revestimiento fibrado de efecto compacto a base de resinas acrílicas y siloxanos hidrofobizados, grano máx. 1,2mm indicado como acabado para los principales sistemas Termok8. Película protegida contra el ataque de algas, mohos y microorganismos. Certificado por el Fraunhofer-Institut für Bauphysik de Munich. Producto verificado según las normas UNI EN 15824 y ETAG n.º 004 para el uso de la marca CE. Para uso profesional. | |
| Granulometria: 1,2 mm Attrezzatura: frattazzo metallico, frattazzo di plastica Diluizione: pronto uso Resa (1 mano): 2,2 kg/m ² - Per confezione (25 kg): 12 m ² | | Particle Size: 1,2 mm Equipment: metal trowel, plastic trowel Dilution: ready to use Coverage (1 coat): 2,2 kg/m ² - Per pack (25 kg): 12 m ² | | Granulometría: 1,2 mm Herramientas: llana metálica, llana de plástico Dilución: listo para usar Rendimiento (1 capa): 2,2 kg/m ² - Por envase (25 kg): 12 m ² | |

| tecniche | certificazioni | proprietà | tecnologie |
|--|---|--|---|
|  COLOURABLE  WATER BASED  TROWEL  READY TO USE |  BBA  ETA  CE  EN 15824  EPD  BREATHABLE |  V2  BREATHABLE |  plus  siloxan 4 |

rivatone plus trv g10



scheda
tecnica



data
sheet



ficha
técnica



| rivestimento acrilossilossanico a spessore 1,0 mm | esterno | acrylic-siloxane coating - 1.0 mm thick | outdoor | revestimiento acrilossiloxánico de espesor 1,0 mm | exterior |
|---|----------------|---|----------------|--|-----------------|
| Rivestimento fibrato ad effetto compatto a base di resine acriliche e silossani idrofobizzati grana max 1mm indicato come finitura per i principali sistemi Termok8. A film protetto dall'attacco di alghe, muffe e microorganismi. certificato dal Fraunhofer-Institut für Bauphysik di Monaco. Prodotto verificato secondo le norme UNI EN 15824 e ETAG n. 004 per l'uso del marchio CE. Per uso professionale. | | Fibre-reinforced coating with compact effect based on acrylic resins and water-repellent siloxanes with a maximum particle size of 1mm, suitable as top coat for the main Termok8 systems. Forms a film resistant to algae, mould and microorganisms certified by the Fraunhofer-Institut für Bauphysik of Munich. Product tested according to UNI EN 15824 and ETAG no. 004 for use of CE marking. For professional use. | | Revestimiento fibrado de efecto compacto a base de resinas acrílicas y siloxanos hidrofobizados, grano máx. 1mm indicado como acabado para los principales sistemas Termok8. Película protegida contra el ataque de algas, mohos y microorganismos. Certificado por el Fraunhofer-Institut für Bauphysik de Munich. Producto verificado según las normas UNI EN 15824 y ETAG n.º 004 para el uso de la marca CE. Para uso profesional. | |
| Granulometria: 1,0 mm Attrezzatura: frattazzo metallico, frattazzo di plastica Diluizione: pronto uso Resa (1 mano): 1,8 kg/m ² - Per confezione (25 kg): 13,9 m ² | | Particle Size: 1,0 mm Equipment: metal trowel, plastic trowel Dilution: ready to use Coverage (1 coat): 1,8 kg/m ² - Per pack (25 kg): 13,9 m ² | | Granulometría: 1,0 mm Herramientas: llana metálica, llana de plástico Dilución: listo para usar Rendimiento (1 capa): 1,8 kg/m ² - Por envase (25 kg): 13,9 m ² | |

| tecniche | | | | certificazioni | | | | proprietà | | | | tecnologie | |
|----------|--|--|--|----------------|--|--|--|-----------|--|--|--|------------|--|
| | | | | | | | | | | | | | |

rivatone plus reflect g15

scheda
tecnicadata
sheetficha
técnica

| rivestimento a spessore riflettente a grana 1,5mm | esterno | thick reflective coating - particle size 1.5 mm | outdoor | revestimiento de espesor reflectante de grano 1,5 mm | exterior |
|--|---------|---|---------|--|----------|
| La sua formulazione a base di resine acriliche e graniglie max 1,5mm prevede l'uso di pigmenti "freddi" idonei a riflettere la luce nello spettro IR. Permette di realizzare finiture scure, anche nere, su cappotto termico limitando il riscaldamento eccessivo della superficie. Prodotto verificato secondo le norme UNI EN 15824 per l'uso del marchio CE. Per uso professionale. | | Its formulation based on acrylic resins and granules of max 1.5 mm involves the use of "cold" pigments able to reflect the light in the IR spectrum. Makes it possible to create dark, even black, topcoats on thermal insulation systems, limiting excessive heating of the surface. Product tested according to UNI EN 15824 for use of CE marking. For professional use. | | Su formulación a base de resinas acrílicas y granallas máx. 1,5 mm incluye pigmentos "fríos" idóneos para reflejar la luz de espectro IR. Permite realizar acabados oscuros, incluso negros, sobre sistema por capas térmico limitando el calentamiento excesivo de la superficie. Producto verificado según las normas UNI EN 15824 para el uso de la marca CE. Para uso profesional. | |
| Granulometria: 1,5 mm Attrezzatura: frattazzo metallico, frattazzo di plastica Diluizione: pronto uso Resa (1 mano): 3 kg/m ² - Per confezione (25 kg): 8,3 m ² | | Particle Size: 1,5 mm Equipment: metal trowel, plastic trowel Dilution: ready to use Coverage (1 coat): 3 kg/m ² - Per pack (25 kg): 8.3 m ² | | Granulometría: 1,5 mm Herramientas: llana metálica, llana de plástico Dilución: listo para usar Rendimiento (1 capa): 3 kg/m ² - Por envase (25 kg): 8,3 m ² | |

| tecniche | certificazioni | proprietà | tecnologie |
|--|--|-----------|---|
|  WATER BASED  TROWEL  READY TO USE |  BBA  CE  ETA  BREATHABLE | |  reflect  plus |

rivatone plus reflect g12

scheda
tecnicadata
sheetficha
técnica

| rivestimento a spessore riflettente a grana 1,2mm | esterno | thick reflective coating - particle size 1.2mm | outdoor | revestimiento de espesor reflectante de grano 1,2mm | exterior |
|--|---------|--|---------|---|----------|
| La sua formulazione a base di resine acriliche e graniglie max 1,2mm prevede l'uso di pigmenti "freddi" idonei a riflettere la luce nello spettro IR. Permette di realizzare finiture scure, anche nere, su cappotto termico limitando il riscaldamento eccessivo della superficie. Prodotto verificato secondo le norme UNI EN 15824 per l'uso del marchio CE. Per uso professionale. | | Its formulation based on acrylic resins and granules of max 1.2mm involves the use of "cold" pigments able to reflect the light in the IR spectrum. Makes it possible to create dark, even black, topcoats on thermal insulation systems, limiting excessive heating of the surface. Product tested according to UNI EN 15824 for use of CE marking. For professional use. | | Su formulación a base de resinas acrílicas y granallas máx. 1,2mm incluye pigmentos "fríos" idóneos para reflejar la luz de espectro IR. Permite realizar acabados oscuros, incluso negros, sobre sistema por capas térmico limitando el calentamiento excesivo de la superficie. Producto verificado según las normas UNI EN 15824 para el uso de la marca CE. Para uso profesional. | |
| Granulometria: 1,2 mm Attrezzatura: frattazzo metallico, frattazzo di plastica Diluizione: pronto uso Resa (1 mano): 2,2 kg/m ² - Per confezione (25 kg): 11,4 m ² | | Particle Size: 1,2 mm Equipment: metal trowel, plastic trowel Dilution: ready to use Coverage (1 coat): 2.2 kg/m ² - Per pack (25 kg): 11.4 m ² | | Granulometría: 1,2 mm Herramientas: llana metálica, llana de plástico Dilución: listo para usar Rendimiento (1 capa): 2,2 kg/m ² - Por envase (25 kg): 11,4 m ² | |

| tecniche | certificazioni | proprietà | tecnologie |
|--|--|-----------|---|
|  WATER BASED  TROWEL  READY TO USE |  BBA  CE  ETA  BREATHABLE | |  reflect  plus |

rivatone plus strong g15



scheda
tecnica



data
sheet



ficha
técnica



| | | |
|---|---|---|
| rivestimento per tinte intense a grana 1,5mm esterno | coating for intense colours - particle size 1.5mm outdoor | revestimiento para tintes intensos de grano 1,5 mm exterior |
| A base di resine acriliche in dispersione, additivi atti a facilitare l'applicazione e la fil-mazione, battericidi e fungicidi a vasto spet-tro d'azione, graniglie di marmo e sabbie quarzifere ad assorbimento controllato max 1,5mm. Permette di ottenere una vasta gam-ma di colori intensi e dal tono estremamente vivo minimizzando i rischi di decolorazione nel tempo. Prodotto verificato secondo le norme UNI EN 15824 per l'uso del marchio CE. Per uso professionale. | Based on acrylic resins in dispersion, contains additives to facilitate application and formation of a film. Contains broad spectrum bactericides, fungicides, marble granules and quartz sand with controlled absorption, max particle size 1.5 mm. Makes it possible to obtain a wide range of in-tense colours with vibrant tone, minimising the risk of discolouration over time. Product tested according to UNI EN 15824 for use of CE marking. For professional use. | A base de resinas acrílicas en dispersión, aditivos con la función de facilitar la aplica-ción y la formación de película, bactericidas y fungicidas de amplio espectro de acción, granallas de mármol y arenas cuarcíferas de absorción controlada máx 1,5 mm. Per-mite obtener una amplia gama de colores intensos y de tono extremadamente vivo, minimizando los riesgos de decoloración en el tiempo. Producto verificado según las normas UNI EN 15824 para el uso de la marca CE. Para uso profesional. |
| Granulometria: 1,5 mm Attrezzatura: frattazzo metallico, frattazzo di plastica Diluizione: pronto uso Resa (1 mano): 3 kg/m ² - Per confezione (25 kg): 8,3 m ² | Particle Size: 1,5 mm Equipment: metal trowel, plastic trowel Dilution: ready to use Coverage (1 coat): 3 kg/m ² - Per pack (25 kg): 8,3 m ² | Granulometría: 1,5 mm Herramientas: llana metálica, llana de plástico Dilución: listo para usar Rendimiento (1 capa): 3 kg/m ² - Por envase (25 kg): 8,3 m ² |

| | | | |
|---------------------|---------------------------|------------------|-----------------------|
| tecniche | certificazioni | proprietà | tecnologie |
|---------------------|---------------------------|------------------|-----------------------|

rivatone plus strong g12



scheda
tecnica



data
sheet



ficha
técnica



| | | |
|---|--|--|
| rivestimento per tinte intense a grana 1,2mm esterno | coating for intense colours - particle size 1.2mm outdoor | revestimiento para tintes intensos de grano 1,2mm exterior |
| A base di resine acriliche in dispersione, additivi atti a facilitare l'applicazione e la fil-mazione, battericidi e fungicidi a vasto spet-tro d'azione, graniglie di marmo e sabbie quarzifere ad assorbimento controllato max 1,2mm. Permette di ottenere una vasta gam-ma di colori intensi e dal tono estremamente vivo minimizzando i rischi di decolorazione nel tempo. Prodotto verificato secondo le norme UNI EN 15824 per l'uso del marchio CE. Per uso professionale. | Based on acrylic resins in dispersion, contains additives to facilitate application and formation of a film. Contains broad spectrum bactericides, fungicides, marble granules and quartz sand with controlled absorption, max particle size 1.2mm. Makes it possible to obtain a wide range of in-tense colours with vibrant tone, minimising the risk of discolouration over time. Product tested according to UNI EN 15824 for use of CE marking. For professional use. | A base de resinas acrílicas en dispersión, aditivos con la función de facilitar la aplica-ción y la formación de película, bactericidas y fungicidas de amplio espectro de acción, granallas de mármol y arenas cuarcíferas de absorción controlada máx 1,2mm. Per-mite obtener una amplia gama de colores intensos y de tono extremadamente vivo, minimizando los riesgos de decoloración en el tiempo. Producto verificado según las normas UNI EN 15824 para el uso de la marca CE. Para uso profesional. |
| Granulometria: 1,2 mm Attrezzatura: frattazzo metallico, frattazzo di plastica Diluizione: pronto uso Resa (1 mano): 2,2 kg/m ² - Per confezione (25 kg): 11,4 m ² | Particle Size: 1,2 mm Equipment: metal trowel, plastic trowel Dilution: ready to use Coverage (1 coat): 2,2 kg/m ² - Per pack (25 kg): 11,4 m ² | Granulometría: 1,2 mm Herramientas: llana metálica, llana de plástico Dilución: listo para usar Rendimiento (1 capa): 2,2 kg/m ² - Por en-vase (25 kg): 11,4 m ² |

| | | | |
|---------------------|---------------------------|------------------|-----------------------|
| tecniche | certificazioni | proprietà | tecnologie |
|---------------------|---------------------------|------------------|-----------------------|

rivatone clean plus g15

scheda
tecnicadata
sheetficha
técnica

| rivestimento acril silossanico autopulente 1,5 mm | esterno | self-cleaning acrylic- siloxane coating - 1.5 mm | outdoor | revestimiento acril siloxánico autolimpiador 1,5 mm | exterior |
|--|---------|--|---------|--|----------|
| Rivestimento granulometria max 1,5mm estremamente bianco che unisce alla caratteristica di traspirabilità, conferita dalla componente silossanica, un effetto foto-catalitico ossidante in grado di decomporre le sostanze organiche che vengono a contatto con la superficie, il supporto rimarrà, di conseguenza, bianco come appena realizzato. Resistente all'attacco di alghe, funghi e muffe certificato dal Fraunhofer-Institut für Bauphysik di Monaco. Per uso professionale. | | Extremely white coating (max. particle size: 1.5 mm) that combines the breathability characteristic of the siloxane component with an oxidative photocatalytic effect capable of decomposing the organic substances that come into contact with the surface, thus ensuring that the substrate will remain as white as when first applied. Resistance to algae, fungi, mould and mildew certified by the Fraunhofer-Institut für Bauphysik of Munich. For professional use. | | Revestimiento con granulometría máx.1,5 mm extremadamente blanco que une a la característica de traspirabilidad, proporcionada por el componente siloxánico, un efecto foto-catalítico oxidante capaz de descomponer las sustancias orgánicas que entran en contacto con la superficie; el soporte quedará, por consiguiente, blanco como recién hecho. Resistente al ataque de algas, hongos y mohos. Certificado por el Fraunhofer-Institut für Bauphysik de Munich. Para uso profesional. | |
| Granulometria: 1,5 mm Attrezzatura: frattazzo metallico, frattazzo di plastica Diluizione: pronto uso Resa (1 mano): 3 kg/m ² - Per confezione (25 kg): 8,3 m ² | | Particle Size: 1,5 mm Equipment: metal trowel, plastic trowel Dilution: ready to use Coverage (1 coat): 3 kg/m ² - Per pack (25 kg): 8.3 m ² | | Granulometría: 1,5 mm Herramientas: llana metálica, llana de plástico Dilución: listo para usar Rendimiento (1 capa): 3 kg/m ² - Por envase (25 kg): 8,3 m ² | |

tecniche



certificazioni



proprietà

tecnologie



rivatone clean plus g12

scheda
tecnicadata
sheetficha
técnica

| rivestimento acril silossanico autopulente 1,2 mm | esterno | self-cleaning acrylic- siloxane coating - 1.2 mm | outdoor | revestimiento acril siloxánico autolimpiador 1,2 mm | exterior |
|--|---------|---|---------|---|----------|
| Rivestimento granulometria max 1,2mm estremamente bianco che unisce alla caratteristica di traspirabilità, conferita dalla componente silossanica, un effetto foto-catalitico ossidante in grado di decomporre le sostanze organiche che vengono a contatto con la superficie, il supporto rimarrà, di conseguenza, bianco come appena realizzato. Resistente all'attacco di alghe, funghi e muffe certificato dal Fraunhofer-Institut für Bauphysik di Monaco. Per uso professionale. | | Extremely white coating (max. particle size: 1.2mm) that combines the breathability characteristic of the siloxane component with an oxidative photocatalytic effect capable of decomposing the organic substances that come into contact with the surface, thus ensuring that the substrate will remain as white as when first applied. Resistance to algae, fungi, mould and mildew certified by the Fraunhofer-Institut für Bauphysik of Munich. For professional use. | | Revestimiento con granulometría máx 1,2 m extremadamente blanco que une a la característica de traspirabilidad, proporcionada por el componente siloxánico, un efecto foto-catalítico oxidante capaz de descomponer las sustancias orgánicas que entran en contacto con la superficie; el soporte quedará, por consiguiente, blanco como recién hecho. Resistente al ataque de algas, hongos y mohos. Certificado por el Fraunhofer-Institut für Bauphysik de Munich. Para uso profesional. | |
| Granulometria: 1,2 mm Attrezzatura: frattazzo metallico, frattazzo di plastica Diluizione: pronto uso Resa (1 mano): 2,2 kg/m ² - Per confezione (25 kg): 12,5 m ² | | Particle Size: 1,2 mm Equipment: metal trowel, plastic trowel Dilution: ready to use Coverage (1 coat): 2,2 kg/m ² - Per pack (25 kg): 12.5 m ² | | Granulometría: 1,2 mm Herramientas: llana metálica, llana de plástico Dilución: listo para usar Rendimiento (1 capa): 2,2 kg/m ² - Por envase (25 kg): 12,5 m ² | |

tecniche



certificazioni



proprietà

tecnologie



rivatone clean plus g10



scheda
tecnica



data
sheet



ficha
técnica



| | | | | | |
|---|----------------|---|----------------|---|-----------------|
| rivestimento acrilossilossanico autopulente 1,0 mm | esterno | self-cleaning acrylic- siloxane coating - 1.0 mm | outdoor | revestimiento acrilossiloxánico autolimpiador 1,0 mm | exterior |
| Rivestimento granulometria max 1mm estremamente bianco che unisce alla caratteristica di traspirabilità, conferita dalla componente silossanica, un effetto fotocatalitico ossidante in grado di decomporre le sostanze organiche che vengono a contatto con la superficie, il supporto rimarrà, di conseguenza, bianco come appena realizzato. Resistente all'attacco di alghe, funghi e muffe certificato dal Fraunhofer-Institut für Bauphysik di Monaco. Per uso professionale. | | Extremely white coating (max.particle size 1mm) that combines the breathability characteristic of the siloxane component with an oxidative photocatalytic effect capable of decomposing the organic substances that come into contact with the surface, thus ensuring that the substrate will remain as white as when first applied. Resistance to algae, fungi, mould and mildew certified by the Fraunhofer-Institut für Bauphysik of Munich. For professional use. | | Revestimiento con granulometría máx 1mm extremadamente blanco que une a la característica de traspirabilidad, proporcionada por el componente siloxánico, un efecto foto-catalítico oxidante capaz de descomponer las sustancias orgánicas que entran en contacto con la superficie; el soporte quedará, por consiguiente, blanco como recién hecho. Resistente al ataque de algas, hongos y mohos. Certificado por el Fraunhofer-Institut für Bauphysik de Munich. Para uso profesional. | |
| Granulometria: 1,0 mm Attrezzatura: frattazzo metallico, frattazzo di plastica Diluizione: pronto uso Resa (1 mano): 1,8 kg/m ² - Per confezione (25 kg): 13,9 m ² | | Particle Size: 1,0 mm Equipment: metal trowel, plastic trowel Dilution: ready to use Coverage (1 coat): 1,8 kg/m ² - Per pack (25 kg): 13.9 m ² | | Granulometría: 1,0 mm Herramientas: llana metálica, llana de plástico Dilución: listo para usar Rendimiento (1 capa): 1,8 kg/m ² - Por envase (25 kg): 13,9 m ² | |

| | | | |
|-----------------|-----------------------|------------------|-------------------|
| tecniche | certificazioni | proprietà | tecnologie |
| | | | |

fondo K plus



scheda
tecnica



data
sheet



ficha
técnica



| | | | | | |
|--|----------------|---|----------------|--|-----------------|
| fondo acrilossilossanico all'acqua pigmentato | esterno | water-based pigmented acrylic- siloxane base coat | outdoor | fondo acrilossiloxánico al agua pigmentado | exterior |
| Fondo intermedio coprente per rivestimento a cappotto specifico per successiva applicazione di rivestimenti colorati a spessore. La tecnologia PLUS garantisce la protezione del film dall'attacco di alghe, muffe e microorganismi. La Classe TVOC A+ lo rende idoneo per ottemperare ai protocolli CAM, -Leed Breeam. Per uso professionale. | | Opaque intermediate base coat for external thermal insulation system specifically designed for subsequent application of thick coloured coatings. The PLUS technology ensures that the film is resistant to algae, mould and microorganisms. Classified TVOC A+, it complies with CAM, Leed Breeam protocols. For professional use. | | Fondo intermedio cubriente para revestimiento por capas específico para la posterior aplicación de revestimientos de color en espesor. La tecnología PLUS garantiza la protección de la película contra el ataque de algas, mohos y microorganismos. La Clase TVOC A+ la hace idónea para cumplir con los protocolos CAM, Leed y Breeam. Para uso profesional. | |
| Attrezzatura: pennello, rullo a pelo corto, airless Diluizione: acqua - 10-20% Resa (1 mano): 4-4,5 m ² /l - Per confezione (14 l): 63 m ² | | Equipment: brush, short-haired roller, airless spraying equipment Dilution: water - 10-20% Coverage (1 coat): 4-4.5 m ² /l - Per pack (14 l): 63 m ² | | Herramientas: brocha, rodillo de pelo corto, pistola pulverizadora Dilución: agua - 10-20 % Rendimiento (1 capa): 4-4,5 m ² /l- Por envase (14 l): 63 m ² | |

| | | | |
|-----------------|-----------------------|------------------|-------------------|
| tecniche | certificazioni | proprietà | tecnologie |
| | | | |

listellotto buchtal

 scheda
tecnica

 data
sheet

 ficha
técnica

| listello in gres porcellanato estruso | strip in extruded porcelain stoneware | listón de gres porcelánico extrusionado |
|--|--|---|
| Linea Base Gold Line in grès | Gold Line basic line, stoneware | Línea Base Gold Line en gres |
| Per sistema Termok8: Modular D Dimensioni: 25 x 8,30 cm Confezione: 1 scatola = m ² 0,83 | For system Termok8: Modular D Size: 25 x 8.30 cm Package: 1 box = 0.83 m ² | Para sistema Termok8: Modular D Medidas: 25 x 8,30 cm Envase: 1 caja = 0,83 m ² |

listello facciavista



| listello facciate estruso in cotto | extruded brick facades strip | tira de fachadas de ladrillo extrusionado |
|---|--|--|
| Listello estruso in cotto tipo Style Terremilia o tipo Fornace Fosdondo. | Extruded terracotta slip, such as Style Terremilia or Fornace Fosdondo. | Listel extruido en barro cocido tipo Style Terremilia o tipo Fornace Fosdondo. |
| Per sistema: Termok8 Modular Facciavista Dimensioni: 24,5 x 5,5 x 1,6 cm Confezione: 1 m ² = 60 pezzi | For the system: Termok8 Modular Facciavista Size: 24.5 x 5.5 x 1.6 cm Package: 1 m ² = 60 pieces | Para sistema: Termok8 Modular Facciavista Medidas: 24,5 x 5,5 x 1,6 cm Envase: 1 m ² = 60 piezas |
| Versione angolare del Listello Facciavista. | Corner version of Facciavista slip. | Versión angular del listel Facciavista. |
| Dimensioni: 24,5 x 5,5 x 11,7 x 1,6 cm Confezione: 1 m = 15 pezzi | Size: 24.5 x 5.5 x 11.7 x 1.6 cm Package: 1 m = 15 pieces | Medidas: 24,5 x 5,5 x 11,7 x 1,6 cm Envase: 1 m = 15 piezas |

listello a mano san marco



| listello facciavista in cotto in pasta | exposed brick slat in pasta | tira expuesta en pasta cocida |
|---|--|--|
| Listello in cotto a mano San Marco. | San Marco handmade terracotta slip. | Listel en barro cocido a mano San Marco. |
| Per sistema: Termok8 Modular Facciavista Dimensioni: 25 x 5,5 x 2 cm Confezione: 1 m ² = 60 pezzi | For the system: Termok8 Modular Facciavista Size: 25 x 5.5 x 2 cm Package: 1 m ² = 60 pieces | Para sistema: Termok8 Modular Facciavista Medidas: 25 x 5,5 x 2 cm Envase: 1 m ² = 60 piezas |
| Versione angolare del Listello a mano San Marco. | Corner version of San Marco handmade slip. | Versión angular del Listel a mano San Marco. |
| Dimensioni: 25 x 5,5 h x 12 x 2 cm Confezione: 1 m = 15 pezzi | Size: 25 x 5.5 h x 12 x 2 cm Package: 1 m = 15 pieces | Medidas: 25 x 5,5 h x 12 x 2 cm Envase: 1 m = 15 piezas |

listello flex

 scheda
tecnica

 data
sheet

 ficha
técnica

| listello effetto facciavista a basso modulo elastico | exposed-effect strip with low modulus of elasticity | tira de efecto visto con bajo módulo de elasticidad |
|--|---|---|
| Per sistema: Termok8 Flex e Modular Flex L.R. | For the system: Termok8 Flex and Modular Flex L.R. | Para sistema: Termok8 Flex y Modular Flex L.R. |
| Dimensioni: 24x 5,2 cm Colori Classici: Rosso Sahara - Rosso Toscana - bianco (per m. con fuga da 12 mm) Confezione: da 2 m ² inclusa fuga da 12 mm. | Size: 24x 5.2 cm Classic Colours: Sahara Red - Tuscan Red - white (for 12 mm joint) Package: 2 m ² including 12 mm joint. | Medidas: 24x 5,2 cm Colores Clásicos: Rojo Sahara - Rojo Toscana - blanco (para m. con fuga de 12 mm) Envases: de 2 m ² incluida la junta de 12 mm. |
| Angolari | Corner version | Angulares |
| Colori Classici: Rosso Sahara - Rosso Toscana - bianco (per m. con fuga da 12 mm) Confezione: da 1,5 m. inclusa fuga da 12 mm. | Classic Colours: Sahara Red - Tuscan Red - white (for 12 mm joint) Package: 1,5 m including 12 mm joint. | Colores Clásicos: Rojo Sahara - Rojo Toscana - blanco (para m. con fuga de 12 mm) Envases: de 1,5 m. incluida fuga de 12 mm. |



Elementi decorativi sagomati in EPS (a norma UNI EN 13163) prerasati con malte fibrate. Specifici per applicazioni esterne; sovraverniciabili. Oltre alle proposte standard, possono essere realizzati profili personalizzati nella forma e nelle dimensioni in funzione delle esigenze tecniche ed estetiche del progetto, garantendo la massima flessibilità di un sistema Termok8 su misura.

Shaped, decorative elements in EPS (compliant with UNI EN 13163) preskimmed with fibrous mortar. Specific for external applications. They can be overpainted. Besides the standard products, profile size and shape can be customized to meet the technical and aesthetic requirements of the project, thus guaranteeing utmost flexibility for a custom Termok8 system.

Elementos decorativos perfilados en EPS (conforme a la norma UNI EN 13163) con enrasado previo con morteros fibrados. Específicos para aplicaciones externas; admiten recubrimiento de pintura. Además de las propuestas estándar, pueden realizarse perfiles personalizados en la forma y en las Dimensiones en función de las necesidades técnicas y estéticas del proyecto, garantizando la máxima flexibilidad de un sistema Termok8 a medida.

cornice sottogronda - under gutter cornice - cornisa bajo canaletta

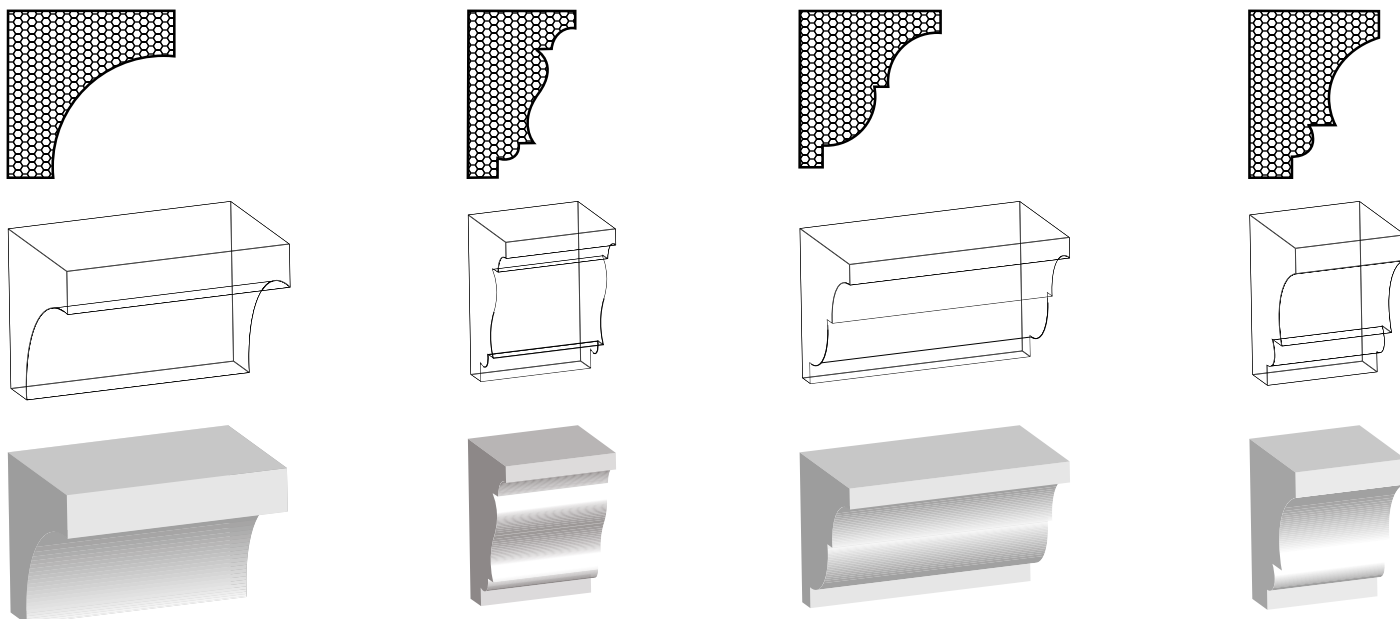

marcapiano - string course - imposta

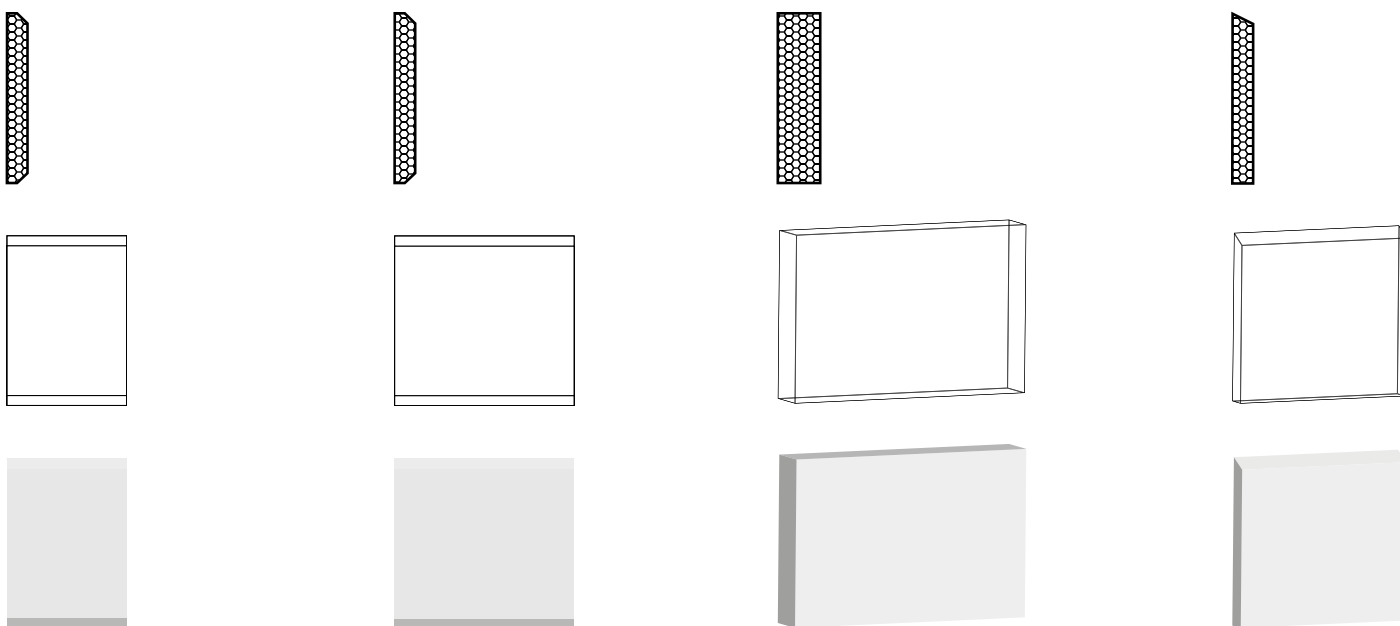

decoro lineare - linear decoration - decoración lineal

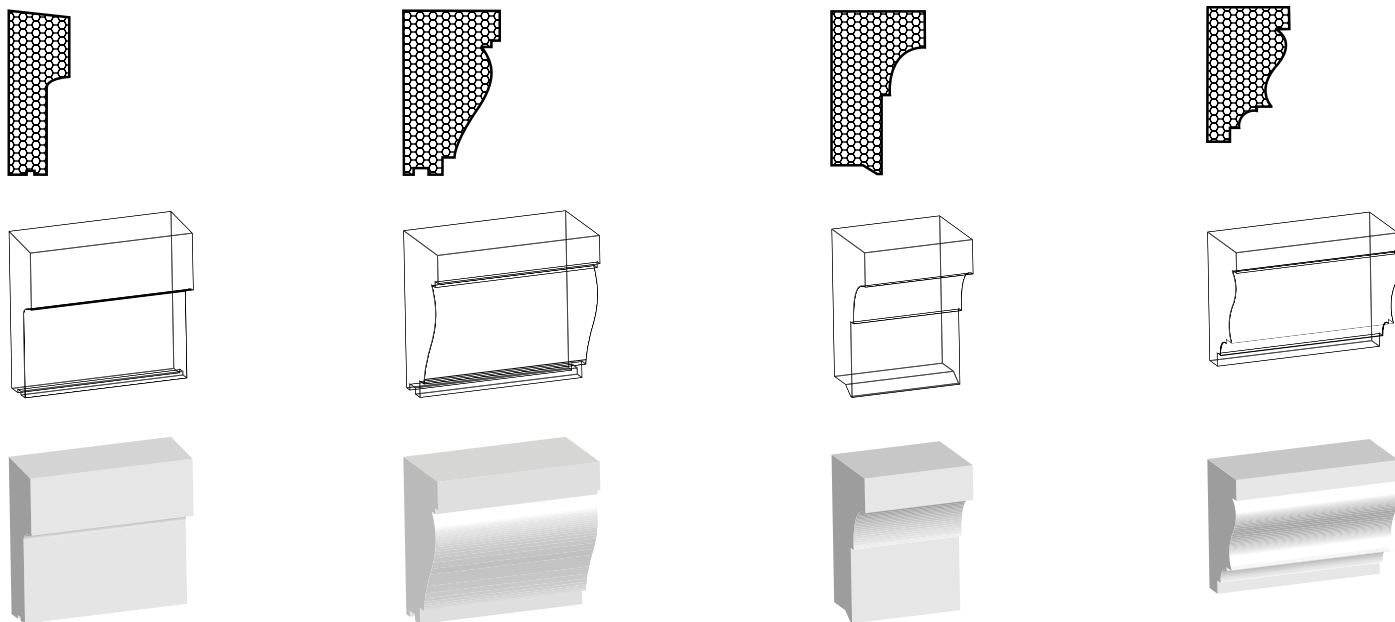
**bugna - rusticated ashlar - almohadilla**

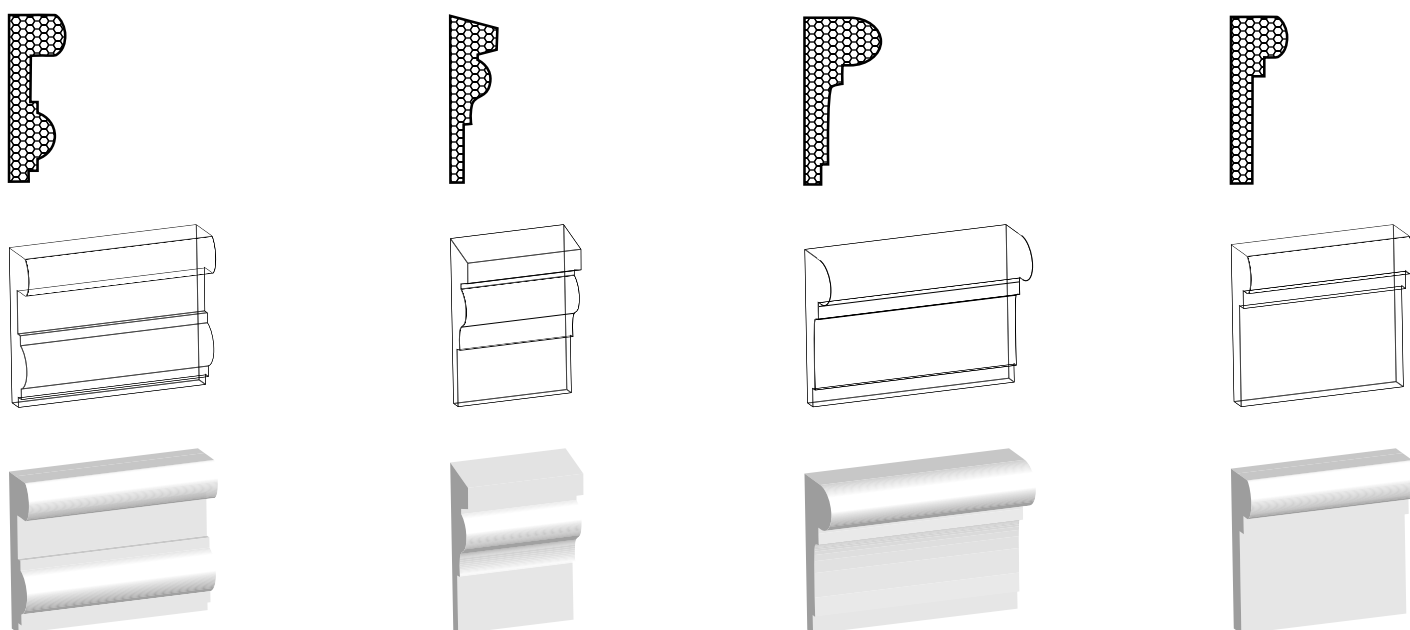

punta per trapano high speed



| | | |
|--|---|---|
| punta speciale per la foratura veloce e sicura di laterizi forati | special drill bit for fast, safe drilling of hollow brick | punta especial para perforación rápida y segura de ladrillos huecos |
| Punta per foratura veloce di laterizi forati. Permette una riduzione dei tempi di foratura e della forza impiegata. Migliora fino al 60% la resistenza alla trazione del tassello rispetto alla foratura con le normali punte. | Bit for fast drilling of hollow bricks. It reduces drilling time and force required. It improves anchor tensile strength by 60% over drilling with standard bits. | Punta para perforación rápida de ladrillos huecos. Permite una reducción de los tiempos de perforación y de la fuerza empleada. Mejora hasta el 60 % la resistencia a la tracción del taco con respecto a la perforación con las puntas normales. |
| Eventuale confezione: 10 pezzi | Package: 10 pieces | Envase (en su caso): 10 piezas |

fresa per risanamento STR



| | | |
|--|--|--|
| fresa per asportazione puntuale del rivestimento a spessore della rasatura armata | milling cutter for removal of thick reinforced skim coat | fresa para retirada puntual del revestimiento de espesor del enrasado armado |
| Fresa per il consolidamento di sistemi a cappotto esistenti. Pensata per asportare lo strato di finitura esterna e la rete di armatura permettendo di montare tasselli ad incasso o a percussione. | milling cutter for consolidation of existing external thermal insulation systems. Designed to remove the outer topcoat and reinforcement mesh, making it possible to install recessed or percussion anchors. | Fresa para consolidación de sistemas por capas existentes. Pensada para retirar la capa de acabado externo y la malla de armadura permitiendo montar tacos encajados o de percusión. |

fresa per risanamento PTZ



| | | |
|--|--|---|
| fresa per asportazione puntuale del rivestimento a spessore | milling cutter for removal of thick coating | fresa para retirada puntual del revestimiento de espesor |
| Fresa per il consolidamento di sistemi a cappotto esistenti. Pensata per asportare solo lo strato di finitura esterna ed andare a tassellare il sistema attraverso la rete di armatura, sia con tasselli a percussione che ad avvitamento. | milling cutter for consolidation of existing external thermal insulation systems. Designed to remove only the outer topcoat and then anchor the system through the reinforcement mesh with either percussion or screw anchors. | Fresa para consolidación de sistemas por capas existentes. Pensada para retirar solo la capa de acabado externo para aplicar los tacos al sistema a través de la malla de armadura, con tacos que pueden ser de percusión o de rosca. |
| Fornita in un unico pezzo con testina di taglio già montata. | Supplied in one piece with cutting head already fitted. | Se entrega en una única pieza con cabezal de corte ya montado. |

inserto per il montaggio CT 2G



| | | |
|--|--|--|
| bit specifico per il montaggio a filo esterno del tassello CT 2G | specific bit for flush surface mounting of the CT 2G anchor | punta bit specifica para el montaje al ras externo del taco CT 2G |
| Strumento specifico per applicazione sulla testa dell'avvitatore, dotato di vite Torx per l'applicazione dei tasselli CT 2G. | Tool designed for application on the screw head, fit with a Torx screw for the application of CT 2G anchors. | Herramienta específica para aplicación en la cabeza del atornillador, dotado de tornillo Torx para la aplicación de los tacos CT 2G. |
| Lunghezza disponibile: 90 mm e 200mm Eventuale confezione: 10 pezzi | Available lengths: 90 mm and 200mm Package: 10 pieces | Largo disponible: 90 mm y 200 mm Envase (en su caso): 10 piezas |

inserto per il montaggio CT L



| | | |
|---|---|---|
| bit specifico per il montaggio a filo esterno del tassello CT L | specific bit for flush surface mounting of the CT L anchor | punta bit specifica para el montaje al ras externo del taco CT L |
| Strumento specifico per applicazione sulla testa dell'avvitatore, dotato di vite Torx per l'applicazione dei tasselli CT L. | Tool designed for application on the screw head, fit with a Torx screw for the application of CT L anchors. | Herramienta específica para aplicación en la cabeza del destornillador, equipada con un tornillo Torx para la aplicación de los tacos CT L. |
| Lunghezza disponibile: 50 mm | Available lengths: 50 mm | Largo disponible: 50 mm |

inserto per il montaggio CT S1



| | | |
|--|--|--|
| bit specifico per il montaggio a filo esterno del tassello CT S1 | specific bit for flush surface mounting of the CT S1 anchor | punta bit específica para el montaje al ras externo del taco CT S1 |
| Strumento specifico per applicazione sulla testa dell'avvitatore, dotato di vite Torx per l'applicazione dei tasselli CT S1. | Tool designed for application on the screw head, fit with a Torx screw for the application of CT S1 anchors. | Herramienta específica para aplicación en la cabeza del atornillador, dotado de tornillo Torx para la aplicación de los tacos CT S1. |

talpa per tassello CT 2G - CT L



| | | |
|---|--|--|
| talpa per tasselli CT 2G e CT L | circular drill bit for CT 2 G and CT L anchors | rosetta di fijación para tacos CT 2 G y CT L |
| Utensile specifico per il montaggio incassato dei tasselli CT 2 G e CT L. | Tool for perfect flush surface mounting of the CT 2 G and CT L anchor | Herramienta para un perfecto montaje al ras de los tacos CT 2 G y CT L |
| Kit costituito da: utensile, testine di taglio, avvitatore angolare, bits per l'avvitamento. | Kit consisting of: tool, cutting heads, angle screwdriver, bits for screwing. | Kit compuesto por: herramienta, cabezales de corte, destornillador angular, puntas para atornillar. |

talpa per tassello CT S1



| | | |
|--|--|--|
| talpa per tasselli CT S1 | circular drill bit for CT S1 anchors | rosetta di fijación para tacos CT S1 |
| Utensile per un perfetto montaggio a filo del tassello CT S1 | Tool for perfect flush mounting of the CT S1 anchors | Herramienta para un perfecto montaje enrasado del taco CT S1 |

kit ricambi per talpa - CT 2G e CT L



| | | |
|--|--|---|
| per talpa per tasselli CT 2G e CT L | for circular drill bit for CT 2G and CT L anchors | para rosetta di fijación para tacos CT 2G y CT L |
| Include 3 testine di taglio e 3 bits per l'avvitamento nel montaggio ad incasso. | Includes 3 cutting heads and 3 bits for screwing into recessed mounting. | Incluye 3 cabezales de corte y 3 puntas bit para atornillado en el montaje empotrado. |

spatola sagomata



| | | |
|---|---|---|
| spatola speciale sagomata per rasatura di fughe | special shaped spatula for skimming joints | espátula especial perfilada para enrasados de juntas |
| Spatolina opportunamente sagomata con specifici kit di accessori per la rasatura di fughe decorative eseguite con rete presagomata di tipo I (trapezio stretta), tipo II (trapezio larga) tipo III (triangolo). | Specially shaped spatula with kit of specific accessories for skimming decorative joints made with type I (trapezoidal - narrow), type II (trapezoidal - wide) and type III (triangular) shaped reinforcement mesh. | Espátula convenientemente perfilada con kit de accesorios específicos para el enrasado de juntas decorativas realizadas con malla previamente perfilada de tipo I (trapezio estrecha), tipo II (trapezio ancha) tipo III (triángulo). |

tagliatrice per eps da ponteggio



| | | |
|--|--|--|
| tagliatrice a caldo per il taglio preciso di pannelli in eps | hot cutter for precise cutting of EPS panels | cizalla en caliente para el corte preciso de paneles en eps |
| Tagliatrice a caldo per il taglio professionale di pannelli isolanti in EPS. Il pannello di comando, comodo e maneggevole, assicura tagli rapidi, precisi e puliti. Staffe per tagliare orientabili per effettuare facilmente tagli obliqui. Ideale da utilizzare su impalcature. Utilizzabile anche come apparecchio da tavolo. | Hot cutter for professional cutting of EPS insulating panels. The convenient, easy-to-use control panel ensures rapid, clean precision cutting. Adjustable brackets make cutting on the diagonal easy. Ideal for use on scaffolding. Can also be used as a table unit. | Cizalla en caliente para el corte profesional de paneles aislantes en EPS. El panel de mando, cómodo y manejable, asegura cortes rápidos, precisos y limpios. Bidas de corte orientables para efectuar fácilmente cortes oblicuos. Ideal para su uso sobre andamio. Utilizable también como aparato de mesa. |
| Lunghezza massima: 105 cm, profondità massima 25 cm. | Maximum Length: 105 cm, maximum depth 25 cm. | Largo máxima: 105 cm, profundidad máxima 25 cm. |



IVAS®

**INDUSTRIA
VERNICI**

DIVISIONE
MALTE TECNICHE

**MAL
TE
TEC
NI
CHE**



ripriisti

prodotti

towerip

towerip 108

towerip colabile

towerip betoncino

towcem

griptow

towerip rapido

towerip & finish



no cls

towerip

scheda
tecnicadata
sheetficha
técnica

| malta fibrorinforzata antiritiro - R3 | interno esterno | anti-shrinkage, fibre- reinforced mortar -R3 | indoor outdoor | mortero fibrorreforzado anti- retracción R3 | interior exterior |
|--|----------------------------|---|---------------------------|---|------------------------------|
| Miscela cementizia pronta all'uso, a base di cementi e sabbie industriali con granulometria max di 1,2 mm, armata con fibre poliammidiche. Idonea per ripristini verticali gli strati applicati risultano di altissima adesione, durabilità, impermeabilità, di eccezionali resistenze meccaniche e agli attacchi chimici, e praticamente privi di ritiro, resistente ai cicli di gelo e disgelo. Per uso professionale. | | Ready to use cement based mixture composed of cement and industrial sands (max. particle size of 1.2 mm) and reinforced with polyamide fibres. Suitable for vertical restorations, the applied layers have very high adhesion, durability, impermeability, exceptional mechanical and chemical resistance, and practically no shrinkage, resistant to freeze and thaw cycles. For professional use. | | Mezcla a base de cemento lista para usar, a base de cementos y arenas industriales; granulometría máx. 1,2 mm, armado con fibras poliamídicas. Adecuado para restauraciones verticales, las capas aplicadas tienen muy alta adherencia, durabilidad, impermeabilidad, excepcional resistencia mecánica y química, y prácticamente ninguna contracción, resistente a los ciclos de congelación y descongelación. Para uso profesional. | |
| Granulometria: max 1,2 mm Attrezzatura: spatola, cazzuola, agitatore a basso numero di giri Rapporto di miscelazione: acqua - 17% Consumo: 19 kg/m ² per cm di spessore Colore: grigio | | Particle size: max 1,2 mm Equipment: spatula, trowel, mechanical low speed mixer Mixing Ratio: water - 17% Coverage: 19 kg/m ² per mm of thickness Color: grey | | Granulometría: max 1,2 mm Herramientas: espátula, paleta, agitador mecánico de bajo número de revoluciones Proporción de mezcla: agua - 17% Consumo: 19 kg/m ² per cm de espesor Color: gris | |

| tecniche | certificazioni | proprietà | tecnologie |
|--|---|-----------|------------|
|  WATER BASED  TROWEL |  | | |

towerip 108

scheda
tecnicadata
sheetficha
técnica

| malta fibrorinforzata antiritiro - R4 | interno esterno | anti-shrinkage, fibre- reinforced mortar -R4 | indoor outdoor | mortero fibrorreforzado anti- retracción - R4 | interior exterior |
|--|----------------------------|---|---------------------------|---|------------------------------|
| Miscela cementizia pronta all'uso, a base di cementi e sabbie industriali con granulometria max di 3 mm, armata con fibre poliammidiche. Idonea per ripristini verticali gli strati applicati risultano di altissima adesione, durabilità, impermeabilità, di eccezionali resistenze meccaniche e agli attacchi chimici, e praticamente privi di ritiro, resistente ai cicli di gelo e disgelo. Per uso professionale. | | Ready to use cement based mixture composed of cement and industrial sands (max. particle size of 3 mm) and reinforced with polyamide fibres. Suitable for vertical restorations, the applied layers have very high adhesion, durability, impermeability, exceptional mechanical and chemical resistance, and practically no shrinkage, resistant to freeze and thaw cycles. For professional use. | | Mezcla a base de cemento lista para usar, a base de cementos y arenas industriales; granulometría máx. 3 mm, armado con fibras poliamídicas. Adecuado para restauraciones verticales, las capas aplicadas tienen muy alta adherencia, durabilidad, impermeabilidad, excepcional resistencia mecánica y química, y prácticamente ninguna contracción, resistente a los ciclos de congelación y descongelación. Para uso profesional. | |
| Granulometria: max 3 mm Attrezzatura: spatola, cazzuola, agitatore a basso numero di giri Rapporto di miscelazione: acqua - 18% Consumo: 18 kg/m ² per cm di spessore Colore: grigio | | Particle size: max 3 mm Equipment: spatula, trowel, mechanical low speed mixer Mixing Ratio: water - 18% Coverage: 18 kg/m ² per mm of thickness Color: grey | | Granulometría: max 3 mm Herramientas: espátula, paleta, agitador mecánico de bajo número de revoluciones Proporción de mezcla: agua - 18% Consumo: 18 kg/m ² per cm de espesor Color: gris | |

| tecniche | certificazioni | proprietà | tecnologie |
|--|---|-----------|------------|
|  WATER BASED  TROWEL |  | | |

towerip colabile



scheda
tecnica



data
sheet



ficha
técnica



| | | | | | |
|---|----------------|---|----------------|---|-----------------|
| malta fluida colabile a ritiro controllato - R4 | esterno | fluid mortar with controlled shrinkage -R4 | outdoor | mortero fluido de contracción controlada - R4 | exterior |
| Miscela cementizia pronta all'uso per ripristini verticali in cassero, a base di cementi e sabbie naturali, armata con fibre polipropilene. Gli strati applicati risultano di altissima adesione, durabilità, impermeabilità, di eccezionali resistenze meccaniche ed agli attacchi chimici, e praticamente priva di ritiro. Per uso professionale. | | Ready-to-use cement-based mixture for vertical repairs in formworks, composed of cements and natural sands and reinforced with polypropylene fibres. The layers applied adhere perfectly and offer durability, impermeability and exceptional mechanical and chemical resistance and are practically free of any shrinkage. For professional use. | | Mezcla de cemento lista para usar para renovaciones verticales sobre encofrado, a base de cementos y arenas naturales, armado con fibras polipropilénicas. Las capas aplicadas ofrecen gran adhesión, durabilidad, impermeabilidad, de excepcionales resistencias mecánicas y a los ataques químicos, prácticamente carentes de retracción. Para uso profesional. | |
| Granulometria: max 3 mm Attrezzatura: spatola, cazzuola, agitatore a basso numero di giri Rapporto di miscelazione: acqua - 15% Consumo: 20 kg/m ² per cm di spessore Colore: grigio | | Particle size: max 3 mm Equipment: spatula, trowel, mechanical low speed mixer Mixing Ratio: water - 15% Coverage: 20 kg/m ² per mm of thickness Color: grey | | Granulometría: max 3 mm Herramientas: espátula, paleta, agitador mecánico de bajo número de revoluciones Proporción de mezcla: agua - 15% Consumo: 20 kg/m ² per cm de espesor Color: gris | |

| tecniche | | | certificazioni | proprietà | | | tecnologie | | |
|----------|--|--|----------------|-----------|--|--|------------|--|--|
| | | | | | | | | | |

towerip betoncino



scheda
tecnica



data
sheet



ficha
técnica



| | | | | | |
|---|----------------|--|----------------|--|-----------------|
| malta tixotropica ad applicazione meccanica - R3 | esterno | thixotropic mortar for mechanical application -R3 | outdoor | mortero tixotrópico para aplicación mecánica - R3 | exterior |
| Malta tixotropica antiritiro per ripristini verticali ad applicazione meccanica, a base di cementi e sabbie industriali con granulometria da 2,5-3 mm, armata con fibre poliammidiche. Idonea per rinforzare strutture deteriorate e per ripristino del calcestruzzo, ripristino di gallerie, piscine, serbatoi. Può essere applicato con prodotti osmotici Towerseal e Towpruf. Per uso professionale. | | Anti-shrinkage thixotropic mortar for vertical repairs applied mechanically. Composed of cement and industrial sands (max. particle size of 2.5-3 mm) and reinforced with polyamide fibres. Suitable to reinforce deteriorated structures and restore concrete, repair tunnels, swimming pools, tanks. Can be applied with the osmotic products Towerseal and Towpruf. For professional use. | | Mortero tixotrópico anti-retracción para renovaciones verticales de aplicación mecánica, a base de cementos y arenas industriales; granulometría 2,5-3 mm, armado con fibras poliamidicas. Idóneo para reforzar estructuras deterioradas y para reacondicionamiento del hormigón, reacondicionamiento de galerías, piscinas, depósitos. Puede aplicarse con productos osmóticos Towerseal y Towpruf. Para uso profesional. | |
| Granulometria: max 3 mm Attrezzatura: spatola, cazzuola, agitatore a basso numero di giri Rapporto di miscelazione: acqua - 14% Consumo: 19 kg/m ² per cm di spessore Colore: grigio | | Particle size: max 3 mm Equipment: spatula, trowel, mechanical low speed mixer Mixing Ratio: water - 14% Coverage: 19 kg/m ² per mm of thickness Color: grey | | Granulometría: max 3 mm Herramientas: espátula, paleta, agitador mecánico de bajo número de revoluciones Proporción de mezcla: agua - 14% Consumo: 19 kg/m ² per cm de espesor Color: gris | |

| tecniche | | | certificazioni | proprietà | | | tecnologie | | |
|----------|--|--|----------------|-----------|--|--|------------|--|--|
| | | | | | | | | | |

towerip rapido

scheda
tecnicadata
sheetficha
técnica

| | | | | | |
|---|----------------------------|---|---------------------------|--|------------------------------|
| malta tixotropica antiritiro a presa rapida - R3 | interno esterno | anti-shrinkage thixotropic mortar - R3 | indoor outdoor | mortero tixotrópico anti-encogimiento - R3 | interior exterior |
| Composto cementizio pronto all'uso, a base di leganti idraulici ed inerti con granulometria max 0,8 mm, armata con fibre poliammidiche, ad altissima adesione, durabilità, impermeabilità, con eccezionali resistenze sia meccaniche che agli attacchi chimici, privo di ritiro. La presa rapida rende questa malta idonea in quei casi ove sia necessario finire il ripristino in tempi brevi e localizzati: pensiline, balconi, ecc. Per uso professionale. | | Ready to use cement compound for vertical repairs composed of hydraulic binders and inert materials (max. particle size 0.8 mm), reinforced with polyamide fibres. It is easy to work. It is highly adhesive, durable, waterproof, has outstanding mechanical and chemical resistance features and does not shrink. The quick setting makes this mortar suitable in those cases where the restoration is to be finished quickly and where the work is localized: shelters, balconies, etc.. For professional use. | | Compuesto de cemento listo para usar con base de aglutinantes hidráulicos y áridos con granulometría máx. 0,8 mm, armado con fibras poliamídicas con altísima adhesión, duración, impermeabilidad, excepcionales resistencias tanto mecánicas como a los ataques químicos, sin retracción. El rápido fraguado hace este mortero idóneo para los casos en que sea necesario terminar la renovación en tiempos breves y localizados: marquesinas, balcones, etc. Para uso profesional. | |
| Granulometria: max 0,8 mm Attrezzatura: spatola, cazzuola, agitatore a basso numero di giri Rapporto di miscelazione: acqua - 19% Consumo: 19 kg/m ² per cm di spessore Colore: grigio | | Particle size: max 0,8 mm Equipment: spatula, trowel, mechanical low speed mixer Mixing Ratio: water - 19% Coverage: 19 kg/m ² per mm of thickness Color: grey | | Granulometría: max 0,8 mm Herramientas: espátula, paleta, agitador mecánico de bajo número de revoluciones Proporción de mezcla: agua - 19% Consumo: 19 kg/m ² per cm de espesor Color: gris | |

| tecniche | | | certificazioni | proprietà | | | tecnologie | | |
|----------|--|--|----------------|-----------|--|--|------------|--|--|
| | | | | | | | | | |

towerip & finish

scheda
tecnicadata
sheetficha
técnica

| | | | | | |
|--|----------------------------|--|---------------------------|---|------------------------------|
| Malta tixotropica per spessori variabili - R3 | interno esterno | thixotropic mortar for varying thicknesses - R3 | indoor outdoor | mortero tixotrópico para espesores variables - R3 | interior exterior |
| Malta cementizia tixotropica fibrorinforzata monocomponente, a presa rapida, costituita da leganti idraulici, aggregati selezionati a granulometria fine, fibre sintetiche in poliacrilonitrile, resine sintetiche e additivi. Idonea per il ripristino e la rasatura del calcestruzzo, applicabile in uno spessore variabile da 3 a 40 mm in una sola mano. Possiede ottima adesione al supporto, elevata stabilità dimensionale, quindi bassi rischi di fessurazioni e cavillature, compatibilità termica ai cicli di gelo e disgelo, bassa permeabilità all'acqua. Per uso professionale. | | One-pack, thixotropic, fast setting, fibre-reinforced cement-based mortar composed of special hydraulic binders, selected fine inert materials, polyacrylonitrile synthetic fibres, synthetic resins and special additives. Ideal for repairing and skimming concrete. Can be applied in thicknesses ranging from 3 to 40 mm in a single coat. Good adhesion to substrate, high dimensional stability, thus there is little risk of cracks and fissures, thermal compatibility for freeze-thaw cycles, low water permeability. For professional use. | | Mortero de cemento tixotrópico fibrorreforzado monocomponente, de fraguado rápido, constituido por aglutinantes hidráulicos especiales, agregados seleccionados de granulometría fina, fibras sintéticas en poliacrilonitrilo, resinas sintéticas y aditivos especiales. Es idóneo para la renovación y el enrasado del hormigón, se aplica con un grosor que puede variar de 3 a 40 mm en una sola mano. Posee excelente adhesión al soporte, alta estabilidad dimensional, que reduce el riesgo de fisuras y cuarteados, compatibilidad térmica con los ciclos de hielo y deshielo, baja permeabilidad al agua. Para uso profesional. | |
| Granulometria: max 0,8 mm Attrezzatura: spatola, cazzuola, agitatore a basso numero di giri Rapporto di miscelazione: acqua - 17-19% Consumo: 15 kg/m ² per cm di spessore Colore: grigio | | Particle size: max 0,8 mm Equipment: spatula, trowel, mechanical low speed mixer Mixing Ratio: water - 17-19% Coverage: 15 kg/m ² per mm of thickness Color: grey | | Granulometría: max 0,8 mm Herramientas: espátula, paleta, agitador mecánico de bajo número de revoluciones Proporción de mezcla: agua - 17-19% Consumo: 15 kg/m ² per cm de espesor Color: gris | |

| tecniche | | | certificazioni | proprietà | | | tecnologie | | |
|----------|--|--|----------------|-----------|--|--|------------|--|--|
| | | | | | | | | | |

towcem



scheda
tecnica



data
sheet



ficha
técnica



| | | | | | |
|---|------------------------|---|-----------------------|---|--------------------------|
| malta rasante a basso spessore - R3 | interno esterno | low thickness skimming mortar - R3 | indoor outdoor | mortero de enrasado de bajo espesor - R3 | interior exterior |
| Miscela cementizia fibrata con granulometria massima di 0,8mm, pronta all'uso perfettamente lavorabile, antiritiro di altissima adesione, impermeabilità e di notevole resistenza meccanica. La malta contiene piccolissime bolle d'aria chiuse che la rendono resistente a cicli di gelo e disgelo. Per uso professionale. | | Fiber-reinforced cement mixture with a maximum grain size of 0.8mm, ready to use, perfectly workable, anti-shrinkage with very high adhesion, impermeability and considerable mechanical resistance. The mortar contains very small closed air bubbles which make it resistant to freeze and thaw cycles. For professional use. | | Mezcla de cemento reforzado con fibras con una granulometría máxima de 0,8 mm, lista para usar, perfectamente trabajable, anti-encogimiento con muy alta adherencia, impenetrabilidad y considerable resistencia mecánica. El mortero contiene burbujas de aire cerradas muy pequeñas que lo hacen resistente a ciclos de congelación y descongelación. Para uso profesional. | |
| Granulometria: max 0,8 mm Attrezzatura: spatola, cazzuola, agitatore a basso numero di giri Rapporto di miscelazione: acqua - 18% Consumo: 1,6 kg/m ² per mm di spessore Colore: grigio | | Particle size: max 0,8 mm Equipment: spatula, trowel, mechanical low speed mixer Mixing Ratio: water - 18% Coverage: 1,6 kg/m ² per mm of thickness Color: grey | | Granulometría: max 0,8 mm Herramientas: espátula, paleta, agitador mecánico de bajo número de revoluciones Proporción de mezcla: agua - 18% Consumo: 1,6 kg/m ² per mm de espesor Color: gris | |

| tecniche | | | certificazioni | proprietà | | | tecnologie | | |
|----------|--|--|----------------|-----------|--|--|------------|--|--|
| | | | | | | | | | |

griptow



scheda
tecnica



data
sheet



ficha
técnica



| | | | | | |
|---|------------------------|---|-----------------------|--|--------------------------|
| boiaccia antiruggine passivante | interno esterno | rustproof, passivating grout | indoor outdoor | mechada antióxido pasivante | interior exterior |
| Prodotto in polvere a base di cementi modificati, inerti selezionati, leganti polimerici alcaliresistenti ed additivi specifici. Appositamente studiato per consentire una perfetta ri-alkalinizzazione o passivazione dei ferri d'armatura nel ripristino del calcestruzzo con malte della linea Towerip. Per uso professionale. | | Powdered product with modified cements, selected inert materials, alkali-resistant polymeric binders and specific additives. Specially designed to allow a perfect re-alkalization or passivation of the reinforcing steel when renovating concrete with mortars from the TOWERIP line. For professional use. | | Producto en polvo a base de cementos modificados, áridos seleccionados, aglutinantes poliméricos resistentes a los álcalis y aditivos específicos. Expresamente estudiado para permitir una perfecta realcalinización o pasivación de los hierros de armadura al restaurar el hormigón con morteros de la línea TOWERIP. Para uso profesional. | |
| Granulometria: max 0,5 mm Attrezzatura: pennello, spatola, impastatrice a basso numero di giri Rapporto di miscelazione: acqua - 32% Consumo: 1,7 kg/m ² per mm di spessore Colore: rossastro | | Particle size: max 0,5 mm Equipment: brush, spatula, low speed mixer Mixing Ratio: water - 32% Coverage: 1,7 kg/m ² per mm of thickness Color: reddish | | Granulometría: max 0,5 mm Herramientas: brocha, espátula, agitador mecánico de bajo número de revoluciones Proporción de mezcla: agua - 32% Consumo: 1,7 kg/m ² per mm de espesor Color: rojizo | |

| tecniche | | | certificazioni | proprietà | | | tecnologie | | |
|----------|--|--|----------------|-----------|--|--|------------|--|--|
| | | | | | | | | | |



rasanti

prodotti

rasaltow max grigio

rasaltow max bianco

rasaltow grigio

rasaltow bianco

rasaltow 108 bianco

rasaltow plus 1.0

rasaltow beton grigio

rasaltow beton bianco

i ht

rasaltow max grigio

scheda
tecnicadata
sheetficha
técnica

| rasante grigio fine universale - 0,5 mm | interno esterno | grey universal fine skim coat, 0.5 mm | indoor outdoor | mortero de enrasado gris fino universal - 0,5 mm | interior exterior |
|--|-----------------|--|----------------|---|-------------------|
| Rasante universale cementizio grigio grana 0,5 mm in polvere idoneo per ottenere finiture di tipo civile fine di ottima qualità su calcestruzzo, intonaci cementizi anche già pitturati, vecchi rivestimenti plastici, solai, predalles. Ideale per realizzare stuccature fino a 20 mm e successiva rasatura anche armata con Rete in Fibra di vetro Armatex C1. Per uso professionale | | Powdered universal grey cement-based skim coat, with 0.5mm grain size, suitable for superb quality fine two-coat finishes on concrete, cement-based plasters, even when already painted, old plastic coatings, floors, and predalles plates. The ideal solution for plastering up to 20 mm thick and subsequent skim coats, also reinforced with Armatex C1 glass fibre mesh. For professional use | | Mortero de cemento universal para enrasado, gris, grano de 0,5 mm, en polvo, adecuado para obtener acabados de revoco fino de excelente calidad sobre hormigón, enfoscados de cemento incluso ya pintados, revestimientos plásticos viejos, forjados, predalles. Ideal para emplastes de hasta 20 mm y posterior enrasado, incluso armado, con malla de fibra de vidrio Armatex C1. Para uso profesional. | |
| Granulometria: max 0,5 mm Attrezzatura: spatola, cazzuola, agitatore a basso numero di giri Rapporto di miscelazione: acqua - 24% Consumo: 1,4 kg/m ² per mm di spessore Colore: grigio | | Particle size: max 0,5 mm Equipment: spatula, trowel, mechanical low speed mixer Mixing Ratio: water - 24% Coverage: 1,4 kg/m ² per mm of thickness Color: grey | | Granulometría: max 0,5 mm Herramientas: espátula, paleta, agitador mecánico de bajo número de revoluciones Proporción de mezcla: agua - 24% Consumo: 1,4 kg/m ² per mm de espesor Color: gris | |

| tecniche | certificazioni | proprietà | tecnologie |
|--|---|-----------|------------|
|  WATER BASED  TROWEL |  EN 1504-2 MC-IR  EN 998-1 GPCS IV | | |

rasaltow max bianco

scheda
tecnicadata
sheetficha
técnica

| rasante bianco fine universale - 0,5 mm | interno esterno | white universal fine skim coat, 0.5 mm | indoor outdoor | mortero de enrasado blanco fino universal - 0,5 mm | interior exterior |
|--|-----------------|--|----------------|---|-------------------|
| Rasante universale cementizio bianco grana 0,5 mm in polvere idoneo per ottenere finiture di tipo civile fine di ottima qualità su calcestruzzo, intonaci cementizi anche già pitturati, vecchi rivestimenti plastici, solai, predalles. Ideale per realizzare stuccature fino a 20 mm e successiva rasatura anche armata con Rete in Fibra di vetro Armatex C1. Per uso professionale | | Powdered universal grey cement-based skim coat, with 0.5mm grain size, suitable for superb quality fine two-coat finishes on concrete, cement-based plasters, even when already painted, old plastic coatings, floors, and predalles plates. The ideal solution for plastering up to 20 mm thick and subsequent skim coats, also reinforced with Armatex C1 glass fibre mesh. For professional use | | Mortero de cemento universal para enrasado, blanco, grano de 0,5 mm, en polvo, adecuado para obtener acabados de revoco fino de excelente calidad sobre hormigón, enfoscados de cemento incluso ya pintados, revestimientos plásticos viejos, forjados, predalles. Ideal para emplastes de hasta 20 mm y posterior enrasado, incluso armado, con malla de fibra de vidrio Armatex C1. Para uso profesional. | |
| Granulometria: max 0,5 mm Attrezzatura: spatola, cazzuola, agitatore a basso numero di giri Rapporto di miscelazione: acqua - 24% Consumo: 1,4 kg/m ² per mm di spessore Colore: bianco | | Particle size: max 0,5 mm Equipment: spatula, trowel, mechanical low speed mixer Mixing Ratio: water - 24% Coverage: 1,4 kg/m ² per mm of thickness Color: white | | Granulometría: max 0,5 mm Herramientas: espátula, paleta, agitador mecánico de bajo número de revoluciones Proporción de mezcla: agua - 24% Consumo: 1,4 kg/m ² per mm de espesor Color: blanco | |

| tecniche | certificazioni | proprietà | tecnologie |
|--|---|-----------|------------|
|  WATER BASED  TROWEL |  EN 1504-2 MC-IR  EN 998-1 GPCS IV | | |

rasaltow grigio



scheda
tecnica



data
sheet



ficha
técnica



| rasante cementizio | interno esterno | cement-based skim coat | indoor outdoor | mortero de cemento | interior exterior |
|--|----------------------------|--|---------------------------|--|------------------------------|
| <p>Rasante cementizio in polvere a base di inerti selezionati, leganti idraulici, copolimeri vinilici ed additivi specifici. Dotato di ottima spatolabilità e riempimento. Idoneo per ottenere finiture di tipo civile di ottima qualità su calcestruzzo, intonaci cementizi anche già pitturati, vecchi rivestimenti plastici, cartongesso, solai, predalles. Adatto per uniformare irregolarità fino a 0,5 cm di spessore e per rasature armate con rete in fibra di vetro con appretto antialcalino. Per uso professionale.</p> | | <p>Powdered cement-based skim coat made of selected inert materials, hydraulic binders, vinyl copolymers and specific additives. With superb spreadability and filling capacity. Suitable for superb quality two-coat finishes on concrete, cement-based plasters, even when already painted, old plastic coatings, plasterboard, floors, predalles plates. Ideal for smoothing out irregularities up to 0.5 cm thick and for glass fibre mesh reinforced skimming with anti-alkaline treatment. For professional use.</p> | | <p>Cemento en polvo rasante a base de inertes seleccionados, aglutinantes hidráulicos, copolímeros vinílicos y aditivos específicos. Dotado de excelente spatolabilidad y llenado. Idóneo para obtener acabados de tipo civil de óptima calidad sobre hormigón, enlucidos de cementos ya pintados, viejos revestimientos plásticos, cartonyeso, losas, predalles. Adecuado para uniformar irregularidades de hasta 0,5 cm de espesor y para el afeitado armado con malla de fibra de vidrio con aplicación antialcalina. Para uso profesional.</p> | |
| <p>Granulometria: max 0,8 mm Attrezzatura: spatola, cazzuola, agitatore a basso numero di giri Rapporto di miscelazione: acqua - 24% Consumo: 1,4 kg/m² per mm di spessore Colore: grigio</p> | | <p>Particle size: max 0,8 mm Equipment: spatula, trowel, mechanical low speed mixer Mixing Ratio: water - 24% Coverage: 1,4 kg/m² per mm of thickness Color: grey</p> | | <p>Granulometría: max 0,8 mm Herramientas: espátula, paleta, agitador mecánico de bajo número de revoluciones Proporción de mezcla: agua - 24% Consumo: 1,4 kg/m² per mm de espesor Color: gris</p> | |

| tecniche | | | certificazioni | | proprietà | | | tecnologie | | |
|----------|--|--|----------------|--|-----------|--|--|------------|--|--|
| | | | | | | | | | | |

rasaltow bianco



scheda
tecnica



data
sheet



ficha
técnica



| rasante cementizio | interno esterno | cement-based skim coat | indoor outdoor | mortero de cemento para enrasado | interior exterior |
|--|----------------------------|---|---------------------------|---|------------------------------|
| <p>Rasante cementizio in polvere a base di inerti selezionati, leganti idraulici, copolimeri vinilici ed additivi specifici. Dotato di ottima spatolabilità e riempimento. Idoneo per ottenere finiture di tipo civile di ottima qualità su calcestruzzo, intonaci cementizi anche già pitturati, vecchi rivestimenti plastici, cartongesso, solai, predalles. Adatto per uniformare irregolarità fino a 0,5 cm di spessore e per rasature armate con rete in fibra di vetro con appretto antialcalino. Per uso professionale.</p> | | <p>Powdered cement-based skim coat made of selected inert materials, hydraulic binders, vinyl copolymers and specific additives. With superb spreadability and filling capacity. Suitable for superb quality two-coat finishes on concrete, cement-based plaster, even if already painted, old plastic coatings, plasterboard, floors, predalles plates. Ideal for smoothing out irregularities up to 0.5 cm thick and for glass fibre mesh reinforced skimming with anti-alkaline treatment. For professional use.</p> | | <p>Mortero de cemento para enrasado en polvo, a base de áridos seleccionados, aglutinantes hidráulicos, copolímeros vinílicos y aditivos específicos. Excelente facilidad para su extensión con espátula y para relleno. Adecuado para obtener acabados de revoco de excelente calidad sobre hormigón, enfoscados de cemento incluso ya pintados, revestimientos plásticos viejos, cartón yeso, forjados, predalles. Adecuado para uniformar irregularidades de hasta 0,5 cm de espesor y para enrasados armados con malla de fibra de vidrio con apresto antialcalino. Para uso profesional.</p> | |
| <p>Granulometria: max 0,8 mm Attrezzatura: spatola, cazzuola, agitatore a basso numero di giri Rapporto di miscelazione: acqua - 24% Consumo: 1,4 kg/m² per mm di spessore Colore: bianco</p> | | <p>Particle size: max 0,8 mm Equipment: spatula, trowel, mechanical low speed mixer Mixing Ratio: water - 24% Coverage: 1,4 kg/m² per mm of thickness Color: white</p> | | <p>Granulometría: max 0,8 mm Herramientas: espátula, paleta, agitador mecánico de bajo número de revoluciones Proporción de mezcla: agua - 24% Consumo: 1,4 kg/m² per mm de espesor Color: blanco</p> | |

| tecniche | | | certificazioni | | proprietà | | | tecnologie | | |
|----------|--|--|----------------|--|-----------|--|--|------------|--|--|
| | | | | | | | | | | |

rasaltow 108 bianco



scheda
tecnica



data
sheet



ficha
técnica



| rasante universale alleggerito con perlite - 1mm | interno esterno | universal skim coat lightened with 1mm beads | indoor outdoor | mortero de enrasado universal aligerado con microperlas - 1mm | interior exterior |
|---|----------------------------|---|---------------------------|---|------------------------------|
| Rasante in polvere a base di resine insaponificabili, cemento portland ad alta resistenza, silicato di alluminio espanso e sabbie selezionate. Possiede ottime caratteristiche adesivanti e resistenza ai cicli di gelo e disgelo. Ottima spatolabilità e riempimento, è specificamente idoneo per rasature, rasature armate a spessore con rete di rinforzo, su intonaci cavillati, cemento armato. Per uso professionale. | | Powder skim coat made of unsaponifiable resins, high resistance Portland cement, expanded aluminium silicate and selected sands. It offers superb adhesive properties and resistance to freeze-thaw cycles. Given its superb filling and applicability properties, Rasaltow 108 is specifically suited to applying skim coats and thick mesh-reinforced skim coats, on cracked plaster and reinforced concrete. For professional use. | | Mortero de enrasado en polvo a base de resinas insaponificables, cemento portland de alta resistencia, silicato de aluminio expandido y arenas seleccionadas. Posee excelentes características de adhesión y resistencia a los ciclos de hielo y deshielo. Rasaltow 108, con excelente facilidad para la extensión con espátula y relleno, es específicamente idóneo para enrasados, enrasados de espesor armados con malla de refuerzo, sobre encostrados cuarteados, hormigón armado. | |
| Granulometria: max 1 mm Attrezzatura: spatola, cazzuola, agitatore a basso numero di giri Rapporto di miscelazione: acqua - 32-34% Consumo: 1 kg/m ² per m di spessore Colore: bianco | | Particle size: max 1 mm Equipment: spatula, trowel, mechanical low speed mixer Mixing Ratio: water - 32-34% Coverage: 1 kg/m ² per mm of thickness Color: white | | Granulometría: max 1 mm Herramientas: espátula, paleta, agitador mecánico de bajo número de revoluciones Proporción de mezcla: agua - 32-34% Consumo: 1 kg/m ² per m de espesor Color: blanco | |

| tecniche | certificazioni | proprietà | tecnologie |
|----------|----------------|-----------|------------|
| | | | |

rasaltow plus 1.0



scheda
tecnica



data
sheet



ficha
técnica



| rasante universale bianco - 1 mm | interno esterno | universal skim coat - 1 mm | indoor outdoor | mortero de enrasado universal - 1 mm | interior exterior |
|---|----------------------------|---|---------------------------|---|------------------------------|
| Rasante universale cementizio grana 1mm in polvere idoneo per ottenere finiture di tipo civile medio di ottima qualità su calcestruzzo, intonaci cementizi anche già pitturati, vecchi rivestimenti plastici, solai, predalles. Ideale per realizzare stuccature fino a 30mm e successiva rasatura armata con Rete in Fibra di vetro Armatex C1. Per interno e esterno. Per uso professionale | | Powdered universal cement-based skim coat, with 1mm grain size, suitable for superb quality medium two-coat finishes on concrete, cement-based plasters, even when already painted, old plastic coatings, plasterboard, floors, predalles plates. The ideal solution for plastering up to 30 mm thick and subsequent skim coats reinforced with Armatex C1 glass fibre mesh. For professional use | | Mortero de cemento universal para enrasado, grano de 1 mm, en polvo, adecuado para obtener acabados de revoco medio de excelente calidad sobre hormigón, encostrados de cemento incluso ya pintados, revestimientos plásticos viejos, cartón-yeso, forjados, predalles. Ideal para realizar emplastes de hasta 30 mm y posteriores enrasados armados con Malla de fibra de vidrio Armatex C1. Para uso profesional. | |
| Granulometria: max 1 mm Attrezzatura: spatola, cazzuola, agitatore a basso numero di giri Rapporto di miscelazione: acqua - 24-26% Consumo: 1,4 kg/m ² per mm di spessore Colore: bianco | | Particle size: max 1 mm Equipment: spatula, trowel, mechanical low speed mixer Mixing Ratio: water - 24-26% Coverage: 1,4 kg/m ² per mm of thickness Color: white | | Granulometría: max 1 mm Herramientas: espátula, paleta, agitador mecánico de bajo número de revoluciones Proporción de mezcla: agua - 24-26% Consumo: 1,4 kg/m ² per mm de espesor Color: blanco | |

| tecniche | certificazioni | proprietà | tecnologie |
|----------|----------------|-----------|------------|
| | | | |

rasaltow beton grigio



scheda
tecnica



data
sheet



ficha
técnica



| | | | | | |
|---|----------------------------|--|---------------------------|---|------------------------------|
| rasante cementizio per CLS - 0,6 mm | interno esterno | cement-based skim coat for concrete - 0,6 mm | indoor outdoor | mortero de cemento para hormigón - 0,6 mm | interior exterior |
| Rasante cementizio in polvere a base di inerti selezionati, leganti idraulici, copolimeri vinilici ed additivi specifici. Idoneo per ottenere finiture di tipo civile di ottima qualità su calcestruzzo liscio, vecchi rivestimenti plastici (tipo graffiato), solai e predalles. Adatto per uniformare irregolarità fino a 5 mm di spessore e per rasature armate con rete in fibra di vetro con appretto antialcalino. Per uso professionale. | | Powdered cement-based skim coat made of selected inert materials, hydraulic binders, vinyl copolymers and specific additives. Suitable for superb quality two-coat finishes on smooth concrete, old plastic coatings (with scratched effect), floors, and predalles plates. Ideal for smoothing out irregularities up to 5 mm thick and for glass fibre mesh reinforced skimming with anti-alkaline treatment. For professional use. | | Mortero de cemento para enrasado en polvo, a base de áridos seleccionados, aglutinantes hidráulicos, copolímeros vinílicos y aditivos específicos. Adecuado para obtener acabados de revoco de excelente calidad sobre hormigón liso, revestimientos plásticos viejos (efecto rayado), forjados y predalles. Adecuado para uniformar irregularidades de hasta 5 mm de espesor y para enrasados armados con malla de fibra de vidrio con apresto antialcalino. | |
| Granulometria: max 0,6 mm Attrezzatura: spatola, cazzuola, agitatore a basso numero di giri Rapporto di miscelazione: acqua - 22-25% Consumo: 1,4 kg/m ² per mm di spessore Colore: grigio | | Particle size: max 0,6 mm Equipment: spatula, trowel, mechanical low speed mixer Mixing Ratio: water - 22-25% Coverage: 1,4 kg/m ² per mm of thickness Color: grey | | Granulometría: max 0,6 mm Herramientas: espátula, paleta, agitador mecánico de bajo número de revoluciones Proporción de mezcla: agua - 22-25% Consumo: 1,4 kg/m ² per mm de espesor Color: gris | |

| tecniche | | | certificazioni | | | proprietà | | | tecnologie | | |
|----------|--|--|----------------|--|--|-----------|--|--|------------|--|--|
| | | | | | | | | | | | |

rasaltow beton bianco



scheda
tecnica



data
sheet



ficha
técnica



| | | | | | |
|---|----------------------------|--|---------------------------|---|------------------------------|
| rasante cementizio per CLS - 0,6 mm | interno esterno | cement-based skim coat for concrete - 0,6 mm | indoor outdoor | mortero de cemento para hormigón - 0,6 mm | interior exterior |
| Rasante cementizio in polvere a base di inerti selezionati, leganti idraulici, copolimeri vinilici ed additivi specifici. Idoneo per ottenere finiture di tipo civile di ottima qualità su calcestruzzo liscio, vecchi rivestimenti plastici (tipo graffiato), solai e predalles. Adatto per uniformare irregolarità fino a 5 mm di spessore e per rasature armate con rete in fibra di vetro con appretto antialcalino. Per uso professionale. | | Powdered cement-based skim coat made of selected inert materials, hydraulic binders, vinyl copolymers and specific additives. Suitable for superb quality two-coat finishes on smooth concrete, old plastic coatings (with scratched effect), floors, and predalles plates. Ideal for smoothing out irregularities up to 5 mm thick and for glass fibre mesh reinforced skimming with anti-alkaline treatment. For professional use. | | Mortero de cemento para enrasado en polvo, a base de áridos seleccionados, aglutinantes hidráulicos, copolímeros vinílicos y aditivos específicos. Adecuado para obtener acabados de revoco de excelente calidad sobre hormigón liso, revestimientos plásticos viejos (efecto rayado), forjados y predalles. Adecuado para uniformar irregularidades de hasta 5 mm de espesor y para enrasados armados con malla de fibra de vidrio con apresto antialcalino. Para uso profesional. | |
| Granulometria: max 0,6 mm Attrezzatura: spatola, cazzuola, agitatore a basso numero di giri Rapporto di miscelazione: acqua - 22-25% Consumo: 1,4 kg/m ² per mm di spessore Colore: bianco | | Particle size: max 0,6 mm Equipment: spatula, trowel, mechanical low speed mixer Mixing Ratio: water - 22-25% Coverage: 1,4 kg/m ² per mm of thickness Color: white | | Granulometría: max 0,6 mm Herramientas: espátula, paleta, agitador mecánico de bajo número de revoluciones Proporción de mezcla: agua - 22-25% Consumo: 1,4 kg/m ² per mm de espesor Color: blanco | |

| tecniche | | | certificazioni | | | proprietà | | | tecnologie | | |
|----------|--|--|----------------|--|--|-----------|--|--|------------|--|--|
| | | | | | | | | | | | |



rasanti

prodotti

tow bn anticarbonatazione

tow bk grigio

tow bk bianco

tow bf

uniform grigio

uniform bianco

tow bn r grigio

tow bn r bianco

tow bn anticarbonatazione

scheda
tecnicadata
sheetficha
técnica

| | | | | | |
|--|------------------------|---|-----------------------|--|--------------------------|
| finitura a civile fine anticarbonatazione - 0,6 mm | interno esterno | anti-carbonation fine two-coat finish - 0,6 mm | indoor outdoor | acabado de revoco fino anticarbonatación - 0,6 mm | interior exterior |
| Rasante cementizio anticarbonatazione grana 0,6 mm in polvere a base di inerti selezionati, leganti idraulici, copolimeri vinilici ed additivi atti ad impedire la carbonatazione del calcestruzzo. Dotato di ottima spatolabilità e riempimento, idoneo per rasare calcestruzzo, intonaci cementizi stagionati, solai. Per uso professionale. | | Powdered cement-based anti-carbonation skim coat 0,6 mm made of selected inert materials, hydraulic binders, vinyl copolymers and specific additives to prevent carbonation of the concrete. With superb spreadability and filling capacity, suitable for levelling concrete, set cement-based plasters, predalles, floors and to smooth out irregularities up to 1 cm thick. For professional use. | | Mortero de enrasado de cemento anticarbonatación en polvo 0,6mm a base de áridos seleccionados, aglutinantes hidráulicos, copolímeros vinilicos y aditivos idóneos para impedir la carbonatación del hormigón. Dotado de excelente facilidad para aplicación con espátula y relleno, idóneo para enrasar hormigón, enfoscados de cemento fraguados, predalles y forjados, así como para uniformar irregularidades hasta 1 cm de espesor. Para uso profesional. | |
| Granulometria: max 0,6 mm Attrezzatura: spatola, cazzuola, agitatore a basso numero di giri Rapporto di miscelazione: acqua - 18-20% Consumo: 1,5 kg/m ² per mm di spessore Colore: grigio | | Particle size: max 0,6 mm Equipment: spatula, trowel, mechanical low speed mixer Mixing Ratio: water - 18-20% Coverage: 1,5 kg/m ² per mm of thickness Color: grey | | Granulometría: max 0,6 mm Herramientas: espátula, paleta, agitador mecánico de bajo número de revoluciones Proporción de mezcla: agua - 18-20% Consumo: 1,5 kg/m ² per mm de espesor Color: gris | |

| tecniche | certificazioni | proprietà | tecnologie |
|--|---|-----------|------------|
|  WATER BASED  TROWEL |  | | |

tow bk grigio

scheda
tecnicadata
sheetficha
técnica

| | | | | | |
|---|------------------------|---|-----------------------|---|--------------------------|
| finitura a civile media per CLS -1,2 mm | interno esterno | medium two-coat finish for concrete - 1,2 mm | indoor outdoor | acabado de revoco medio para hormigón -1,2 mm | interior exterior |
| Rasante cementizio in polvere grana 1,2 mm a base di inerti selezionati, leganti idraulici, copolimeri vinilici ed additivi specifici. Dotato di ottima spatolabilità e riempimento, idoneo per rasare calcestruzzo, intonaci cementizi stagionati, solai; per effettuare il riempimento dei giunti delle predalles, per uniformare irregolarità fino ad 1 cm di spessore. Per interno ed esterno. Per uso professionale. | | Powdered cement-based skim coat grain size 1.2 mm made of selected inert materials, hydraulic binders, vinyl copolymers and specific additives. Has superb spreadability and filling capacity. Ideal for skimming concrete, set cement-based plaster, floors; for filling joints between predalles, smoothing out irregularities up to 1cm thick. For professional use. | | Mortero de cemento para enrasado en polvo tamaño de grano 1,2 mm, con base de áridos seleccionados, aglutinantes hidráulicos, copolímeros vinilicos y aditivos específicos. Dotado de excelente facilidad para aplicación con espátula y para relleno, idóneo para enrasar hormigón, enfoscados de cemento fraguados, forjados; para efectuar el relleno de las juntas de los predalles, para uniformar irregularidades de hasta 1 cm de espesor. Para uso profesional. | |
| Granulometria: max 1,2 mm Attrezzatura: spatola, cazzuola, agitatore a basso numero di giri Rapporto di miscelazione: acqua - 20-22% Consumo: 1,4 kg/m ² per mm di spessore Colore: grigio | | Particle size: max 1,2 mm Equipment: spatula, trowel, mechanical low speed mixer Mixing Ratio: water - 20-22% Coverage: 1,4 kg/m ² per mm of thickness Color: grey | | Granulometría: max 1,2 mm Herramientas: espátula, paleta, agitador mecánico de bajo número de revoluciones Proporción de mezcla: agua - 20-22% Consumo: 1,4 kg/m ² per mm de espesor Color: gris | |

| tecniche | certificazioni | proprietà | tecnologie |
|--|--|-----------|------------|
|  WATER BASED  TROWEL |   | | |

tow bk bianco



scheda
tecnica



data
sheet



ficha
técnica



| | | | | | |
|--|------------------------|---|-----------------------|---|--------------------------|
| finitura a civile media per CLS -1,2 mm | interno esterno | medium two-coat finish for concrete - 1.2 mm | indoor outdoor | acabado de revoco medio para hormigón-1,2 mm | interior exterior |
| Rasante cementizio bianco in polvere grana 1,2 mm a base di inerti selezionati, leganti idraulici, copolimeri vinilici ed additivi specifici. Dotato di ottima spatolabilità e riempimento, idoneo per rasare calcestruzzo, intonaci cementizi stagionati, solai; per effettuare il riempimento dei giunti delle predalles, per uniformare irregolarità fino ad 1 cm di spessore. Per uso professionale. | | Powdered cement-based skim coat grain size 1.2 mm made of selected inert materials, hydraulic binders, vinyl copolymers and specific additives. Has superb spreadability and filling capacity. Ideal for skimming concrete, set cement-based plaster, floors; for filling joints between predalles, smoothing out irregularities up to 1cm thick. For professional use. | | Mortero de cemento para enrasado en polvo tamaño de grano 1,2 mm, con base de áridos seleccionados, aglutinantes hidráulicos, copolímeros vinílicos y aditivos específicos. Dotado de excelente facilidad para aplicación con espátula y para relleno, idóneo para enrasar hormigón, enfoscados de cemento fraguados, forjados; para efectuar el relleno de las juntas de los predalles, para uniformar irregularidades de hasta 1 cm de espesor. Para uso profesional. | |
| Granulometria: max 1,2 mm Attrezzatura: spatola, cazzuola, agitatore a basso numero di giri Rapporto di miscelazione: acqua - 20-22% Consumo: 1,4 kg/m ² per mm di spessore Colore: bianco | | Particle size: max 1,2 mm Equipment: spatula, trowel, mechanical low speed mixer Mixing Ratio: water - 20-22% Coverage: 1,4 kg/m ² per mm of thickness Color: white | | Granulometría: max 1,2 mm Herramientas: espátula , paleta, agitador mecánico de bajo número de revoluciones Proporción de mezcla: agua - 20-22% Consumo: 1,4 kg/m ² per mm de espesor Color: blanco | |

| tecniche | | | certificazioni | | proprietà | | | | tecnologie | | | |
|----------|--|--|----------------|--|-----------|--|--|--|------------|--|--|--|
| | | | | | | | | | | | | |

tow bf



scheda
tecnica



data
sheet



ficha
técnica



| | | | | | |
|--|------------------------|--|-----------------------|---|--------------------------|
| rasante a finitura liscia | interno esterno | smooth-finish skim coat | indoor outdoor | mortero de enrasado de acabado liso | interior exterior |
| Rasante a finitura estremamente liscia, cementizio in polvere a base di inerti selezionati, leganti idraulici, copolimeri vinilici ed additivi specifici, dotato di ottima spatolabilità. Idoneo per rasare calcestruzzo, intonaci cementizi stagionati, predalles e come finitura per i rasanti Tow BK o Tow BN. Per interno ed esterno. Per uso professionale. | | Extremely smooth powdered cement-based skim coat made of selected inert materials, hydraulic binders, vinyl copolymers and specific additives offering superb trowel applicability. Suitable to skim concrete, set cement-based plaster, predalles plates, as finishing for Tow BK or Tow BN skim coats. For professional use. | | Mortero de enrasado de acabado extremadamente liso, de cemento en polvo a base de áridos seleccionados, aglutinantes hidráulicos, copolímeros vinílicos y aditivos específicos, dotado de excelente facilidad para la aplicación con espátula. Idóneo para enrasar hormigón, enfoscados de cemento fraguados, predalles y como acabado para los morteros de enrasado Tow BK o Tow BN. Para uso profesional. | |
| Granulometria: max 0,1 mm Attrezzatura: spatola, cazzuola, impastatrice a basso numero di giri Rapporto di miscelazione: acqua - 40% Consumo: 1,3 kg/m ² per mm di spessore Colore: bianco | | Particle size: max 0,1 mm Equipment: spatula, trowel, low speed mixer Mixing Ratio: water - 40% Coverage: 1,3 kg/m ² per mm of thickness Color: white | | Granulometría: max 0,1 mm Herramientas: espátula , paleta, agitador mecánico de bajo número de revoluciones Proporción de mezcla: agua - 40% Consumo: 1,3 kg/m ² per mm de espesor Color: blanco | |

| tecniche | | | certificazioni | | proprietà | | | | tecnologie | | | |
|----------|--|--|----------------|--|-----------|--|--|--|------------|--|--|--|
| | | | | | | | | | | | | |

uniform grigio

scheda
tecnicadata
sheetficha
técnica

| | | | | | |
|--|----------------------------|--|---------------------------|---|------------------------------|
| rasante fibrorinforzato uniformante - 0,6 mm | interno esterno | uniforming fibre- reinforced skim coat - 0,6 mm | indoor outdoor | mortero de enrasado fibrorreforzado uniformante - 0,6 mm | interior exterior |
| Rasante fibrorinforzato uniformante grigio grana 0,6 mm. Idoneo per rasare e stuccare intonaci cementizi vecchi (non sfarinanti), stagionati e nuovi. Permette di ottenere finiture di tipo a civile. Lo spessore massimo per una singola mano è di 3 mm; per ottenere spessori maggiori è necessario interporre tra la prima e la seconda mano una rete in fibra di vetro alcaloresistente Armatex C1. Per interno ed esterno. Per uso professionale. | | Uniforming fibre-reinforced grey skim coat, with 0,6mm grain size. Suitable for skimming and filling old cement-based plasters (when not chalky), set plaster and new plaster. Achieves two-coat finishes. The maximum thickness of a single coat is 3 mm; greater thicknesses require installing an alkali-resistant glass fibre Armatex C1 mesh between the first and second coat. For professional use. | | Mortero de enrasado fibrorreforzado uniformante gris de grano 0,6 mm. Idóneo para enrasar y emplastar enfoscados de cemento viejos (sin desintegración pulverulenta), fraguados y nuevos. Permite obtener acabados de revoco. El espesor máximo para una sola mano es de 3 mm; para obtener espesores mayores es necesario interponer entre la primera y la segunda mano una malla de fibra de vidrio alcalino-resistente Armatex C1. Para uso profesional. | |
| Granulometria: max 0,6 mm Attrezzatura: spatola, cazzuola, agitatore a basso numero di giri Rapporto di miscelazione: acqua - 22-24% Consumo: 1,5 kg/m ² per mm di spessore Colore: grigio | | Particle size: max 0,6 mm Equipment: spatula, trowel, mechanical low speed mixer Mixing Ratio: water - 22-24% Coverage: 1,5 kg/m ² per mm of thickness Color: grey | | Granulometría: max 0,6 mm Herramientas: espátula, paleta, agitador mecánico de bajo número de revoluciones Proporción de mezcla: agua - 22-24% Consumo: 1,5 kg/m ² per mm de espesor Color: gris | |

| tecniche | certificazioni | proprietà | tecnologie |
|--|---|-----------|------------|
|  WATER BASED  TROWEL |  EN 998-1 GPCS II | | |

uniform bianco

scheda
tecnicadata
sheetficha
técnica

| | | | | | |
|--|----------------------------|--|---------------------------|---|------------------------------|
| rasante fibrorinforzato uniformante - 0,6 mm | interno esterno | uniforming fibre- reinforced skim coat - 0,6 mm | indoor outdoor | mortero de enrasado fibrorreforzado uniformante - 0,6 mm | interior exterior |
| Rasante fibrorinforzato uniformante bianco grana 0,6 mm. Idoneo per rasare e stuccare intonaci cementizi vecchi (non sfarinanti), stagionati e nuovi. Permette di ottenere finiture di tipo a civile. Lo spessore massimo per una singola mano è di 3 mm; per ottenere spessori maggiori è necessario interporre tra la prima e la seconda mano una rete in fibra di vetro alcaloresistente Armatex C1. Per uso professionale. | | Uniforming fibre-reinforced grey skim coat, with 0,6mm grain size. Suitable for skimming and filling old cement-based plasters (when not chalky), set plaster and new plaster. Achieves two-coat finishes. The maximum thickness of a single coat is 3 mm; greater thicknesses require installing an alkali-resistant glass fibre Armatex C1 mesh between the first and second coat. For professional use. | | Mortero de enrasado fibrorreforzado uniformante gris de grano 0,6 mm. Idóneo para enrasar y emplastar enfoscados de cemento viejos (sin desintegración pulverulenta), fraguados y nuevos. Permite obtener acabados de revoco. El espesor máximo para una sola mano es de 3 mm; para obtener espesores mayores es necesario interponer entre la primera y la segunda mano una malla de fibra de vidrio alcalino-resistente Armatex C1. Para uso profesional. | |
| Granulometria: max 0,6 mm Attrezzatura: spatola, cazzuola, agitatore a basso numero di giri Rapporto di miscelazione: acqua - 22-24% Consumo: 1,5 kg/m ² per mm di spessore Colore: bianco | | Particle size: max 0,6 mm Equipment: spatula, trowel, mechanical low speed mixer Mixing Ratio: water - 22-24% Coverage: 1,5 kg/m ² per mm of thickness Color: white | | Granulometría: max 0,6 mm Herramientas: espátula, paleta, agitador mecánico de bajo número de revoluciones Proporción de mezcla: agua - 22-24% Consumo: 1,5 kg/m ² per mm de espesor Color: blanco | |

| tecniche | certificazioni | proprietà | tecnologie |
|--|---|-----------|------------|
|  WATER BASED  TROWEL |  EN 998-1 GPCS II | | |

tow bn r grigio



scheda
tecnica



data
sheet



ficha
técnica



| rasante a finitura civile fine - 0,6 mm | interno esterno | fine two-coat finish skim coat - 0.6 mm | indoor outdoor | rasante a acabado civile fine - 0,6 mm | interior exterior |
|--|----------------------------|--|---------------------------|---|------------------------------|
| Rasante cementizio grigio in polvere grana 0,6 mm a base di inerti selezionati, leganti aerei, idraulici ed additivi specifici. Dotato di ottima spatolabilità e riempimento, idoneo per la rasatura di intonaci nuovi interni ed esterni. Spessore massimo applicabile a due mani: 5 mm. Per uso professionale. | | Powdered cement-based grey skim coat, with 0.6mm grain size, made of selected inert materials, hydraulic and air binders, and specific additives. With superb spreadability and filling capacity, ideal for skimming new indoor and outdoor plasters. Maximum applicable thickness with two coats: 5 mm. For professional use. | | Rasante cementicio gris en polvo grano 0,6 mm a base de inertes seleccionados, aglutinantes aéreos, hidráulicos y aditivos específicos. Dotado de excelente espatulabilidad y llenado, idóneo para el afeitado de nuevos enlucidos internos y externos. Espesor máximo aplicable a dos manos: 5 mm. Para uso profesional. | |
| Granulometria: max 0,6 mm Attrezzatura: spatola, cazzuola, agitatore a basso numero di giri Rapporto di miscelazione: acqua - 22-24% Consumo: 1,5 kg/m ² per mm di spessore Colore: grigio | | Particle size: max 0,6 mm Equipment: spatula, trowel, mechanical low speed mixer Mixing Ratio: water - 22-24% Coverage: 1,5 kg/m ² per mm of thickness Color: grey | | Granulometría: max 0,6 mm Herramientas: espátula, paleta, agitador mecánico de bajo número de revoluciones Proporción de mezcla: agua - 22-24% Consumo: 1,5 kg/m ² per mm de espesor Color: gris | |

| tecniche | | certificazioni | proprietà | | | | tecnologie | | | |
|----------|--|----------------|-----------|--|--|--|------------|--|--|--|
| | | | | | | | | | | |

tow bn r bianco



scheda
tecnica



data
sheet



ficha
técnica



| rasante a finitura civile fine - 0,6 mm | interno esterno | fine two-coat finish skim coat - 0.6 mm | indoor outdoor | rasante a acabado civile fine - 0,6 mm | interior exterior |
|--|----------------------------|--|---------------------------|---|------------------------------|
| Rasante cementizio grigio in polvere grana 0,6 mm a base di inerti selezionati, leganti aerei, idraulici ed additivi specifici. Dotato di ottima spatolabilità e riempimento, idoneo per la rasatura di intonaci nuovi interni ed esterni. Spessore massimo applicabile a due mani: 5 mm. Per uso professionale. | | Powdered cement-based grey skim coat, with 0.6mm grain size, made of selected inert materials, hydraulic and air binders, and specific additives. With superb spreadability and filling capacity, ideal for skimming new indoor and outdoor plasters. Maximum applicable thickness with two coats: 5 mm. For professional use. | | Rasante cementicio gris en polvo grano 0,6 mm a base de inertes seleccionados, aglutinantes aéreos, hidráulicos y aditivos específicos. Dotado de excelente espatulabilidad y llenado, idóneo para el afeitado de nuevos enlucidos internos y externos. Espesor máximo aplicable a dos manos: 5 mm. Para uso profesional. | |
| Granulometria: max 0,6 mm Attrezzatura: spatola, cazzuola, agitatore a basso numero di giri Rapporto di miscelazione: acqua - 22-24% Consumo: 1,5 kg/m ² per mm di spessore Colore: bianco | | Particle size: max 0,6 mm Equipment: spatula, trowel, mechanical low speed mixer Mixing Ratio: water - 22-24% Coverage: 1,5 kg/m ² per mm of thickness Color: white | | Granulometría: max 0,6 mm Herramientas: espátula, paleta, agitador mecánico de bajo número de revoluciones Proporción de mezcla: agua - 22-24% Consumo: 1,5 kg/m ² per mm de espesor Color: blanco | |

| tecniche | | certificazioni | proprietà | | | | tecnologie | | | |
|----------|--|----------------|-----------|--|--|--|------------|--|--|--|
| | | | | | | | | | | |



calce n

prodotti

asfodelo rinzaffo antisale

asfodelo

asfodelo risanante

asfodelo 530 bianco

artemisia

artemisia rasopietra

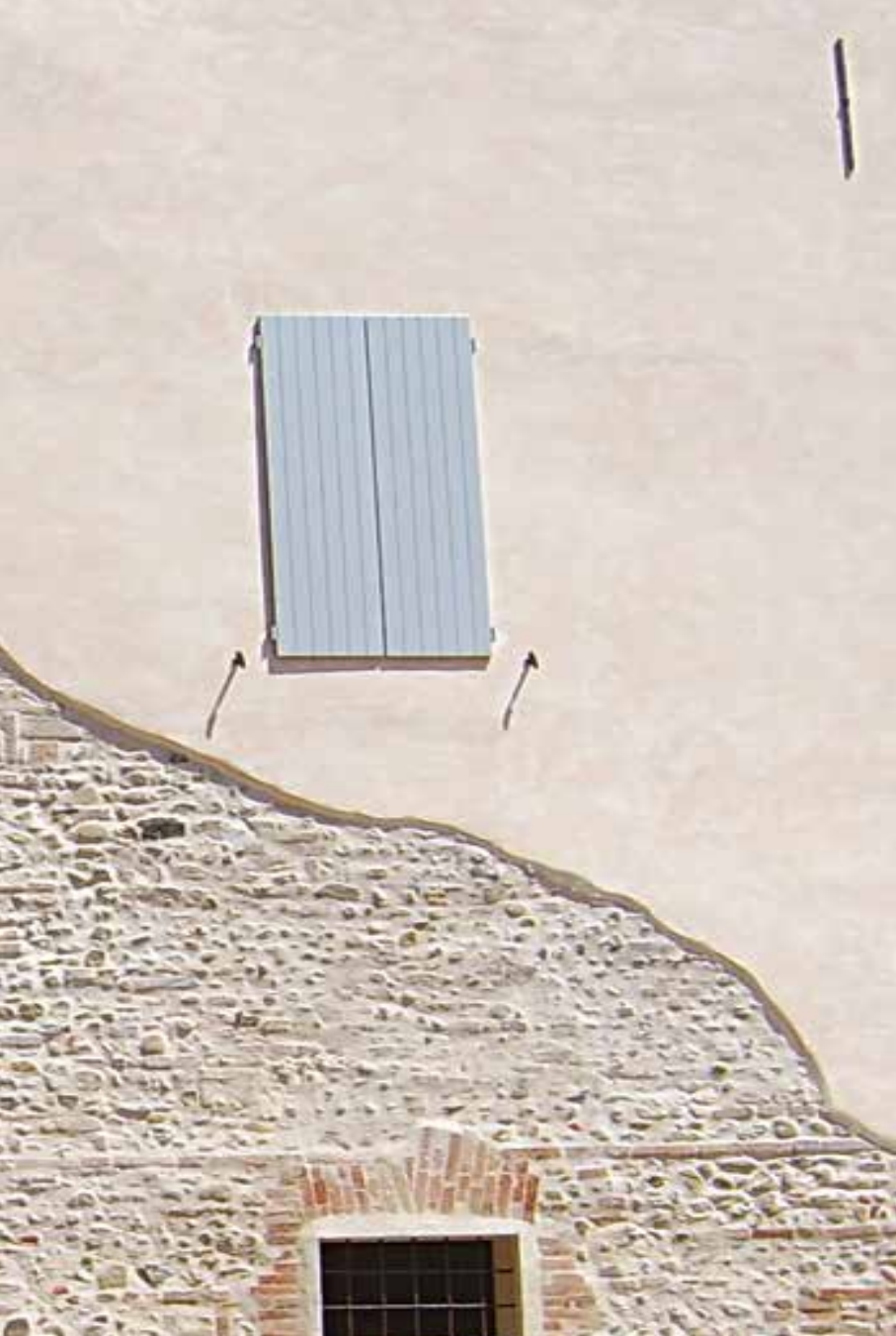

aturale

asfodelo rinzafo antisale



scheda
tecnica



data
sheet



ficha
técnica



| | | | | | |
|---|------------------------|--|-----------------------|--|--------------------------|
| malta da rinzafo antisale base calce idraulica - 3 mm | interno esterno | hydraulic lime-based anti-salt rough coat mortar - 3 mm | indoor outdoor | mortero de repello antisal a base de cal apagada - 3 mm | interior exterior |
| Malta da rinzafo Color Nocciola specifica per la realizzazione di rinzafo antisale a base di calce idraulica pura. Composta da calce idraulica, sabbie selezionate e additivi specifici atti a conferire al prodotto la caratteristica di "filtro antisale" e controllano il passaggio dei sali idrosolubili quali cloruri, nitrati e solfati eventualmente presenti nella muratura. Per uso professionale. | | Hydraulic lime-based mortar specific for anti-salt rough coats. Composed of hydraulic lime, selected sands and specific additives that give the product "anti-salt filter" properties and control the passage of water-soluble salts such as chlorides, nitrates and sulphates that may be present in the masonry. For professional use. | | Mortero de repellido específico para la realización de repello antisal a base de cal hidráulica pura. Compuesto de cal hidráulica, arenas seleccionadas y aditivos específicos con función de dar al producto la característica de "filtro antisal" y controlar el paso de sales hidrosolubles como cloruros, nitratos y sulfatos que pudieran existir en las paredes. Para uso profesional. | |
| Granulometria: max 2,5 mm Attrezzatura: spatola, cazzuola, betoniera, agitatore a basso numero di giri Rapporto di miscelazione: acqua - 22% Consumo: 15 kg/m ² per cm di spessore Colore: nocciola | | Particle size: max 2,5 mm Equipment: spatula, trowel, cement mixer, mechanical low speed mixer Mixing Ratio: water - 22% Coverage: 15 kg/m ² per mm of thickness Color: hazelnut | | Granulometría: max 2,5 mm Herramientas: espátula, paleta, hormigonera, agitador mecánico de bajo número de revoluciones Proporción de mezcla: agua - 22% Consumo: 15 kg/m ² per cm de espesor Color: avellanado | |

| tecniche | certificazioni | proprietà | tecnologie |
|--|---|-----------|------------|
|   |  | | |

asfodelo



scheda
tecnica



data
sheet



ficha
técnica



| | | | | | |
|--|------------------------|--|-----------------------|---|--------------------------|
| intonaco premiscelato base calce idraulica - 1,2 mm | interno esterno | hydraulic lime-based plaster premix, 1,2 mm | indoor outdoor | enfoscado premezclado a base de cal hidráulica - 1,2 mm | interior exterior |
| Intonaco premiscelato Color Nocciola a base di calce idraulica naturale NHL 5 (conforme alla norma EN 459:2010), pozzolana micronizzata ed inerti selezionati. Appositamente studiato per un'ottima lavorabilità con applicazione meccanica. Adatto per intonaci interni ed esterni ecologici e di edifici di interesse storico e culturale. Spessore massimo applicabile 15 mm per mano. Per uso professionale. | | Plaster premix based on natural hydraulic lime NHL 5 (in compliance with EN 459:2010), micronized pozzolana and selected inert materials, specifically designed for rational application. Suitable for eco-friendly plasters for indoor and outdoor application and for those of historic and cultural buildings. Maximum applicable thickness 15 mm per coat. For professional use. | | Enfoscado premezclado a base de cal hidráulica natural NHL 5 (conforme a la norma EN 459:2010), puzolana micronizada y áridos seleccionados, expresamente estudiado para una aplicación racional. Idóneo para enfoscados internos y externos, ecológicos y de edificios de interés histórico y cultural. Espesor máximo aplicable 15 mm por mano. Para uso profesional. | |
| Granulometria: max 1,2 mm Attrezzatura: spatola, frattazzo, intonacatrice meccanica, staggia, rabotto Rapporto di miscelazione: acqua - 20% Consumo: 14 kg/m ² per cm di spessore Colore: nocciola | | Particle size: max 1,2 mm Equipment: spatula, trowel, mechanical plastering machine, levelling bar, plaster plane Mixing Ratio: water - 20% Coverage: 14 kg/m ² per mm of thickness Color: hazelnut | | Granulometría: max 1,2 mm Herramientas: espátula, frattazzo, enfo-scadora mecánica, sregla, rabot Proporción de mezcla: agua - 20% Consumo: 14 kg/m ² per cm de espesor Color: avellanado | |

| tecniche | certificazioni | proprietà | tecnologie |
|--|---|-----------|------------|
|    |  | | |

artemisia

scheda
tecnicadata
sheetficha
técnica

| | | | | | |
|---|----------------------------|--|---------------------------|--|------------------------------|
| rasante di finitura fine a base calce - 0,6 mm | interno esterno | lime-based fine finish skim coat - 0.6 mm | indoor outdoor | mortero de enrasado para acabados finos a base de cal - 0,6 mm | interior exterior |
| Stucco rasante, a base di calce idrata e calce idraulica naturale NHL 5, inerti selezionati ed additivi specifici. Dotato di ottima spatolabilità e riempimento, idoneo per la rasatura di interni ed esterni, estremamente versatile per la facilità d'uso nelle riprese. Ideale come finitura per intonaci ecologici ed edifici di interesse storico culturale. Finitura civile, fine. Spessore massimo 3 mm con opzione di rete di armatura Armatex C1. Per uso professionale. | | Hydrated and natural hydraulic NHL 5 lime-based skimming plaster containing selected inert materials and specific additives. With superb spreadability and filling capacity, ideal for skimming indoor and outdoor surfaces, extremely versatile given the ease with which it can be used in joints. Ideal as a topcoat for eco-friendly plasters and for historic and cultural buildings. Fine, two-coat finish. Maximum thickness: 3 mm. For professional use. | | Emplaste de enrasado a base de cal apagada y cal hidráulica natural NHL 5, áridos seleccionados y aditivos específicos. Excelente facilidad para la extensión con espátula y relleno, ideal para el enrasado de interior y exteriores, extremadamente versátil por la facilidad de uso tras las interrupciones. Ideal como acabado para enfoscados ecológicos y edificios de interés histórico cultural. Acabados de revoco, finos. Espesor máximo 3 mm. Para uso profesional. | |
| Granulometria: max 0,6 mm Attrezzatura: spatola, cazzuola, frattazzo, impastatrice a basso numero di giri Rapporto di miscelazione: acqua - 30-32% Consumo: 1,4 kg/m ² per mm di spessore Colore: nocciola | | Particle size: max 0,6 mm Equipment: spatula, trowel, trowel, low speed mixer Mixing Ratio: water - 30-32% Coverage: 1,4 kg/m ² per mm of thickness Color: hazelnut | | Granulometría: max 0,6 mm Herramientas: espátula, paleta, frattazzo, agitador mecánico de bajo número de revoluciones Proporción de mezcla: agua - 30-32% Consumo: 1,4 kg/m ² per mm de espesor Color: avellanado | |

| tecniche | certificazioni | proprietà | tecnologie |
|--|---|-----------|------------|
|   |  | | |

artemisia rasopietra

scheda
tecnicadata
sheetficha
técnica

| | | | | | |
|--|----------------------------|---|---------------------------|--|------------------------------|
| malta per stuccature base calce - 1,2 mm | interno esterno | lime-based mortar for plastering - 1.2 mm | indoor outdoor | mortero para emplas- tes a base de cal - 1,2 mm | interior exterior |
| Malta premiscelata idrofugata a base di calce idraulica naturale adatta per la stuccatura o il ripristino delle fughe di mattoni, pietra o tufo. Particolarmente idoneo per edifici storici, caSolar di campagna, ecc. Per uso professionale. | | Natural hydraulic lime-based waterproofed mortar, suitable for plastering stone or tuff. Particularly suitable for historic buildings, country houses, etc.. For professional use. | | Mortero preenvasado hidrófugo a base de cal hidráulica natural, idónea para el estucado de piedra o toba. Particolarmente idóneo para edificios antiguos, caseríos, etc.. Para uso profesional. | |
| Granulometria: max 1,5 mm Attrezzatura: spatola, cazzuola, impastatrice a basso numero di giri o betoniera Rapporto di miscelazione: acqua - 20% Consumo: 2 kg/m ² per mm di spessore Colore: Terra di Siena bruciata, Nocciola, Giallo antico | | Particle size: max 1,5 mm Equipment: spatula, trowel, low speed mixer o cement mixer Mixing Ratio: water - 20% Coverage: 2 kg/m ² per mm of thickness Color: burnt Sienna, hazelnut, antique yellow | | Granulometría: max 1,5 mm Herramientas: espátula, paleta, agitador mecánico de bajo número de revoluciones o hormigonera Proporción de mezcla: agua - 20% Consumo: 2 kg/m ² per mm de espesor Color: terra di Siena bruciata, avellana, amarillo antiguo | |

| tecniche | certificazioni | proprietà | tecnologie |
|--|---|-----------|------------|
|   |  | | |





collant

prodotti

glueflex grigio

glueflex bianco

glueflex hp grigio

glueflex hp bianco

glueflex ultra grigio

glueflex ultra bianco

ti

glueflex grigio

scheda
tecnicadata
sheetficha
técnica

| adesivo cementizio grigio classe C2TE | interno esterno | cement-based grey adhesive, class C2TE | indoor outdoor | adhesivo cementoso gris clase C2TE | interior exterior |
|--|----------------------------|---|---------------------------|--|------------------------------|
| Adesivo cementizio grigio a prestazioni migliorate (C2) a scivolamento verticale nullo (T inferiore a 0,5mm). Tempo aperto allungato (E) per piastrelle in ceramica di medie dimensioni (300mm x 300 mm) e materiale lapideo. Per uso professionale. | | Improved-performance, cement-based grey adhesive (C2) with no vertical slip (T less than 0.5 mm). Extended open time (E) for medium-sized ceramic tiles (300 mm x 300 mm) and stone. For professional use. | | Adhesivo cementoso gris de prestaciones mejoradas (C2) con deslizamiento vertical nulo (T inferior a 0,5 mm). Tiempo abierto prolongado (E) para baldosas en cerámica de tamaño mediano (300 mm x 300 mm) y material lapideo. Para uso profesional. | |
| Granulometria: max 0,5 mm Attrezzatura: spatola dentata, cazzuola, impastatrice a basso numero di giri Rapporto di miscelazione: acqua - 26-28% Consumo: Mosaici piccoli formati 2 kg/m ² - standard 2,5-3,5 kg/m ² - grandi 4,5-5 kg/m ² Colore: grigio | | Particle size: max 0,5 mm Equipment: serrated spatula, trowel, low speed mixer Mixing Ratio: water - 26-28% Coverage: Small Mosaics 2 kg/m ² - Standard sizes 2.5-3.5 kg/m ² - Large formats 4.5-5 kg/m ² Color: grey | | Granulometría: max 0,5 mm Herramientas: espátula dentada, paleta, agitador mecánico de bajo número de revoluciones Proporción de mezcla: agua - 26-28% Consumo: Mosaicos de pequeño tamaño 2 kg/m ² - estándar 2,5-3,5 kg/m ² - grandes 4,5-5 kg/m ² Color: gris | |

| tecniche | certificazioni | proprietà | tecnologie |
|--|---|-----------|------------|
|  WATER BASED  TROWEL |  | | |

glueflex bianco

scheda
tecnicadata
sheetficha
técnica

| adesivo cementizio bianco classe C2TE | interno esterno | adesivo cementizio white classe C2TE | indoor outdoor | adhesivo cementoso blanco clase C2TE | interior exterior |
|--|----------------------------|--|---------------------------|--|------------------------------|
| Adesivo cementizio bianco a prestazioni migliorate (C2) a scivolamento verticale nullo (T inferiore a 0,5mm). Tempo aperto allungato (E) per piastrelle in ceramica di medie dimensioni (300mm x 300 mm) e materiale lapideo. Per uso professionale. | | Improved-performance, cement-based grey adhesive (C2) with no vertical slip (T less than 0.5 mm). Extended open time (E) for medium-sized ceramic tiles (300 mm x 300 mm) and stone. For professional use. | | Adhesivo cementoso blanco de prestaciones mejoradas (C2) con deslizamiento vertical nulo (T inferior a 0,5 mm). Tiempo abierto prolongado (E) para baldosas en cerámica de tamaño mediano (300 mm x 300 mm) y material lapideo. Para uso profesional. | |
| Granulometria: max 0,5 mm Attrezzatura: spatola dentata, cazzuola, impastatrice a basso numero di giri Rapporto di miscelazione: acqua - 27-29% Consumo: Mosaici piccoli formati 2 kg/m ² - standard 2,5-3,5 kg/m ² - grandi 4,5-5 kg/m ² Colore: bianco | | Particle size: max 0,5 mm Equipment: serrated spatula, trowel, low speed mixer Mixing Ratio: water - 27-29% Coverage: Small Mosaics 2 kg/m ² - Standard sizes 2.5-3.5 kg/m ² - Large formats 4.5-5 kg/m ² Color: white | | Granulometría: max 0,5 mm Herramientas: espátula dentada, paleta, agitador mecánico de bajo número de revoluciones Proporción de mezcla: agua - 27-29% Consumo: Mosaicos de pequeño tamaño 2 kg/m ² - estándar 2,5-3,5 kg/m ² - grandes 4,5-5 kg/m ² Color: blanco | |

| tecniche | certificazioni | proprietà | tecnologie |
|--|---|-----------|------------|
|  WATER BASED  TROWEL |  | | |

glueflex hp grigio



scheda
tecnica



data
sheet



ficha
técnica



| | | | | | |
|--|------------------------|---|-----------------------|--|--------------------------|
| adesivo cementizio grigio classe C2TE | interno esterno | cement-based grey adhesive, class C2TE | indoor outdoor | adhesivo cementoso gris clase C2TE | interior exterior |
| Adesivo cementizio grigio ad alte prestazioni (C2) a scivolamento verticale nullo (T inferiore a 0,5mm). Tempo aperto allungato (E) per piastrelle in ceramica e gres porcellanato di medie dimensioni (300mm x 300 mm) e materiale lapideo. Per uso professionale. | | High-performance (C2), cement-based adhesive grey with no vertical slip (t less 0.5 mm) with extended open time (E) for medium-sized ceramic tiles (300mmx300mm), porcelain stoneware and stone materials. For professional use. | | Adhesivo cementoso gris de altas prestaciones (C2) con deslizamiento vertical nulo (T inferior a 0,5 mm), tiempo abierto (E) ampliado para baldosas en cerámica (300mmx300mm), gres porcelánico de tamaño mediano y material lapideo. Para uso profesional. | |
| Granulometria: max 0,5 mm Attrezzatura: spatola dentata, cazzuola, impastatrice a basso numero di giri Rapporto di miscelazione: acqua - 26-28% Consumo: Mosaici piccoli formati 2 kg/m ² - standard 2,5-3,5 kg/m ² - grandi 4,5-5 kg/m ² Colore: grigio | | Particle size: max 0,5 mm Equipment: serrated spatula, trowel, low speed mixer Mixing Ratio: water - 26-28% Coverage: Small Mosaics 2 kg/m ² - Standard sizes 2.5-3.5 kg/m ² - Large formats 4.5-5 kg/m ² Color: grey | | Granulometría: max 0,5 mm Herramientas: espátula dentada, paleta, agitador mecánico de bajo número de revoluciones Proporción de mezcla: agua - 26-28% Consumo: Mosaicos de pequeño tamaño 2 kg/m ² - estándar 2,5-3,5 kg/m ² - grandes 4,5-5 kg/m ² Color: gris | |

| tecniche | | | certificazioni | proprietà | | | tecnologie | | |
|----------|--|--|----------------|-----------|--|--|------------|--|--|
| | | | | | | | | | |

glueflex hp bianco



scheda
tecnica



data
sheet



ficha
técnica



| | | | | | |
|--|------------------------|--|-----------------------|--|--------------------------|
| adesivo cementizio bianco classe C2TE | interno esterno | cement-based grey adhesive, class C2TE | indoor outdoor | adhesivo cementoso blanco clase C2TE | interior exterior |
| Adesivo cementizio bianco ad alte prestazioni (C2) a scivolamento verticale nullo (T inferiore a 0,5mm). Tempo aperto allungato (E) per piastrelle in ceramica e gres porcellanato di medie dimensioni (300mm x 300 mm) e materiale lapideo. Per uso professionale. | | High-performance (C2), cement-based adhesive grey with no vertical slip (t less 0.5 mm) with extended open time (E) for medium-sized ceramic tiles (300mmx300mm), porcelain stoneware and stone materials. For professional use. | | Adhesivo cementoso blanco de altas prestaciones (C2) con deslizamiento vertical nulo (T inferior a 0,5 mm), tiempo abierto (E) ampliado para baldosas en cerámica (300mmx300mm), gres porcelánico de tamaño mediano y material lapideo. Para uso profesional. | |
| Granulometria: max 0,5 mm Attrezzatura: spatola dentata, cazzuola, impastatrice a basso numero di giri Rapporto di miscelazione: acqua - 27-29% Consumo: Mosaici piccoli formati 2 kg/m ² - standard 2,5-3,5 kg/m ² - grandi 4,5-5 kg/m ² Colore: bianco | | Particle size: max 0,5 mm Equipment: serrated spatula, trowel, low speed mixer Mixing Ratio: water - 27-29% Coverage: Small Mosaics 2 kg/m ² - Standard sizes 2.5-3.5 kg/m ² - Large formats 4.5-5 kg/m ² Color: white | | Granulometría: max 0,5 mm Herramientas: espátula dentada, paleta, agitador mecánico de bajo número de revoluciones Proporción de mezcla: agua - 27-29% Consumo: Mosaicos de pequeño tamaño 2 kg/m ² - estándar 2,5-3,5 kg/m ² - grandes 4,5-5 kg/m ² Color: blanco | |

| tecniche | | | certificazioni | proprietà | | | tecnologie | | |
|----------|--|--|----------------|-----------|--|--|------------|--|--|
| | | | | | | | | | |

glueflex ultra grigio

scheda
tecnicadata
sheetficha
técnica

| adesivo cementizio grigio classe C2TE | interno esterno | flexible cement- based grey adhesive, class C2TE S1 | indoor outdoor | adhesivo cementoso gris flexible clase C2TE S1 | interior exterior |
|--|--------------------|---|-------------------|--|----------------------|
| Adesivo cementizio grigio flessibile (S1) ad alte prestazioni (C2) a scivolamento verticale nullo (T inferiore a 0,5mm). Tempo aperto allungato (E) per piastrelle in ceramica e gres porcellanato di medie dimensioni (300mm x 300 mm), materiale lapideo, cotto e Klinker. Idoneo per incollaggio di ceramica e gres anche in grande formato a pavimento standard e per pavimenti riscaldati. Per uso professionale. | | High-performance (C2), flexible (S1) cement-based grey adhesive with no vertical slip (T less than 0.5 mm). Extended open time (E) for medium-sized ceramic tiles and porcelain stoneware (300 mm x 300 mm), stone, terracotta, and klinker. Suitable for gluing ceramic and stoneware tiles, even in large sizes, to standard and heated floors. For professional use. | | Adhesivo cementoso gris flexible (S1) de altas prestaciones (C2) con deslizamiento vertical nulo (T inferior a 0,5 mm). Tiempo abierto prolongado (E) para baldosas en cerámica y gres porcelánico de tamaño mediano (300 mm x 300 mm), material lapideo, barro cocido y klinker. Idóneo para encolado de cerámica y gres, incluso en formatos grandes, a suelos estándares y para suelos radiantes. Para uso profesional. | |
| Granulometria: max 0,5 mm Attrezzatura: spatola dentata, cazzuola, impastatrice a basso numero di giri Rapporto di miscelazione: acqua - 29-31% Consumo: Mosaici piccoli formati 2 kg/m ² - standard 2,5-3,5 kg/m ² - grandi 4,5-5 kg/m ² Color: grigio | | Particle size: max 0,5 mm Equipment: serrated spatula, trowel, low speed mixer Mixing Ratio: water - 29-31% Coverage: Small Mosaics 2 kg/m ² - Standard sizes 2.5-3.5 kg/m ² - Large formats 4.5-5 kg/m ² Color: grey | | Granulometría: max 0,5 mm Herramientas: espátula dentada, paleta, agitador mecánico de bajo número de revoluciones Proporción de mezcla: agua - 29-31% Consumo: Mosaicos de pequeño tamaño 2 kg/m ² - estándar 2,5-3,5 kg/m ² - grandes 4,5-5 kg/m ² Color: gris | |

| tecniche | certificazioni | proprietà | tecnologie |
|--|---|-----------|------------|
|  WATER BASED  TROWEL |  | | |

glueflex ultra bianco

scheda
tecnicadata
sheetficha
técnica

| adesivo cementizio bianco classe C2TE | interno esterno | flexible cement- based white adhesive, class C2TE | indoor outdoor | adhesivo cementoso blanco flexible clase C2TE | interior exterior |
|--|--------------------|---|-------------------|--|----------------------|
| Adesivo cementizio bianco flessibile (S1) ad alte prestazioni (C2) a scivolamento verticale nullo (T inferiore a 0,5mm). Tempo aperto allungato (E) per piastrelle in ceramica e gres porcellanato di medie dimensioni (300mm x 300 mm), materiale lapideo, cotto e Klinker. Idoneo per incollaggio di ceramica e gres anche in grande formato a pavimento standard e per pavimenti riscaldati. Per uso professionale. | | High-performance (C2), flexible (S1) cement-based grey adhesive with no vertical slip (T less than 0.5 mm). Extended open time (E) for medium-sized ceramic tiles and porcelain stoneware (300 mm x 300 mm), stone, terracotta, and klinker. Suitable for gluing ceramic and stoneware tiles, even in large sizes, to standard and heated floors. For indoor and outdoor use. For professional use. | | Adhesivo cementoso blanco flexible (S1) de altas prestaciones (C2) con deslizamiento vertical nulo (T inferior a 0,5 mm). Tiempo abierto prolongado (E) para baldosas en cerámica y gres porcelánico de tamaño mediano (300 mm x 300 mm), material lapideo, barro cocido y klinker. Idóneo para encolado de cerámica y gres, incluso en formatos grandes, a suelos estándares y para suelos radiantes. Para uso profesional. | |
| Granulometria: max 0,5 mm Attrezzatura: spatola dentata, cazzuola, impastatrice a basso numero di giri Rapporto di miscelazione: acqua - 30-32% Consumo: Mosaici piccoli formati 2 kg/m ² - standard 2,5-3,5 kg/m ² - grandi 4,5-5 kg/m ² Color: bianco | | Particle size: max 0,5 mm Equipment: serrated spatula, trowel, low speed mixer Mixing Ratio: water - 30-32% Coverage: Small Mosaics 2 kg/m ² - Standard sizes 2.5-3.5 kg/m ² - Large formats 4.5-5 kg/m ² Color: white | | Granulometría: max 0,5 mm Herramientas: espátula dentada, paleta, agitador mecánico de bajo número de revoluciones Proporción de mezcla: agua - 30-32% Consumo: Mosaicos de pequeño tamaño 2 kg/m ² - estándar 2,5-3,5 kg/m ² - grandes 4,5-5 kg/m ² Color: blanco | |

| tecniche | certificazioni | proprietà | tecnologie |
|--|---|-----------|------------|
|  WATER BASED  TROWEL |  | | |





sigillan

prodotti

sigiltow fl

sigiltow universale

celertow

malta modellabile

nti

sigil tow fl

scheda
tecnicadata
sheetficha
técnica

| sigillante per fughe da 3 a 15 mm classe CG2 | interno esterno | sealant for joints from 3 to 15 mm, class CG2 | indoor outdoor | sellador para juntas de 3 a 15 mm clase CG2 | interior exterior |
|---|--------------------|--|-------------------|---|----------------------|
| Malta sigillante cementizia (C) per fughe (G) tra piastrelle migliorata (2) da 3 a 15 mm. Classe secondo norma europea EN 13888 CG2. Idoneo per stuccature di piastrelle ceramiche, gres, listelli klinker e cotto. Ideale come fugante per TermoK8 Modular D e Facciavista. Miscelato con acqua il prodotto diventa una malta di facile applicazione e pulizia. Per interni ed esterni. Per uso professionale. | | Improved cement sealing mortar (C) for joints (G) between tiles (2) from 3 to 15 mm. Classification as per European standard EN 13888 CG2. Suitable for plastering ceramic and stoneware tiles, clinker slips, and terracotta slips. Ideal as a grout for TermoK8 Modular D and Facciavista. When mixed with water, the product yields a mortar that is easy to apply and clean. For professional use. | | Mortero sellador de cemento (C) para juntas (G) entre baldosas mejorado (2) de 3 a 15 mm. Clase conforme a la norma europea EN 13888 CG2. Idóneo para emplastes de baldosas cerámicas, gres, listeles de clinker y barro cocido. Ideal como mortero de rejuntado para TermoK8 Modular D y Facciavista. Mezclado con agua, el producto es un mortero de fácil aplicación y limpieza. Para uso profesional. | |
| Granulometria: max 0,5 mm Attrezzatura: spatola, cazzuola, impastatrice a basso numero di giri Rapporto di miscelazione: acqua - 18-20% Consumo: in base alla dimensione delle piastrelle Colore: bianco 01, grigio cemento 30, grigio Manhattan 33, grigio silver 29, antracite 31 | | Particle size: max 0,5 mm Equipment: spatula, trowel, low speed mixer Mixing Ratio: water - 18-20% Coverage: according to tiles size Color: white 01, cement grey 30, Manhattan grey 33, silver grey 29, anthracite 31 | | Granulometría: max 0,5 mm Herramientas: espátula, paleta, agitador mecánico de bajo número de revoluciones Proporción de mezcla: agua - 18-20% Consumo: basado en el tamaño de las baldosas Color: blanco 01, gris cemento 30, gris Manhattan 33, gris silver 29, antracite 31 | |

| tecniche | certificazioni | proprietà | tecnologie |
|--|---|-----------|------------|
|  WATER BASED  TROWEL |  CE EN 13888 CG2 | | |

sigil tow universale

scheda
tecnicadata
sheetficha
técnica

| sigillante per fughe da 2 a 15 mm classe CG2 | interno esterno | sealant for joints from 2 to 15 mm, class CG2 | indoor outdoor | sellador para juntas de 2 a 15 mm clase CG2 | interior exterior |
|--|--------------------|---|-------------------|---|----------------------|
| Malta sigillante cementizia (C) per fughe (G) tra piastrelle migliorata (2) da 1 a 15 mm per fughe di pavimenti e rivestimenti ceramici di ogni tipo (monocottura, bicottura, clinker, gres porcellanato...) materiale lapideo, mosaico, vetro mattone e marmo. Miscelato con acqua il prodotto diventa una malta di facile applicazione e pulizia. Per uso professionale. | | Improved (2) cement-based sealing mortar (C) for joints (G) between tiles from 1 to 15 mm for joints between all types of tile flooring and covering (single-fired, double-fired, clinker, porcelain stoneware, etc.) stone, mosaics, glass, brick, and marble. When mixed with water, the product yields a mortar that is easy to apply and clean. For professional use. | | Mortero sellador de cemento (C) para juntas (G) entre baldosas mejorado (2) de 1 a 15 mm para juntas de suelos y revestimientos cerámicos de todo tipo (monococción, bicocción, clinker, gres porcelánico...) material lapideo, mosaico, ladrillos de vidrio y mármol. Mezclado con agua, el producto es un mortero de fácil aplicación y limpieza. Para uso profesional. | |
| Granulometria: max 0,3 mm Attrezzatura: spatola, cazzuola, impastatrice a basso numero di giri Rapporto di miscelazione: acqua - 25-27% Consumo: in base alla dimensione delle piastrelle Colore: bianco 01, grigio cemento 30, grigio perla 29, antracite 31 | | Particle size: max 0,3 mm Equipment: spatula, trowel, low speed mixer Mixing Ratio: water - 25-27% Coverage: according to tiles size Color: white 01, cement grey 30, pearl grey 29, anthracite 31 | | Granulometría: max 0,3 mm Herramientas: espátula, paleta, agitador mecánico de bajo número de revoluciones Proporción de mezcla: agua - 25-27% Consumo: basado en el tamaño de las baldosas Color: blanco 01, gris cemento 30, gris perla 29, antracite 31 | |

| tecniche | certificazioni | proprietà | tecnologie |
|--|---|-----------|------------|
|  WATER BASED  TROWEL |  CE EN 13888 CG2 | | |

celertow



scheda
tecnica



data
sheet



ficha
técnica



| | | | | | |
|---|------------------------|--|-----------------------|---|--------------------------|
| legante per fissaggi a presa rapida | interno esterno | binder for fast-setting fixings | indoor outdoor | aglutinante para fijaciones de fraguado rápido | interior exterior |
| Legante antiritiro in polvere a presa rapida a base di cemento inerte ed additivi. Idoneo per ripristini di piccole superfici verticali e soffittature, rinzaffi, piccole stuccature, e fissaggio di elementi nelle murature. Per interno e esterno. Per uso professionale. | | Fast setting, anti-shrinkage powder binder containing inert cement and additives. Suitable to repair small vertical walls and ceiling surfaces, rough coats, minor plastering and for securing masonry features. For professional use. | | Aglutinante anti-retracción en polvo de fraguado rápido a base de cemento inerte y aditivos. Idóneo para renovación de pequeñas superficies verticales y techos, repellados, pequeños emplastes y fijación de elementos en las paredes. Para uso profesional. | |
| Granulometria: max 0,6 mm Attrezzatura: spatola, cazzuola, impastatrice a basso numero di giri Rapporto di miscelazione: acqua - 22% Consumo: 1,5 kg per litro di cavità Colore: grigio | | Particle size: max 0,6 mm Equipment: spatula, trowel, low speed mixer Mixing Ratio: water - 22% Coverage: 1,5 kg per litre of cavity Color: grey | | Granulometría: max 0,6 mm Herramientas: espátula, paleta, agitador mecánico de bajo número de revoluciones Proporción de mezcla: agua - 22% Consumo: 1,5 kg por litro de cavidad Color: gris | |

| tecniche | | certificazioni | | proprietà | | tecnologie | |
|----------|--|----------------|--|-----------|--|------------|--|
| | | | | | | | |

malta modellabile



scheda
tecnica



data
sheet



ficha
técnica



| | | | | | |
|---|------------------------|---|-----------------------|---|--------------------------|
| malta fibrata tixotropica da ricostruzione base calce | interno esterno | lime-based fibre-reinforced thixotropic mortar for reconstruction | indoor outdoor | mortero fibrado tixotrópico de reconstrucción a base de cal | interior exterior |
| Malta preconfezionata fibrata a base di Calce Idraulica Naturale, a presa rapida e basso modulo elastico. Consente la perfetta ricostruzione di cornicioni, modanature, capitelli e fregi essendo immediatamente modellabile e sagomabile. Altamente tixotropica e antiritiro. Particolarmente idonea per gli interventi di ripristino in edifici storici monumentali. Per uso professionale. | | Fast setting, low elastic modulus pre-mixed fibre-reinforced mortar. Can be promptly moulded and shaped, allowing perfect reconstruction of cornices, mouldings, capitals and friezes. Highly thixotropic and anti-shrinkage. Particularly suited for repairs to historic buildings and monuments. For professional use | | Mortero preenvasado fibrado de fraguado rápido y módulo elástico bajo. Permite la perfecta reconstrucción de cornisas, molduras, capiteles y frisos, ya que admite modelado y perfilado directo. Altamente tixotrópica y anti-retracción. Particularmente adecuada para las actuaciones de renovación de edificios históricos monumentales. Para uso profesional. | |
| Granulometria: max 1,2 mm Attrezzatura: spatola, cazzuola, impastatrice a basso numero di giri Rapporto di miscelazione: acqua - 22% Consumo: 16 kg/m ² per cm di spessore Colore: nocciola | | Particle size: max 1,2 mm Equipment: spatula, trowel, low speed mixer Mixing Ratio: water - 22% Coverage: 16 kg/m ² per mm of thickness Color: hazelnut | | Granulometría: max 1,2 mm Herramientas: espátula, paleta, agitador mecánico de bajo número de revoluciones Proporción de mezcla: agua - 22% Consumo: 16 kg/m ² per cm de espesor Color: avellanado | |

| tecniche | | certificazioni | | proprietà | | tecnologie | |
|----------|--|----------------|--|-----------|--|------------|--|
| | | | | | | | |



deumid

prodotti

towsan primer

towsan

towsan light

towsan finitura

tow-rin



ificanti

towsan primer

scheda
tecnicadata
sheetficha
técnica

| | | | | | |
|--|----------------------------|---|---------------------------|--|------------------------------|
| impregnante antisale per murature umide | interno esterno | anti-salt impregnating agent for damp masonry | indoor outdoor | impregnante antisal para paredes húmedas | interior exterior |
| Impregnante costituito da una miscela di silicati e derivati silicologici opportunamente modificati e stabilizzati. Idoneo per il bloccaggio delle efflorescenze saline su murature umide. Da utilizzarsi previamente prima di applicare intonaco Towsan. Per uso professionale. | | Impregnating agent consisting of a mixture of silicates and silicone derivatives suitably modified and stabilised. Ideal to block efflorescence and defend against capillary rising damp. To be used in advance before applying Towsan plaster. For professional use. | | Impregnante constituido por una mezcla de silicatos y derivados silicológicos convenientemente modificados y estabilizados. Perfecto para bloquear las efflorescencias y contener la extensión del agua. Utilizar previamente antes de aplicar el yeso Towsan. Para uso profesional. | |
| Attrezzatura: pennello Rapporto di miscelazione: acqua - 100% Resa: 6-8 m ² /l Colore: bianco | | Equipment: brush Mixing Ratio: water - 100% Coverage: 6-8 m ² /l Color: white | | Herramientas: brocha Proporción de mezcla: agua - 100% Rendimiento: 6-8 m ² /l Color: blanco | |

| tecniche | certificazioni | proprietà | tecnologie |
|-----------------|----------------|-----------|------------|
| WATER BASED | | | |
| BRUSH | | | |

towsan

scheda
tecnicadata
sheetficha
técnica

| | | | | | |
|--|----------------------------|---|---------------------------|---|------------------------------|
| intonaco deumidificante | interno esterno | dehumidifying plaster | indoor outdoor | enfoscado deshumidificante | interior exterior |
| Intonaco deumidificante per ripristini verticali idoneo al risanamento di murature umide. Premiscelato a base di cementi e sabbie selezionate industriali ed additivi specifici (aeranti, compensatore di ritiri, reazione pozzolanica per migliorare la resistenza ai solfati). Necessaria applicazione previa di Towsan Primer. Per uso professionale. | | Dehumidifying plaster for vertical repairs, suited for restoring damp masonry. Premix based on selected industrial cements and sands and specific additives (aerators, shrinkage compensator, pozzolanic reaction to improve resistance to sulphates). Easy to work. The layers applied adhere well, are durable and show no shrinkage. Necessary prior application of Towsan Primer. For professional use. | | Enfoscado deshumidificante para renovaciones verticales, adecuado para saneamiento de paredes con humedad. Premezclado a base de cementos y arenas seleccionadas industriales y aditivos específicos (aireantes, compensador de retracción, reacción pozzolánica para mejorar la resistencia a los sulfatos). Aplicación previa necesaria de Towsan Primer. Para uso profesional. | |
| Granulometria: max 1,2 mm Attrezzatura: spatola, cazzuola, betoniera Rapporto di miscelazione: acqua - 20% Consumo: 28 kg/m ² per 2 cm di spessore Colore: grigio | | Particle size: max 1,2 mm Equipment: spatula, trowel, cement mixer Mixing Ratio: water - 20% Coverage: 28 kg/m ² per 2 mm of thickness Color: grey | | Granulometría: max 1,2 mm Herramientas: espátula, paleta, hormigonera Proporción de mezcla: agua - 20% Consumo: 28 kg/m ² per 2 cm de espesor Color: gris | |

| tecniche | certificazioni | proprietà | tecnologie |
|-----------------|------------------------|-----------|------------|
| WATER BASED | | | |
| TROWEL | EN 998-1 RCS II | | |

towsan light

scheda
tecnicadata
sheetficha
técnica

| | | | | | |
|---|----------------------------|--|---------------------------|---|------------------------------|
| intonaco deumidificante alleggerito | interno esterno | lightweight dehumidifying plaster | indoor outdoor | enfoscado deshumidificante aligerado | interior exterior |
| Malta da intonaco deumidificante alleggerita per ripristini verticali idoneo al risanamento di murature umide. Premiscelato a base di cementi inerti leggeri, sabbie selezionate industriali ed additivi specifici. Intonaco perfettamente lavorabile i cui strati applicati risultano ben aderenti, durevoli e privi di ritiro. Non necessita di primer antisale. Per uso professionale. | | Dehumidifying lightweight mortar to repair vertical walls. Suitable for restoring damp masonry. Premix based on light inert cements, selected industrial sands and specific additives. No need for an anti-salt primer. The layers applied adhere well, are durable and show no shrinkage. For professional use. | | Mortero deshumidificante aligerado para renovaciones verticales, idóneo para el saneamiento de paredes con humedad. Premezclado a base de cementos áridos ligeros y arenas seleccionadas industriales y aditivos específicos. Enfoscado perfectamente elaborable cuyas capas aplicadas ofrecen un resultado bien adherente, duradero y sin retracción. Sin necesidad de imprimación anti-sal. Para uso profesional. | |
| Granulometria: max 1,2 mm Attrezzatura: spatola, cazzuola, betoniera Rapporto di miscelazione: acqua - 18% Consumo: 20 kg/m ² per 2 cm di spessore Colore: grigio | | Particle size: max 1,2 mm Equipment: spatula, trowel, cement mixer Mixing Ratio: water - 18% Coverage: 20 kg/m ² per 2 mm of thickness Color: grey | | Granulometría: max 1,2 mm Herramientas: espátula, paleta, hormigonera Proporción de mezcla: agua - 18% Consumo: 20 kg/m ² per 2 cm de espesor Color: gris | |

| tecniche | certificazioni | proprietà | tecnologie |
|-----------------|------------------------|-----------|------------|
| WATER BASED | | | |
| TROWEL | EN 998-1 RCS II | | |

towsan finitura

scheda
tecnicadata
sheetficha
técnica

| rasante minerale bianco traspirante - 0,4 mm | interno esterno | breathable white mineral skim coat - 0.4 mm | indoor outdoor | mortero de enrasado mineral blanco transpirante- 0,4 mm | interior exterior |
|---|-----------------|--|----------------|---|-------------------|
| Rasante minerale bianco grana 0,4. L'ottima traspirabilità lo rende idoneo per la rasatura a civile fine di Towsan e Towsan Light. A base di inerti selezionati, leganti aerei, idraulici ed additivi specifici. Dotato di ottima spatolabilità e riempimento, estremamente versatile per la facilità d'uso. Per uso professionale. | | White mineral skim coat, with 0.4mm grain size. Its excellent breathability makes it suitable for fine two-coat skimming of Towsan and Towsan Light. Based on selected inert materials, hydraulic and air binders, and specific additives. With superb spreadability and filling capacity, it is extremely versatile due to its ease of use. For professional use. | | Mortero de enrasado mineral blanco grano 0,4. La excelente transpirabilidad lo hace idóneo para el enrasado de revoco fino de Towsan y Towsan Light. A base de áridos seleccionados, aglutinantes aéreos e hidráulicos y aditivos específicos. Excelente facilidad para su extensión con espátula y relleno, extremadamente versátil por su facilidad de uso. Para uso profesional. | |
| Granulometria: max 0,4 mm Attrezzatura: spatola, cazzuola, frattazzo, impastatrice a basso numero di giri Rapporto di miscelazione: acqua - 20-22% Consumo: 1,4 kg/m ² per mm di spessore Colore: bianco | | Particle size: max 0,4 mm Equipment: spatula, trowel, trowel, low speed mixer Mixing Ratio: water - 20-22% Coverage: 1,4 kg/m ² per mm of thickness Color: white | | Granulometría: max 0,4 mm Herramientas: espátula, paleta, frattazzo, agitador mecánico de bajo número de revoluciones Proporción de mezcla: agua - 20-22% Consumo: 1,4 kg/m ² per mm de espesor Color: blanco | |

| tecniche | certificazioni | proprietà | tecnologie |
|--|---|-----------|------------|
|  WATER BASED  TROWEL |  | | |

tow-rin

scheda
tecnicadata
sheetficha
técnica

| intonaco minerale da ripristino e rinzaffo - 3 mm | interno esterno | mineral plaster for repairs and rough coats - 3 mm | indoor outdoor | mortero de enfoscado mineral de renovación y repellido - 3 mm | interior exterior |
|---|-----------------|---|----------------|--|-------------------|
| Malta da intonaco per ripristino di Intonaci esistenti fino a 30 mm e rinzaffo minerale per le riprese localizzate. Composto premiscelato costituito da leganti idraulici, inerti selezionati, additivi specifici e fibre. Tow-Rin è una malta additivata per promuovere l'adesione di intonaci calce - cemento su vecchie murature non omogenee. Idoneo per applicazione meccanica e manuale. Per uso professionale. | | Plaster mortar for repairing existing plaster up to 30 mm and mineral rough coats for localised repairs. This product is a premix composed of hydraulic binders, selected inert materials, specific additives, and fibres. Tow-Rin contains additives that improve adhesion of lime- and cement-based plaster on old, uneven walls. Suitable for mechanical and manual application. For professional use. | | Mortero de enfoscado para renovación de enfoscados ya existentes de hasta 30 mm y repellido mineral para puntos localizados. Compuesto premezclado constituido por aglutinantes hidráulicos, áridos seleccionados, aditivos específicos y fibras. Tow-Rin es un mortero con aditivos para activar la adhesión de enfoscados de cal - cemento sobre paredes viejas no homogéneas. Idóneo para aplicación mecánica y manual. Para uso profesional. | |
| Granulometria: max 3 mm Attrezzatura: spatola, cazzuola, intonacatrice meccanica Rapporto di miscelazione: acqua - 20-22% Consumo: 15 kg/m ² per cm di spessore Colore: grigio | | Particle size: max 3 mm Equipment: spatula, trowel, mechanical plastering machine Mixing Ratio: water - 20-22% Coverage: 15 kg/m ² per mm of thickness Color: grey | | Granulometría: max 3 mm Herramientas: espátula, paleta, enfoscadora mecánica Proporción de mezcla: agua - 20-22% Consumo: 15 kg/m ² per cm de espesor Color: gris | |

| tecniche | certificazioni | proprietà | tecnologie |
|--|---|-----------|------------|
|  WATER BASED  TROWEL  PLASTERING MACHINE |  | | |



massetti

tow level



scheda
tecnica



data
sheet



ficha
técnica



| | | | | | |
|---|----------------------------|--|---------------------------|---|------------------------------|
| autolivellante cementizio spessore massimo 3-10 mm | interno esterno | cement-based, self-levelling, max thickness 3-10 mm | indoor outdoor | autonivelante de cemento de espesor máximo 3-10 mm | interior exterior |
| <p>Malta autolivellante per pavimenti ad asciugatura rapida. Idonea per livellare ed eliminare differenze di spessore da 3 a 10 mm di sottofondi nuovi o preesistenti creando un piano perfettamente planare e uniforme adatto a ricevere ogni tipo di pavimento. Dotato di elevate resistenze meccaniche e ottimo potere di adesione, offre un'ottima resistenza al traffico e al carico. Per uso professionale.</p> | | <p>Self-levelling and quick-drying mortar for indoor floors. Suitable for levelling and getting rid of thickness differences from 3 to 10 mm of new or existing substrates, it creates a perfectly level and uniform surface for receiving all types of flooring. As it has high mechanical resistance and an outstanding adhesion power, it offers excellent traffic and load resistance. For professional use.</p> | | <p>Mortero autonivelante para suelos, de secado rápido. Idóneo para nivelar y eliminar diferencias de espesor de 3 a 10 mm de substratos nuevos o preexistentes, creando una superficie perfectamente plana y uniforme, adecuada para recibir todo tipo de suelos. Dotado de altas resistencias mecánicas y excelente poder adhesivo, ofrece una excelente resistencia al tráfico y a la carga. Para uso profesional.</p> | |
| <p>Granulometria: max 0,6 mm Attrezzatura: impastatrice a basso numero di giri, spatola, racla di gomma, rullo frangibolle Rapporto di miscelazione: acqua - 24-25% Consumo: 1,6 kg/m² per cm di spessore Colore: grigio</p> | | <p>Particle size: max 0,6 mm Equipment: low speed mixer, spatula, rubber squeegee, bubble-buster roller Mixing Ratio: water - 24-25% Coverage: 1,6 kg/m² per mm of thickness Color: grey</p> | | <p>Granulometría: max 0,6 mm Herramientas: agitador mecánico de bajo número de revoluciones, espátula, rasqueta de goma, rodillo antiburbujas Proporción de mezcla: agua - 24-25% Consumo: 1,6 kg/m² per cm de espesor Color: gris</p> | |

| tecniche | | | certificazioni | proprietà | | | | tecnologie | | | |
|----------|--|--|----------------|-----------|--|--|--|------------|--|--|--|
| | | | | | | | | | | | |



impermea

prodotti

towflex

towflex ap

monoflex

towseal

towpruf



stabilizzanti

towflex

scheda
tecnicadata
sheetficha
técnica

| rasante impermeabilizzante elastico bicomponente | interno esterno | two-pack elastic waterproofing skim coat | indoor outdoor | mortero de enrasado impermeabilizante elástico bicomponente | interior exterior |
|---|-----------------|---|----------------|--|-------------------|
| Malta cementizia bicomponente elastica per l'impermeabilizzazione in spinta positiva di superfici in calcestruzzo, balconi, terrazze, bagni e piscine. Composta da un miscela di aggregati silicei, cemento, fibre parte A e da emulsione di resine elastiche parte B. La miscela dei componenti è stata studiata per avere una perfetta lavorabilità ed un'altissima adesione ai vari supporti. Spessore massimo applicabile 3 mm in due mani con opzione di rete di armatura Armatex C1. Per uso professionale. | | Two-pack elastic cement-based mortar to waterproof and protect concrete surfaces, balconies, terraces, baths and swimming pools. Towflex is a mixture of silica aggregates, cement and fibres in part A and an emulsion of elastic resins in part B. This formula has been designed to ensure perfect workability and excellent adhesion to various substrates. Maximum applicable thickness 3 mm in two coats with Armatex C1 reinforcement mesh option. For professional use. | | Mortero de cemento bicomponente elástico para la impermeabilización y protección de superficies de hormigón, balcones, terrazas, baños y piscinas. Towflex está formado por una mezcla de agregados silíceos, cemento y fibras (parte A) y emulsión de resinas elásticas (parte B). La mezcla de los componentes ha sido estudiada para que permita una perfecta facilidad de elaboración y un altísimo grado de adhesión a los distintos soportes. Espesor máximo aplicable 3 mm en dos manos con opción de malla de refuerzo Armatex C1. Para uso profesional. | |
| Granulometria: max 0,5 mm Attrezzatura: spatola dentata, impastatrice a basso numero di giri Rapporto di miscelazione: acqua - 33% Consumo: 1,8 kg/m ² per mm di spessore Colore: grigio | | Particle size: max 0,5 mm Equipment: serrated spatula, low speed mixer Mixing Ratio: water - 33% Coverage: 1,8 kg/m ² per mm of thickness Color: grey | | Granulometría: max 0,5 mm Herramientas: espátula dentada, agitador mecánico de bajo número de revoluciones Proporción de mezcla: agua - 33% Consumo: 1,8 kg/m ² per mm de espesor Color: gris | |

| tecniche | certificazioni | proprietà | tecnologie |
|-----------------|----------------|---------------------------|------------|
| WATER BASED | TROWEL | EN 1504-2 PM-IC-IR | |

towflex ap

scheda
tecnicadata
sheetficha
técnica

| rasante impermeabilizzante per contatto con acqua potabile | interno esterno | waterproofing skim coat for contact with drinking water | indoor outdoor | mortero de enrasado impermeabilizante para contacto con agua potable | interior exterior |
|---|-----------------|--|----------------|---|-------------------|
| Malta cementizia rasante impermeabilizzante elastico bicomponente per contatto con acqua potabile. Idoneo per l'impermeabilizzazione di vasche per il contenimento di acque ad uso potabile secondo il DM 21/03/1973 e successive modifiche come da certificato n° 141921 dell'Istituto Giordano. Può essere inoltre usato per impermeabilizzare sottofondi prima della posa della pavimentazione. Per uso professionale. | | Two-pack, elastic waterproofing cement-based skimming mortar for contact with drinking water. Suitable for waterproofing tanks used to hold drinking water in compliance with Italian Ministerial Decree dated 21/03/1973 and subsequent amendments thereto as per certificate no. 141921 issued by Istituto Giordano. It can also be used to waterproof floor substrates before paving. For professional use. | | Mortero de cemento para enrasado impermeabilizante elástico bicomponente para contacto con agua potable. Idóneo para la impermeabilización de estanques contenedores de agua potable según el DM 21/03/1973 y posteriores modificaciones, conforme al certificado n.º 141921 del Instituto Giordano. Puede usarse también para impermeabilizar sustratos antes de la colocación del piso. Para uso profesional. | |
| Granulometria: max 0,5 mm Attrezzatura: spatola dentata, impastatrice a basso numero di giri Rapporto di miscelazione: Il componente A va miscelato solo con il componente B; 9 litri di componente B con 25 kg di componente A Consumo: 1,75 kg/m ² per mm di spessore Colore: grigio | | Particle size: max 0,5 mm Equipment: serrated spatula, low speed mixer Mixing Ratio: Pack A should only be mixed with pack B; 9 litres of pack B with 25 kg of pack A Coverage: 1,75 kg/m ² per mm of thickness Color: grey | | Granulometría: max 0,5 mm Herramientas: espátula dentada, agitador mecánico de bajo número de revoluciones Proporción de mezcla: el componente A debe mezclarse solo con el componente B; 9 litri de componente B con 25 kg de componente A Consumo: 1,75 kg/m ² per mm de espesor Color: gris | |

| tecniche | certificazioni | proprietà | tecnologie |
|-----------------|----------------|---------------------------|------------|
| WATER BASED | TROWEL | EN 1504-2 PM-IC-IR | |

monoflex



scheda
tecnica



data
sheet



ficha
técnica



| | | | | | |
|---|------------------------|---|-----------------------|---|--------------------------|
| malta cementizia monocomponente elastica | interno esterno | one-pack, elastic cement-based mortar. | indoor outdoor | mortero de cemento monocomponente elástico | interior exterior |
| Malta cementizia monocomponente elastica impermeabilizzante a spinta positiva. Consente di risolvere il problema dei supporti fessurati in maniera definitiva, idoneo per l'impermeabilizzazione di vasche per il contenimento di acque o sottofondi sia esterni che interni, prima della posa della pavimentazione. Ideale per la protezione del cemento armato da CO ₂ , SO ₂ , cloruri e solfati. Applicabile in bassi spessori anche a pennello. Per uso professionale. | | One-pack, elastic, positive-thrust waterproofing, cement-based mortar. This product permanently addresses surface cracks, and is suitable for waterproofing water holding tanks or substrates, both indoors and outdoors, before paving. Ideal for protecting reinforced concrete from CO ₂ , SO ₂ , chlorides, and sulphates. Can be applied in thin coats, even with a brush. For professional use. | | Mortero de cemento monocomponente elástico impermeabilizante de empuje positivo. Permite resolver el problema de los soportes con fisuras de forma definitiva, idóneo para la impermeabilización de estanques para la contención de agua o para sustratos tanto externos como internos, antes de la colocación del suelo. Ideal para la protección del hormigón armado contra CO ₂ , SO ₂ , cloruros y sulfatos. Aplicable en espesores bajos también con brocha. Para uso profesional. | |
| Granulometria: max 0,5 mm Attrezzatura: spatola, cazzuola, impastatrice a basso numero di giri Rapporto di miscelazione: acqua - 24% Consumo: 1,2 kg/m ² per mm di spessore Colore: grigio | | Particle size: max 0,5 mm Equipment: spatula, trowel, low speed mixer Mixing Ratio: water - 24% Coverage: 1,2 kg/m ² per mm of thickness Color: grey | | Granulometría: max 0,5 mm Herramientas: espátula, paleta, agitador mecánico de bajo número de revoluciones Proporción de mezcla: agua - 24% Consumo: 1,2 kg/m ² per mm de espesor Color: gris | |

| tecniche | | certificazioni | | proprietà | | | | tecnologie | | | |
|----------|--|----------------|--|-----------|--|--|--|------------|--|--|--|
| | | | | | | | | | | | |

towerseal



scheda
tecnica



data
sheet



ficha
técnica



| | | | | | |
|---|------------------------|---|-----------------------|---|--------------------------|
| boiaccia impermeabilizzante osmotica a basso spessore | interno esterno | low thickness osmotic waterproofing groutsore | indoor outdoor | lechada impermeabilizante osmótica de bajo espesor | interior exterior |
| Impermeabilizzante osmotico a base di cementi, inerti selezionati e additivi specifici, per il contenimento delle acque sia in spinta positiva che negativa. Idoneo per impermeabilizzare a basso spessore supporti in CLS quali vani ascensore, piscine e cantine. Applicazione prima mano a spatola in acciaio liscia e mani successive incrociate a pennello. Per uso professionale. | | Osmotic waterproofing product based on cements, selected inert materials and specific additives, for water containment in the case of both positive and negative thrust. Suitable for waterproofing low-thickness concrete substrates such as lift shafts, swimming pools, and cellars. First coat applied with a smooth steel spatula and subsequent cross coats by brush. For professional use. | | Impermeabilizante osmótico a base de cementos, áridos seleccionados y aditivos específicos, para contención de aguas tanto de empuje positivo como negativo. Idóneo para impermeabilizar con espesores bajos soportes de hormigón como huecos de ascensor, piscinas y sótanos. Aplicación de primera mano con espátula en acero lisa y manos sucesivas en pasadas de brocha cruzadas. Para uso profesional. | |
| Granulometria: max 0,4 mm Attrezzatura: spatola, cazzuola, intonacatrice meccanica Rapporto di miscelazione: acqua - 24-26% Consumo: 1,7 kg/m ² per mm di spessore Colore: grigio | | Particle size: max 0,4 mm Equipment: spatula, trowel, mechanical plastering machine Mixing Ratio: water - 24-26% Coverage: 1,7 kg/m ² per mm of thickness Color: grey | | Granulometría: max 0,4 mm Herramientas: espátula, paleta, enfoscadora mecánica Proporción de mezcla: agua - 24-26% Consumo: 1,7 kg/m ² per mm de espesor Color: gris | |

| tecniche | | certificazioni | | proprietà | | | | tecnologie | | | |
|----------|--|----------------|--|-----------|--|--|--|------------|--|--|--|
| | | | | | | | | | | | |

towpruf

scheda
tecnicadata
sheetficha
técnica

| intonaco impermeabilizzante osmotico | interno esterno | osmotic waterproofing plaster | indoor outdoor | mortero de enfoscado impermeabilizante osmótico | interior exterior |
|--|-----------------|---|----------------|---|-------------------|
| Malta da intonaco osmotica antiritiro a granulometria massima di 1,2 mm, idonea per impermeabilizzazione in verticale sia in spinta positiva che negativa di locali interrati, box, fosse d'ascensore e strutture atte al contenimento di acque, quali condotte, canalizzazioni, piscine e serbatoi. Miscela cementizia pronta all'uso, perfettamente lavorabile, ad altissima adesione su strutture in calcestruzzo. Applicabile a mano o con macchine bi-stadio (no intonacatrici in continuo). Per uso professionale. | | Anti-shrinkage osmotic plaster mortar with maximum particle size of 1.2 mm, suitable for vertical waterproofing – for both positive and negative thrust – of underground rooms, garages, lift shafts, and structures designed to contain water, such as pipelines, ducts, swimming pools and tanks. Ready-to-use, perfectly workable cement-based mixture with very high adhesion on concrete structures. Can be applied by hand or with two-stage machines (not continuous plastering machines). For professional use. | | Mortero de enfoscado osmótico anti-retracción con granulometría máxima de 1,2 mm, idóneo para impermeabilizar en vertical tanto en empuje positivo como negativo locales subterráneos, trasteros, huecos de ascensor y estructuras para la contención de aguas, como conductos, canalizaciones, piscinas y depósitos. Mezcla de cemento lista para usar, perfectamente elaborable, de altísimo poder adhesivo sobre estructuras de hormigón. Aplicable a mano o con máquinas de dos etapas (no enfoscadoras continuas). Para uso profesional. | |
| Granulometria: max 1,2 mm Attrezzatura: spatola, cazzuola, frattazzo di spugna, impastatrice a basso numero di giri Rapporto di miscelazione: acqua - 18% Consumo: 16 kg/m ² per cm di spessore Colore: grigio | | Particle size: max 1,2 mm Equipment: spatula, trowel, mason's trowel, low speed mixer Mixing Ratio: water - 18% Coverage: 16 kg/m ² per mm of thickness Color: grey | | Granulometría: max 1,2 mm Herramientas: espátula, paleta, frattazzo di spugna, agitador mecánico de bajo número de revoluciones Proporción de mezcla: agua - 18% Consumo: 16 kg/m ² per cm de espesor Color: gris | |

| tecniche | | certificazioni | proprietà | | | | tecnologie | | | |
|--|---|---|-----------|--|--|--|------------|--|--|--|
|  |  |  | | | | | | | | |





additivi e leganti

resintow



scheda
tecnica



data
sheet



ficha
técnica



| additivo liquido elasticizzante per malte | interno esterno | elasticising liquid additive for mortars. | indoor outdoor | aditivo líquido elastizante para morteros | interior exterior |
|---|-----------------|--|----------------|--|-------------------|
| <p>Additivo liquido per migliorare l'elasticità e l'adesione di malte e miscele cementizie. Adesivante liquido a base di resine elastomeriche fortemente resistenti agli alcali e non riemulsionabili in acqua. Tale emulsione forma un film che lega il cemento e la sabbia ed aumenta l'elasticità della malta incrementandone l'aderenza ai supporti e la resistenza meccanica all'usura. Per uso professionale.</p> | | <p>Liquid additive to improve adhesion of cement mortars and mixtures. Liquid adhesive containing elastomeric resins, which are highly resistant to alkalis and cannot be re-emulsified in water. This emulsion forms a film that binds cement and sand and increases the elasticity of the mortar, increasing adherence to the substrate and mechanical resistance to wear. For professional use.</p> | | <p>Aditivo líquido para mejorar la adhesión de morteros y mezclas de cemento. Adesivo líquido a base de resinas elastoméricas muy resistentes a los álcalis y no reemulsionables en agua. Dicha emulsión forma una película que une el cemento y la arena y aumenta la elasticidad del mortero, aumentando su adherencia a los soportes y la resistencia mecánica al desgaste. Para uso profesional.</p> | |
| <p>Attrezzatura: betoniera, impastatrice a basso numero di giri Diluizione: acqua - 400% Resa: vedi scheda prodotto in cui è stato additivato Colore: bianco</p> | | <p>Equipment: cement mixer, low speed mixer Dilution: water - 400% Coverage: See the data sheet for the product it has been added to Color: white</p> | | <p>Herramientas: hormigonera, agitador mecánico de bajo número de revoluciones Dilución: agua - 400% Rendimiento: vedi scheda prodotto in cui è stato additivato Color: blanco</p> | |

primer ra



scheda
tecnica



data
sheet



ficha
técnica



| promotore di adesione su superfici non assorbenti | interno esterno | adhesion promoter on poorly absorbent substrates | indoor outdoor | promotor de adhesión sobre fondos poco absorbentes | interior exterior |
|--|-----------------|---|----------------|---|-------------------|
| <p>Primer quarzifero di colore giallo semitrasparente idoneo come promotore di adesione ad effetto ruvido. A base di resine acriliche in emulsione ed inerti silicei e farine di quarzo. Appositamente studiato per favorire l'adesione di intonaci o rasanti cementizi su fondi lisci o poco assorbenti. Per uso professionale.</p> | | <p>Semi-transparent yellow adhesion promoter primer with a rough effect. It contains acrylic resins in emulsion and silica inert materials of such particle size as to produce a rough surface. Specially designed to facilitate adhesion of plaster or cement-based skim coats on smooth or poorly absorbent substrates. For professional use.</p> | | <p>Imprimación activadora de adhesión amarilla semitrasparente de efecto rugoso. A base de resinas acrílicas en emulsión y áridos silíceos, de granulometría adecuada para obtener una superficie rugosa. Expresamente estudiado para favorecer la adhesión de enfoscados o morteros de enrasado sobre fondos lisos o poco absorbentes. Para uso profesional.</p> | |
| <p>Attrezzatura: pennello, rullo a pelo corto Diluizione: acqua - 50% Resa (1 mano): 5-6 m²/l - Per confezione (14 l): 84 m² Colore: giallo</p> | | <p>Equipment: brush, roller Dilution: water - 50% Coverage (1 coat): 5-6 m²/l - Per package (14 l): 84 m² Color: yellow</p> | | <p>Herramientas: brocha, rodillo a pelo corto Dilución: agua - 50% Rendimiento (1 capa): 5-6 m²/l - Per envase (14 l): 84 m² Color: amarillo</p> | |

primer tack



scheda
tecnica



data
sheet



ficha
técnica



| promotore di adesione su superfici smaltate e legno | interno esterno | adhesion promoter on enamelled surfaces and wood | indoor outdoor | promotor de adhesión sobre superficies esmaltadas y de madera | interior exterior |
|---|-----------------|---|----------------|---|-------------------|
| <p>Primer gelatinoso monocomponente di colore azzurro semitrasparente atto ad aumentare l'adesione su sottofondi smaltati e pannelli in legn. A base di copolimeri acrilici in dispersione acquosa a bassa TMF (temperatura minima di filmazione). Per uso professionale.</p> | | <p>Light blue, semi-transparent, one-pack gelatinous primer designed to increase adhesion on enamelled substrates and wood panels. Based on acrylic copolymers in an aqueous dispersion with low MFFT (minimum film forming temperature). For professional use.</p> | | <p>Imprimación gelatinosa monocomponente de color celeste semitrasparente idónea para aumentar la adhesión sobre substratos esmaltados y paneles de madera. A base de copolímeros acrílicos en dispersión acuosa de baja TMF (temperatura mínima de formación de película). Para uso profesional.</p> | |
| <p>Attrezzatura: rullo di spugna Diluizione: pronto uso Resa (1 mano): 150-200 g/m² - Per confezione (5 kg): 33 m² Colore: azzurro</p> | | <p>Equipment: sponge roller Dilution: ready to use Coverage (1 coat): 150-200 g/m² - Per package (5 kg): 33 m² Color: light blue</p> | | <p>Herramientas: rodillo de spugna Dilución: listo para usar Rendimiento (1 capa): 150-200 g/m² - Por envase (5 kg): 33 m² Color: azul</p> | |



complementi

angolare esterno



Complemento in tessuto poliestere gommato per l'impermeabilizzazione di giunti e spigoli e/o zone di raccordo tra il piano orizzontale e verticale.

Dimensione: 14 cm
Angolo: 270°

Rubberised polyester fabric articles for waterproofing corner joints and/or joints between vertical and horizontal planes.

Dimension: 14 cm
Angle: 270°

Complementos en tejido de poliéster engomado para impermeabilizar juntas de esquina y / o áreas de conexión entre el plano vertical y horizontal

Dimensión: 14 cm
Angolo: 270°

angolare interno



Complemento in tessuto poliestere gommato per l'impermeabilizzazione di giunti e spigoli e/o zone di raccordo tra il piano orizzontale e verticale.

Dimensione: 14 cm
Angolo: 90°

Rubberised polyester fabric articles for waterproofing corners and/or joints between vertical and horizontal planes.

Dimension: 14 cm
Angle: 90°

Complementos en tejido de poliéster engomado para impermeabilizar juntas de esquina y / o áreas de conexión entre el plano vertical y horizontal

Dimensión: 14 cm
Angolo: 90°

banda



Complemento in tessuto poliestere gommato per l'impermeabilizzazione di giunti e spigoli e/o zone di raccordo tra il piano orizzontale e verticale.

Dimensione: 12 x 50 cm

Rubberised polyester fabric articles for waterproofing expansion joints and gaps between vertical and horizontal planes.

Dimension: 12 x 50 cm

Complementos en tejido de poliéster engomado para impermeabilizar juntas de dilatación y / o zonas de conexión entre el plano vertical y horizontal para orificios pasantes

Dimensión: 12 x 50 cm

guarnizione piccola



Complemento in tessuto poliestere gommato per l'impermeabilizzazione di giunti e spigoli e/o zone di raccordo tra il piano verticale e orizzontale per fori passanti

Dimensione: 12 x 12 cm

Rubberised polyester fabric articles for waterproofing expansion joints and gaps between vertical and horizontal planes for bore holes.

Dimension: 12 x 12 cm

Complementos en tejido de poliéster engomado para impermeabilizar juntas de dilatación y / o zonas de unión entre el plano vertical y horizontal para orificios pasantes

Dimensión: 12 x 12 cm

guarnizione grande



Complemento in tessuto poliestere gommato per l'impermeabilizzazione di giunti e spigoli e/o zone di raccordo tra il piano verticale e orizzontale per fori passanti

Dimensione: 42,5 x 42,5 cm

Rubberised polyester fabric articles for waterproofing expansion joints and gaps between vertical and horizontal planes for bore holes.

Dimension: 42,5 x 42,5 cm

Complementos en tejido de poliéster engomado para impermeabilizar juntas de dilatación y / o zonas de unión entre el plano vertical y horizontal para orificios pasantes

Dimensión: 42,5 x 42,5 cm



DIVISIONE
PAVIMENTI IN RESINA

PAVI
MEN
TIIN
RE
SINA



resin fl

pavimentazioni industriali e civili

linee prodotti

impregnanti / antipolvere

promotori d'adesione

leganti per malte spatolate

rivestimenti a film sottile / spesso

rivestimenti murali

autolivellanti

protettivi e impermeabilizzanti

riempitivi minerali

poliurea

accessori

loors

epoxy primer wb

scheda
tecnicadata
sheetficha
técnica

| impregnante epossidico all'acqua | interno esterno | water-based epoxy impregnating agent | indoor outdoor | impregnante epoxidico al agua | interior exterior |
|--|--------------------|---|-------------------|--|----------------------|
| Formulato bicomponente a base di resina epossidica in emulsione acquosa, dotato di buona resistenza chimica, meccanica, all'acqua e all'abrasione. Se diluito con acqua, secondo le indicazioni, può essere utilizzato come impregnante rendendo il supporto antipolvere e facilmente pulibile. Il rivestimento può dare effetti di chiaro-scuro dovuti al diverso assorbimento del supporto. Primer per Aquapox. Per uso professionale. | | Two-pack epoxy resin-based formulation in aqueous emulsion, with good chemical, mechanical, water and abrasion resistance. When diluted with water, following the indications given below, it can be used as an impregnating agent, making the substrate dustproof and easy to clean. The coating can give chiaroscuro effects due to the different substrate absorption. Primer for Aquapox. For professional use. | | Formulación bicomponente con base de resina epoxidica en emulsión acuosa, dotada de buena resistencia química, mecánica, al agua y a la abrasión. Si se diluye con agua, según las indicaciones que se dan seguidamente, puede utilizarse como impregnante haciendo que el soporte sea antipolvo y muy fácil de limpiar. El revestimiento puede dar efectos de claro-oscuro, debido a la distinta absorción del soporte. Imprimación para Aquapox. Para uso profesional. | |
| Attrezzatura: pennello, rullo, airless Rapporto di catalisi: (A:B) 1:1 Diluizione: acqua - come primer: 30% come impregnante antipolvere: 200% Resa (1 mano): come primer 100-150 g/m ² - Per confezione (8+8 kg): 208 m ² ; come impregnante antipolvere 50-100 g/m ² - Per confezione (8+8 kg): 960 m ² Colore: incolore | | Equipment: brush, roller, airless Mixing ration: (A:B) 1:1 Dilution: water - as primer: 30% impregnating agent: 200% Coverage (1 coat): as primer 100-150 g/m ² - Per package (8+8 kg): 208 m ² ; impregnating agent 50-100 g/m ² - Per package (8+8 kg): 960 m ² Color: transparent | | Herramientas: brocha, rodillo, pistola pulverizadora Relación de catalisis: (A:B) 1:1 Dilución: agua - Como imprimación: 30 % como impregnante antipolvo: 200% Rendimiento (1 capa): Como imprimación 100-150 g/m ² - Por envase (8+8 kg): 208 m ² ; como impregnante antipolvo 50-100 g/m ² - Por envase (8+8 kg): 960 m ² Color: incoloro | |

| tecniche | certificazioni | proprietà | tecnologie |
|--|----------------|-----------|------------|
|  WATER BASED  BRUSH  ROLLER  AIRLESS | | | |

epoxy primer xb

scheda
tecnicadata
sheetficha
técnica

| impregnante epossidico in fase solvente | interno esterno | epoxy impregnating agent diluted in solvent | indoor outdoor | impregnante epoxidico en disolución | interior exterior |
|--|--------------------|--|-------------------|--|----------------------|
| Formulato epossidico bicomponente trasparente a base di resine epossidiche e addotti sciolti in solventi appropriati, dotato di eccezionale adesione su supporti, ottima resistenza agli agenti atmosferici e chimici, idoneo per applicazioni in atmosfera industriale e marina. Appropriato come impregnante e promotore di adesione quando il manufatto deve essere finito con pitture epossidiche, epossiviniliche, poliuretaniche o clorocaucciù. Primer per Ivaglass. Per uso professionale. | | Two-pack, transparent epoxy resin-based formulation containing adducts dissolved in appropriate solvents. Offers exceptional adhesion on mineral substrates, superb resistance to atmospheric and chemical agents, ideal for applications in industrial and marine atmospheres. Particularly suitable as impregnation coat and adhesion promoter when the element is to be finished with epoxy, epoxy-vinyl, polyurethane or chlorinated-rubber paints. Primer for Ivaglass. For professional use. | | Formulación epoxidica bicomponente transparente a base de resinas epoxidicas y aductos disueltos en solventes apropiados, dotado de excepcional adhesión sobre soportes minerales, excelente resistencia a los agentes atmosféricos y químicos, idóneo para aplicaciones en atmósfera industrial y marina. Particularmente indicado como capa de impregnación y promotor de adhesión cuando el elemento deba recibir acabado con pinturas epoxidicas, epoxivinilicas, poliuretánicas o clorocaucho. Imprimación para Ivaglass. Para uso profesional. | |
| Attrezzatura: pennello, rullo, airless Rapporto di catalisi: (A:B) 1:1 Diluizione: pronto uso Resa (1 mano): 150-250 g/m ² - Per confezione (20+20 kg): 130 m ² Colore: incolore | | Equipment: brush, roller, airless Mixing ration: (A:B) 1:1 Dilution: ready to use Coverage (1 coat): 150-250 g/m ² - Per package (20+20 kg): 130 m ² Color: transparent | | Herramientas: brocha, rodillo, pistola pulverizadora Relación de catalisis: (A:B) 1:1 Dilución: listo para usar Rendimiento (1 capa): 150-250 g/m ² - Por envase (20+20 kg): 130 m ² Color: incoloro | |

| tecniche | certificazioni | proprietà | tecnologie |
|--|----------------|-----------|------------|
|  WATER BASED  BRUSH  ROLLER  AIRLESS | | | |

primer mma



scheda
tecnica



data
sheet



ficha
técnica



| | | |
|--|--|---|
| impregnante monocomponente in fase solvente interno esterno | single-component impregnating agent in the solvent phase indoor outdoor | impregnante monocomponente en fase disolvente interior exterior |
| Impregnante monocomponente trasparente a base di resine metacriliche in solvente per superfici in cls e malte cementizie. Presenta una buona resistenza alla contaminazione da oli, ai raggi UV ed attraverso speciali polimeri termoplastici, esplica azione protettiva, consolidante ed idrofobizzante sui supporti trattati. Per uso professionale. | One-pack, transparent, methacrylic resin-based impregnating agent in solvent for concrete and cement-based mortars. Offers good resistance to UV rays, to contamination from mineral oils and is waterproof. With its special thermoplastic polymers, Protects, consolidates and waterproofs the treated substrates. For professional use. | Impregnante monocomponente transparente a base de resinas metacrilicas en disolvente para superficies en cls y morteros de cemento. Es resistente a los rayos UV, presenta una buena resistencia a la contaminación por aceites minerales, impermeable. Primer A través de polimeros termoplásticos especiales, ejerce una acción protectora, consolidante e hidro-repelente sobre los soportes tratados. Para uso profesional. |
| Attrezzatura: pennello, rullo, airless Diluizione: pronto uso Resa (1 mano): 100-150 g/m ² - Per confezione (20 kg): 200 m ² Colore: incolore | Equipment: brush, roller, airless Dilution: ready to use Coverage (1 coat): 100-150 g/m ² - Per package (20 kg): 200 m ² Color: transparent | Herramientas: brocha, rodillo, pistola pulverizadora Dilución: listo para usar Rendimiento (1 capa): 100-150 g/m ² - Por envase (20 kg): 200 m ² Color: incolore |

| tecniche | | | | certificazioni | | | | proprietà | | | | tecnologie | | | | |
|---------------|-------|--------|---------|----------------|--|--|--|-----------|--|--|--|------------|--|--|--|--|
| | | | | | | | | | | | | | | | | |
| SOLVENT BASED | BRUSH | ROLLER | AIRLESS | | | | | WALKABLE | | | | | | | | |

epoxy fondo

scheda
tecnicadata
sheetficha
técnica

| promotore adesione epossidico | interno | epoxy adhesion promoter | indoor | promotor de adhesión epoxidico | interiores |
|--|---------|--|--------|---|------------|
| <p>Promotore di adesione epossidico per pavimentazioni e rivestimenti. Formulato bicomponente a base di resine epossidiche contenente fillers minerali ed extenders in polvere, specifico per:</p> <p>a) usato tal quale per promuovere l'adesione delle fasi successive sul supporto b) additivato con carica quarzifera per realizzare rasature come fondi per pavimentazioni resinose. Per uso professionale.</p> <p>Attrezzatura: pennello, rullo a pelo corto, spatole dentate per l'applicazione a spessore Rapporto di catalisi: come promotore di adesione (A:B) 80:20; come rasante di fondo (A:B:C) 80:20:70 Diluizione: Diluente per Epossidici - max 15% Resa: come promotore di adesione: 0,35 kg/m²; come rasante di fondo: 1,7 kg/m² per mm di spessore Colore: incolore</p> | | <p>Two-pack epoxy resin-based formulation containing mineral fillers and powder extenders, specifically:</p> <p>a) used 'as is' to promote adhesion of subsequent phases to the substrate b) with the addition of quartz filler to create base skim coats for the resin-based flooring. For professional use.</p> <p>Equipment: brush, roller, serrated spatulas for thick-coat application Mixing ration: as adhesion promoter(A:B) 80:20; as skimming base coat(a:b:c) 80:20:70 Dilution: Diluente per Epossidici - max 15% Coverage: as adhesion promoter: 0,35 kg/m²; as skimming base coat: 1,7 kg/m² per mm of thickness Color: transparent</p> | | <p>Formulación bicomponente a base de resinas epoxidicas con rellenos minerales y extender en polvo, especifica para:</p> <p>a) usado tal cual para promover la adhesión de las fases sucesivas en el soporte b) aditivado con carga de cuarzos para realizar enrasados como fondos para suelos resinosos. Para uso profesional.</p> <p>Herramientas: rodillos o brochas, espátulas dentadas para la aplicación en espesor Relación de catalisis: como promotor de adhesión A : B = 80 : 20 como mortero de enrasado de fondo A : B : C = 80 : 20 : 70 Diluición: Diluente per Epossidici - max 15% Rendimiento: como promotor de adhesión: 0,35 kg/m²; como mortero de enrasado de fondo: 1,7 kg/m² por mm de espesor Color: incoloro</p> | |

| tecniche | certificazioni | proprietà | tecnologie |
|---|----------------|-----------|------------|
|  SOLVENT BASED  BRUSH  ROLLER  TROWEL | | | |

epoxy fondo oil

scheda
tecnicadata
sheetficha
técnica

| promotore di adesione per fondi unti | interno | two-pack adhesion promoter for greasy substrates | indoor | promotor de adhesión para fondos con aceites | interiores |
|---|---------|---|--------|---|------------|
| <p>Promotore di adesione epossidico bicomponente per fondi unti. Epoxy Fondo Oil è uno speciale primer di ancoraggio per superfici cementizie sporche di olio, previa una specifica preparazione del sottofondo. Per uso professionale.</p> <p>Attrezzatura: pennello, rullo, airless Rapporto di catalisi: (A:B) 89:11 Diluizione: pronto uso Resa (1 mano): 500-600 g/m² - Per confezione (4,45+0,55 kg): 10 m² Colore: grigio</p> | | <p>Two-pack epoxy-based adhesion promoter for greasy substrates Epoxy Fondo Oil is a special anchoring primer for cement-based surfaces soiled with oil, to be applied after specific preparation of the substrate. For professional use.</p> <p>Equipment: brush, roller, airless Mixing ration: (A:B) 89:11 Dilution: ready to use Coverage (1 coat): 500-600 g/m² - Per package (4,45+0,55 kg): 10 m² Color: grey</p> | | <p>Promotor de adhesión epoxidico bicomponente para fondos con aceites. Epoxy Fondo Oil es una imprimación de anclaje especial para superficies de cemento manchadas de aceite, previa preparación específica del sustrato. Para uso profesional.</p> <p>Herramientas: brocha, rodillo, pistola pulverizadora Relación de catalisis: (A:B) 89:11 Dilución: listo para usar Rendimiento (1 capa): 500-600 g/m² - Por envase (4,45+0,55 kg): 10 m² Color: gris</p> | |

| tecniche | certificazioni | proprietà | tecnologie |
|--|----------------|-----------|------------|
|  WATER BASED  BRUSH  ROLLER  AIRLESS | | | |

epoxy fondo as



scheda
tecnica



data
sheet



ficha
técnica



| | | |
|---|---|--|
| <p>promotore di adesione epossidico conduttivo</p> <p>interno</p> | <p>conductive epoxy-based adhesion promoter</p> <p>indoor</p> | <p>promotor de adhesión epoxidico conductor</p> <p>interiores</p> |
| <p>Formulato bicomponente a base di resine epossidiche in fase di solvente, fillers pregiati conduttivi, idoneo per la realizzazione di fondi per cicli di pavimentazioni autolivellanti antistatici. Per uso professionale.</p> | <p>Two-pack epoxy resin based formulation diluted in solvent, prime quality conductive fillers, suited to the creation of substrates for antistatic self-levelling flooring applications. For professional use.</p> | <p>Formulación bicomponente a base de resinas epoxidicas en disolución, rellenos preciados conductores, adecuada para la realización de fondos para ciclos de pisos autonivelantes antistáticos. Para uso profesional.</p> |
| <p>Attrezzatura: pennello, rullo, airless Rapporto di catalisi: (A:B) 80:20 Diluizione: pronto all'uso Resa (1 mano): 150-200 g/m² - Per confezione (3+0,750 kg): 25 m² Colore: nero</p> | <p>Equipment: brush, roller, airless Mixing ratio: (A:B) 80:20 Dilution: ready to use Coverage (1 coat): 150-200 g/m² - Per package (3+0,750 kg): 25 m² Color: black</p> | <p>Herramientas: brocha, rodillo, pistola pulverizadora Relación de catálisis: (A:B) 80:20 Dilución: listo para usar Rendimiento (1 capa): 150-200 g/m² - Por envase (3+0,750 kg): 25 m² Color: negro</p> |

| tecniche | certificazioni | proprietà | tecnologie |
|---|----------------|-----------|------------|
| SOLVENT BASED BRUSH ROLLER AIRLESS | | | |

aquacem



scheda
tecnica



data
sheet



ficha
técnica



| | | |
|--|--|--|
| <p>primer tricomponente per fondi umidi</p> <p>interno esterno</p> | <p>three-pack primer for damp substrates</p> <p>indoor outdoor</p> | <p>imprimación tricomponente para fondos húmedos</p> <p>interior exterior</p> |
| <p>Promotore di adesione epossicementizio tricomponente, a base di resine epossidiche in emulsione acquosa, cemento, addotti, inerti. Idoneo per fondi umidi. Per uso professionale.</p> | <p>Three-pack epoxy-cement adhesion promoter, based on epoxy resins in water emulsion, cement, adducts, and inert materials. Suitable for damp substrates. For professional use.</p> | <p>Promotor de adhesión epoxicementoso tricomponente, a base de resinas epoxidicas en emulsión acuosa, cemento, aductos, inertes. Idóneo para fondos húmedos. Para uso profesional.</p> |
| <p>Attrezzatura: pennello, rullo, spatola Rapporto di catalisi: (A:B:C) 1:2:5 Diluizione: acqua - pennello, rullo max 15% - spatola pronto all'uso Resa: 1,5 kg/m² per mm di spessore Colore: grigio</p> | <p>Equipment: brush, roller, spatula Mixing ratio: (A:B:C) 1:2:5 Dilution: water - brush, roller max 15% - spatula: ready to use Coverage: 1,5 kg/m² per mm of thickness Color: grey</p> | <p>Herramientas: brocha, rodillo, espátula Relación de catálisis: (A:B:C) 1:2:5 Dilución: agua - brocha, rodillo max 15% - espátula listo para usar Rendimiento: 1,5 kg/m² per mm de espesor Color: gris</p> |

| tecniche | certificazioni | proprietà | tecnologie |
|--|----------------|-----------|------------|
| WATER BASED BRUSH ROLLER TROWEL | | | |

aquacem autolivellante



scheda
tecnica



data
sheet



ficha
técnica



| | | |
|---|--|---|
| <p>malta di fondo autolivellante</p> <p>interno esterno</p> | <p>self-levelling mortar for base coat</p> <p>indoor outdoor</p> | <p>mortero autonivelante para capa de fondo</p> <p>interior exterior</p> |
| <p>Malta autolivellante per strato di fondo per supporti cementizi umidi o in leggera contropinta, di pavimentazioni, serbatoi, fognature, vasche, canali. Formulato tri componente autolivellante ad alta resistenza a base di resine epossidiche in dispersione acquosa e leganti idraulici. Per uso professionale.</p> | <p>Self-levelling mortar for base coat on concrete substrates that are damp or present slight counterthrust, for flooring, tanks, sewers, basens, canals, etc. Two-pack, self-levelling, high resistance epoxy resin-based formulation dispersed in water and hydraulic binders. For professional use.</p> | <p>Mortero autonivelante para capa de fondo para soportes de cemento húmedos o en empuje negativo ligero, de suelos, depósitos, alcantarillados, cubas, canales. Fórmula bicomponente autonivelante de alta resistencia a base de resinas epoxidicas en dispersión acuosa y aglutinantes hidráulicos. Para uso profesional.</p> |
| <p>Attrezzatura: Spatola dentata e rullo frangibolle per l'applicazione a spessore Rapporto di catalisi: (A:B:C) 9:7:84 Diluizione: pronto uso Resa: 2 kg/m² per mm di spessore Colore: grigio</p> | <p>Equipment: Serrated spatula e bubble-buster roller for thick-coat application Mixing ratio: (A:B:C) 9:7:84 Dilution: ready to use Coverage: 2 kg/m² per mm of thickness Color: grey</p> | <p>Herramientas: Espátula dentada y rodillo antiburbujas para aplicación de espesor Relación de catálisis: (A:B:C) 9:7:84 Dilución: listo para usar Rendimiento: 2 kg/m² per mm de espesor Color: gris</p> |

| tecniche | certificazioni | proprietà | tecnologie |
|---------------------------------|----------------|-----------|------------|
| WATER BASED ROLLER TROWEL | | | |

epoxy bond



 scheda
tecnica

 data
sheet

 ficha
técnica

| legante bicomponente per malte | interno | two-pack binder for mortars | indoor | Aglutinante bicomponente para morteros | interiores |
|---|---------|---|--------|--|------------|
| <p>Legante bicomponente a base di resine epossidiche, esente da solventi, trasparente, per la realizzazione di massetti di spessore variabile tra 5 e 10 mm. Idoneo per la realizzazione di malte resinose per pavimentazioni industriali ad alta resistenza meccanica. Per uso professionale.</p> <p>Attrezzatura: Stagge e frattazzi manuali o meccanici, rullo in lana a pelo corto Rapporto di catalisi: (A:B) 66:33 Diluizione: pronto uso Resa: 2 kg/m² per mm di spessore Colore: grigio Color: incolore</p> | | <p>Two pack, solvent-free, transparent epoxy resin binder to produce screeds with thickness ranging from 5 to 10 mm. Ideal for resin mortars for industrial floorings requiring high mechanical resistance. For professional use.</p> <p>Equipment: Manual or mechanical leveling bars and trowels, roller Mixing ration: (A:B) 66:33 Dilution: ready to use Coverage: 2 kg/m² per mm of thickness Colours: grey Color: transparent</p> | | <p>Aglutinante bicomponente a base de resinas epoxídicas, sin disolventes, para la realización de soleras de espesor variable entre 5 y 10 mm. Idóneo para la realización de morteros resinosos para suelos industriales de alta resistencia mecánica. Para uso profesional.</p> <p>Herramientas: Reglas y llanas manuales o mecánicas Relación de catálisis: (A:B) 66:33 Dilución: listo para usar Rendimiento: 2 kg/m² per mm de espesor Color: gris Color: incoloro</p> | |

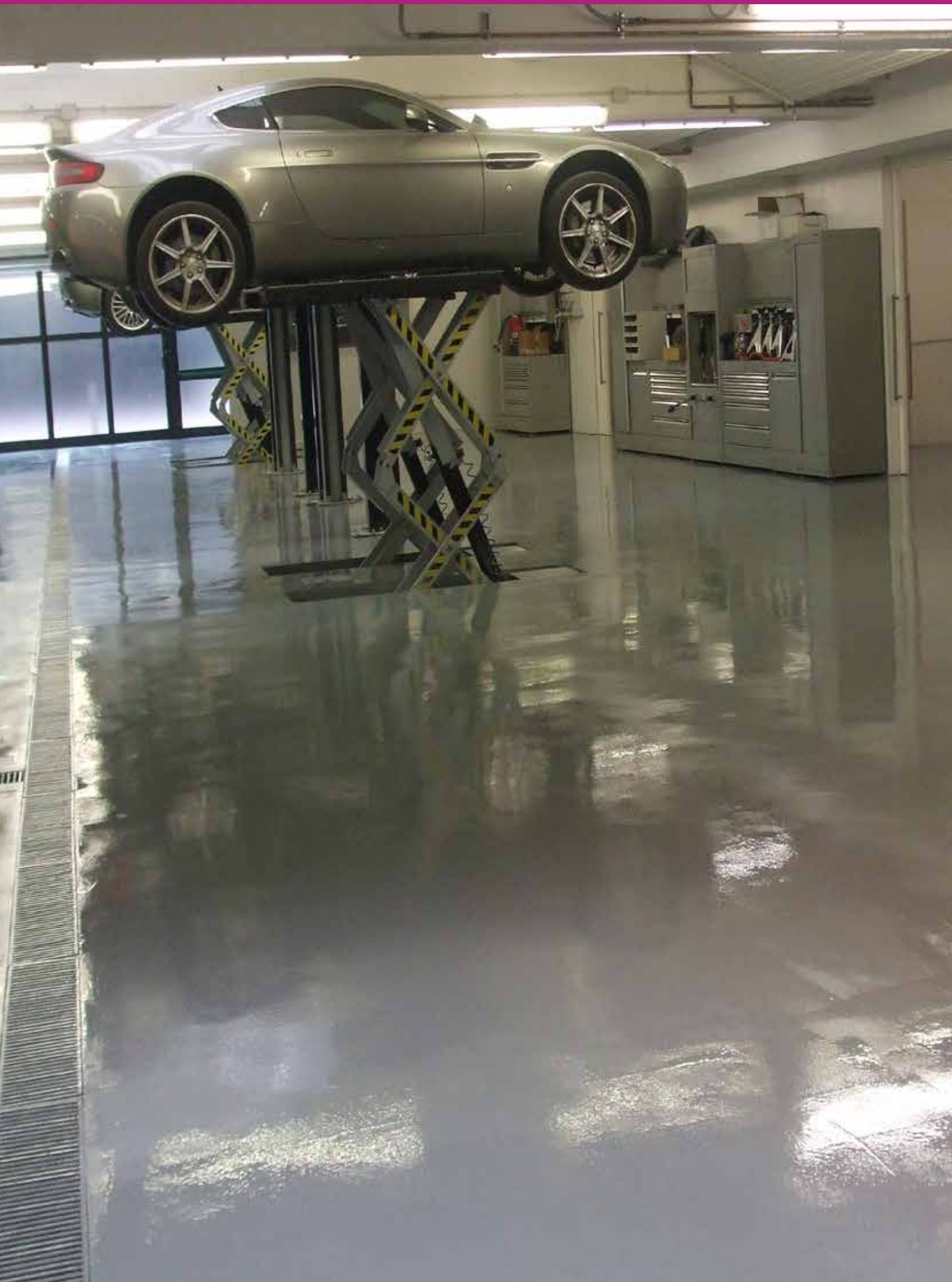
| tecniche | | certificazioni | | | | proprietà | | | | tecnologie | | | |
|--|---|----------------|--|--|--|-----------|--|--|--|------------|--|--|--|
|  |  | | | | | | | | | | | | |
| TROWEL | ROLLER | | | | | | | | | | | | |



aquapox

scheda
tecnicadata
sheetficha
técnica

| | | | | | |
|---|----------------|--|---------------|--|-------------------|
| smalto all'acqua dall'elevata resistenza | interno | highly resistant water-based enamel | indoor | esmalte al agua de alta resistencia | interiores |
| Rivestimento epossidico bicomponente in dispersione acquosa per film sottile. Particolarmente idoneo per il trattamento di superfici sia orizzontali che verticali, che richiedono elevate resistenze meccaniche, chimiche e all'idrolavaggio. Certificato come verniciatura di ambienti con presenza di alimenti secondo la norma UNI 11020:2002. Per uso professionale. | | Two-pack, epoxy resin-based coating in aqueous dispersion for thin films. Particularly suited for treating horizontal and vertical surfaces requiring high mechanical and chemical resistance and high resistance to high-pressure washing. Certified as paint for areas where foodstuffs are present, in accordance with UNI 11020:2002 standard. For professional use. | | Revestimiento epoxídico bicomponente en dispersión acuosa para película fina. Particolarmente idóneo para el tratamiento de superficies, tanto horizontales como verticales, que requieran elevadas resistencias mecánicas, químicas y para hidrolavado. Certificado como barniz para espacios con presencia de alimentos según la norma UNI 11020:2002. Para uso profesional. | |
| Attrezzatura: pennello, rullo, airless Rapporto di catalisi: (A:B) 70:30 Diluizione: acqua - max 10-20% Resa (2 mani): 3-3,5 m ² /l - Per confezione (10,5+4,5 kg): 56 m ² Colore: colorato | | Equipment: brush, roller, airless Mixing ration: (A:B) 70:30 Dilution: water - max 10-20% Coverage (2 coats): 3-3,5 m ² /l - Per package (10,5+4,5 kg): 56 m ² Color: colored | | Herramientas: brocha, rodillo, pistola pulverizadora Relación de catalisis: (A:B) 70:30 Dilución: agua - max 10-20% Rendimiento (2 capas): 3-3,5 m ² /l - Por envase (10,5+4,5 kg): 56 m ² Color: colorido | |

| tecniche | certificazioni | proprietà | tecnologie |
|--|----------------|--|--|
|  WATER BASED  BRUSH  ROLLER  AIRLESS | |  CARRIAGEABLE |  resistance 4 |

epoxy paint ht

scheda
tecnicadata
sheetficha
técnica

| | | | | | |
|---|----------------|---|---------------|---|-------------------|
| rivestimento epossidico per film spesso | interno | epoxy resin-based coating for thick film | indoor | revestimiento epoxídico para película gruesa | interiores |
| Rivestimento epossidico bicomponente per film spesso pigmentato, esente da solventi, per rivestimenti di pavimentazioni industriali con buone resistenze chimiche, ottima impermeabilità ad oli ed agenti aggressivi, ottima resistenza ai lavaggi e all'usura causata dal traffico leggero di carrelli. Contiene fillers minerali specifici per la realizzazione di finiture lucide di pavimentazioni a film spesso compreso tra 0.2 e 1 mm e rivestimenti multistrato compresi tra 1 e 3 mm ad effetto liscio e monocromatico. Per uso professionale. | | Solvent-free, two-pack, pigmented thick film, epoxy resin-based coating for industrial flooring with good chemical resistance, excellent impermeability to oils and aggressive agents, excellent resistance to washing and wear caused by light trolley traffic. Contains mineral fillers specifically designed for the creation of glossy floor finishes with a thick film between 0.2 and 1.0 mm and multi-layer coatings between 1 and 3 mm thick with a smooth, monochromatic effect. For professional use. | | Revestimiento epoxídico bicomponente para película gruesa pigmentada, sin solventes, para revestimiento de suelos industriales con buena resistencia química, excelente impermeabilidad a los aceites y agentes agresivos, excelente resistencia a los lavados y al desgaste causado por tráfico ligero de carritos. Contiene rellenos minerales específicos para la realización de acabados brillantes de suelos con película de espesor entre 0,2 y 1 mm, y revestimientos multicapa entre 1 y 3 mm de efecto liso y monocromático. Para uso profesional. | |
| Attrezzatura: rullo a pelo corto Rapporto di catalisi: (A:B) 80:20 Diluizione: Diluente per Epossidici - max 5% Resa (2 mani): 500-700 g/m ² - Per confezione (16+4 kg): 40 m ² Colore: colorato | | Equipment: roller Mixing ration: (A:B) 80:20 Dilution: Diluente per Epossidici - max 5% Coverage (2 coats): 500-700 g/m ² - Per package (16+4 kg): 40 m ² Color: colored | | Herramientas: rodillo a pelo corto Relación de catalisis: (A:B) 80:20 Dilución: Diluente per Epossidici - max 5% Rendimiento (2 capas): 500-700 g/m ² - Por envase (16+4 kg): 40 m ² Color: colorido | |

| tecniche | certificazioni | proprietà | tecnologie |
|---|----------------|--|------------|
|  SOLVENT BASED  BRUSH  ROLLER  TROWEL | |  CARRIAGEABLE | |

epoxy paint It



scheda
tecnica



data
sheet



ficha
técnica



| | | |
|---|--|---|
| rivestimento epossidico per film sottile interno | epoxy resin-based coating for thin film indoor | revestimiento epoxídico para película fina interiores |
| Rivestimento bicomponente a base di resine epossidiche in fase solvente, pigmenti e cariche pregiate, caratterizzato da buone resistenze agli agenti chimici e superficiali. Idoneo per la realizzazione di rivestimenti a film di spessore compresi tra 100 e 200 µm su pavimentazioni industriali a traffico leggero. I rivestimenti che si ottengono sono impermeabili all'acqua, agli oli e al vapore. Per uso professionale. | Two-pack epoxy resin-based coating in solvent phase. Contains pigments and prime quality fillers that offer good resistance to chemical and surface agents. Suitable for film coating of industrial floors subject to light traffic, car parks, warehouses — thickness ranging between 100 and 200 µm. The resulting coatings are impermeable to water, oil and steam. For professional use. | Revestimiento bicomponente a base de resinas epoxídicas en disolución, pigmentos y cargas refinadas, caracterizado por buenas resistencias a los agentes químicos y superficiales. Idóneo para la realización de películas de revestimiento con espesores entre 100 y 200 µm sobre suelos industriales de tráfico ligero, depósitos de vehículos, almacenes. Los revestimientos que se obtienen son impermeables al agua, a los aceites y al vapor. Para uso profesional. |
| Attrezzatura: pennello, rullo, airless Rapporto di catalisi: (A:B) 75:25 Diluizione: Diluente per Epossidici - max 10% Resa (2 mani): 0,3-0,4 kg/m ² pari ad uno spessore di circa 150/200 micron - Per confezione (12+4 kg): 6,6 m ² Colore: colorato | Equipment: brush, roller, airless Mixing ration: (A:B) 75:25 Dilution: Diluente per Epossidici - max 10% Coverage (2 coats): 0,3-0,4 kg/m ² approx. 150/200 micron Per package (12+4 kg): 6,6 m ² Color: colored | Herramientas: brocha, rodillo, pistola pulverizadora Relación de catálisis: (A:B) 75:25 Dilución: Diluente per Epossidici - max 10% Rendimiento (2 capas): 0,3-0,4 kg/m ² igual a un espesor de aprox.150/200 micron- Por envase (12+4 kg): 6,6 m ² Color: colorido |

| tecniche | certificazioni | proprietà | tecnologie |
|---|----------------|--------------|------------|
| SOLVENT BASED BRUSH ROLLER AIRLESS | | CARRIAGEABLE | |

davis paint



scheda
tecnica



data
sheet



ficha
técnica



| | | |
|---|--|--|
| microrivestimento antiscivolo esterno | non-slip micro-coating outdoor | micro-revestimiento antideslizante steriores |
| Microrivestimento monocomponente acrilico all'acqua. Particolarmente idoneo per pavimentazioni in asfalto, cementizie, sintetiche, bituminose (campi da tennis). Ottimo anche su supporti murari. Il film è impermeabile, resistente agli alcali, all'abrasione, alle intemperie in atmosfere moderatamente industriali. Per uso professionale. | One-pack, water-based micro-coating. Ideal for asphalt, concrete, synthetic, bituminous floorings (tennis courts). Superb also on masonry substrates. The film is waterproof, resistant to alkalis, abrasion and bad weather in moderately industrial atmospheres. For professional use. | Micro-revestimiento monocomponente al agua. Particolarmente idóneo para pisos en asfalto, cemento, sintéticos, bituminosos (campos de tenis). Excelente también en paredes. La película es impermeable, resistente a los álcalis, a la abrasión, a la intemperie en atmósferas moderadamente industriales. Para uso profesional. |
| Attrezzatura: pennello, rullo, airless Diluizione: acqua - max 25% Resa (2 mani): 4-5 m ² /l - Per confezione (14 l): 70 m ² Colore: Verde, Rosso tennis, Bianco | Equipment: brush, roller, airless Dilution: water - max 25% Coverage (2 coats): 4-5 m ² /l - Per package (14 l): 70 m ² Color: Green, tennis court clay Red, White | Herramientas: brocha, rodillo, pistola pulverizadora Dilución: agua - max 25% Rendimiento (2 capas): 4-5 m ² /l - Por envase (14 l): 70 m ² Color: Verde, Rojo tennis, Blanco |

| tecniche | certificazioni | proprietà | tecnologie |
|---|----------------|-----------|------------|
| WATER BASED BRUSH ROLLER AIRLESS | | WALKABLE | |

paviglass lucido

scheda
tecnicadata
sheetficha
técnica

| smalto a solvente ad elevata resistenza | interno esterno | highly resistant solvent-based enamel | indoor outdoor | esmalte con disolvente de alta resistencia. | interior exterior |
|---|--------------------|---|-------------------|--|----------------------|
| Formulato acrilpoliuretano bicomponente, induritore isocianato alifatico non ingiallente, idoneo per rivestimenti di pavimentazioni industriali con buone resistenze chimiche e agli oli, adatto quindi per industrie chimiche, farmaceutiche, meccaniche, elettriche, garage e autorimesse. Per uso professionale. | | Two-pack acrylic-polyurethane formulation, non-yellowing, aliphatic, isocyanate hardener, suitable for coating industrial flooring requiring good resistance to chemicals and oils. It is thus particularly suited for use in chemical, pharmaceutical, mechanical, electrical industries and in garages and covered car parks. For professional use. | | Fórmula acrilpoliuretánica bicomponente, endurecedor isocianato alifático, no amarillea, idóneo para revestimientos de pisos industriales con buenas resistencias químicas y a los aceites, adecuado, por tanto, para industrias químicas, farmacéuticas, mecánicas, eléctricas, garajes y cocheras. Para uso profesional. | |
| Attrezzatura: pennello, rullo, airless Rapporto di catalisi: (A:B) 3:1 Diluizione: Diluente per Poliuretani (non utilizzare diluenti nitro) - max 10% Resa (2 mani): 4-4,5 m ² /l - Per confezione (12+4 l): 70 m ² Colore: colorato | | Equipment: brush, roller, airless Mixing ration: (A:B) 3:1 Dilution: Diluente per Poliuretani (do not use diluenti nitro) - max 10% Coverage (2 coats): 4-4,5 m ² /l - Per package (12+4 l): 70 m ² Color: colored | | Herramientas: brocha, rodillo, pistola pulverizadora Relación de catálisis: (A:B) 3:1 Dilución: Diluente per Poliuretani (no utilizar diluenti nitro) - max 10% Rendimiento (2 capas): 4-4,5 m ² /l - Por envase (12+4 l): 70 m ² Color: colorido | |

| tecniche | certificazioni | proprietà | tecnologie |
|----------|----------------|-----------|------------|
| | | | |

paviglass opaco

scheda
tecnicadata
sheetficha
técnica

| smalto a solvente ad elevata resistenza | interno esterno | highly resistant solvent-based enamel | indoor outdoor | esmalte con disolvente de alta resistencia. | interior exterior |
|---|--------------------|---|-------------------|--|----------------------|
| Formulato acrilpoliuretano bicomponente, induritore isocianato alifatico non ingiallente, idoneo per rivestimenti di pavimentazioni industriali con buone resistenze chimiche e agli oli, adatto quindi per industrie chimiche, farmaceutiche, meccaniche, elettriche, garage e autorimesse. Per uso professionale. | | Two-pack acrylic-polyurethane formulation, non-yellowing, aliphatic, isocyanate hardener, suitable for coating industrial flooring requiring good resistance to chemicals and oils. It is thus particularly suited for use in chemical, pharmaceutical, mechanical, electrical industries and in garages and covered car parks. For professional use. | | Fórmula acrilpoliuretánica bicomponente, endurecedor isocianato alifático, no amarillea, idóneo para revestimientos de pisos industriales con buenas resistencias químicas y a los aceites, adecuado, por tanto, para industrias químicas, farmacéuticas, mecánicas, eléctricas, garajes y cocheras. Para uso profesional. | |
| Attrezzatura: pennello, rullo, airless Rapporto di catalisi: (A:B) 3:1 Diluizione: Diluente per Poliuretani (non utilizzare diluenti nitro) - max 10% Resa (2 mani): 4-4,5 m ² /l - Per confezione (12+4 l): 70 m ² Colore: colorato | | Equipment: brush, roller, airless Mixing ration: (A:B) 3:1 Dilution: Diluente per Poliuretani (do not use diluenti nitro) - max 10% Coverage (2 coats): 4-4,5 m ² /l - Per package (12+4 l): 70 m ² Color: colored | | Herramientas: brocha, rodillo, pistola pulverizadora Relación de catálisis: (A:B) 3:1 Dilución: Diluente per Poliuretani (no utilizar diluenti nitro) - max 10% Rendimiento (2 capas): 4-4,5 m ² /l - Por envase (12+4 l): 70 m ² Color: colorido | |

| tecniche | certificazioni | proprietà | tecnologie |
|----------|----------------|-----------|------------|
| | | | |



ivapox antiacido

 scheda
tecnica

 data
sheet

 ficha
técnica

| smalto bicomponente antiacido | interno | two-pack anti-acid enamel | indoor | esmalte bicomponente antiácido | interiores |
|---|---------|--|--------|---|------------|
| <p>Smalto formulato a base di resine epossidiche non modificate, bicomponente, esente da solventi. Particolarmente indicato per la protezione di manufatti da aggressivi chimici sia acidi diluiti che soluzioni altamente alcaline, oli, vegetali, soluzione saline e alcuni tipi di solventi. Tali capacità di resistenza si realizzano al 100% solo ad indurimento totale, cioè almeno dopo 7 giorni dall'applicazione. Per uso professionale.</p> | | <p>Two-pack solvent-free, non modified epoxy resin-based enamel with superb chemical characteristics and good physical and mechanical properties. Particularly suited to protect surfaces from chemical agents such as diluted acids and highly alkaline solutions, mineral and vegetable oils, saline solutions and some types of solvents. 100% resistance is only achieved after full hardening time has elapsed, that is 7 days after application. For professional use.</p> | | <p>Formulación a base de resinas epoxídicas no modificadas, bicomponente, sin disolventes. Particolarmente indicado para proteger objetos de agentes químicos agresivos, tanto ácidos diluidos como soluciones altamente alcalinas, aceites minerales, vegetales, soluciones salinas y algunos tipos de disolventes. Estas capacidades de resistencia se realizan al 100 % solo una vez endurecido completamente, es decir, al menos 7 días después de la aplicación. Para uso profesional.</p> | |
| <p>Attrezzatura: pennello, rullo, airless Rapporto di catalisi: (A:B) 80:20 Diluizione: pronto uso Resa (2 mani): 250-300 g/m² - Per confezione (16+4 kg): 80 m² Colore: Grigio, Rosso Ossido, Giallo Ocre, Verde</p> | | <p>Equipment: brush, roller, airless Mixing ration: (A:B) 80:20 Dilution: ready to use Coverage (2 coats): 250-300 g/m² - Per package (16+4 kg): 80 m² Color: Grey, Oxide Red, Ochre Yellow, Green</p> | | <p>Herramientas: brocha, rodillo, pistola pulverizadora Relación de catálisis: (A:B) 80:20 Dilución: listo para usar Rendimiento (2 capas): 250-300 g/m² - Por envase (16+4 kg): 80 m² Color: Gris, Rojo Óxido, Amarillo Ocre, Verde</p> | |

| tecniche | | | certificazioni | | | proprietà | | | tecnologie | | |
|--|---|---|----------------|--|--|---|--|--|------------|--|--|
|  |  |  | | | |  | | | | | |
| BRUSH | ROLLER | AIRLESS | | | | CARRIAGEABLE | | | | | |



epoplast

 scheda
tecnica

 data
sheet

 ficha
técnica

| legante per malte autolivellanti | interno | binder for self-levelling mortars | indoor | aglutinante para morteros autonivelantes | interiores |
|--|---------|--|--------|--|------------|
| <p>Formulato bicomponente pigmentato a base di resine epossidiche, contenente fillers minerali ed extenders in polvere specifico per pavimentazioni industriali resinose, aventi caratteristiche meccaniche e chimiche idonee. Permette di realizzare malte autolivellanti aggiungendo al legante (comp. A + comp. B), la carica quarzifera (Comp. C) Quarzo 06 in rapporto 1:0,7 e di ottenere delle superfici con grado di finitura lucido. I rivestimenti sono impermeabili all'acqua ed agli oli e perfettamente lavabili con detersivi neutri. Per uso professionale.</p> | | <p>Two-pack pigmented epoxy resin-based formulation containing mineral fillers and powdered extenders for the creation of self-levelling mortars. EPOPLAST makes it possible to produce self-levelling mortars by adding the quartz filler Quarzo 06 (IVAS) (Pack C) to the binder (pack A + pack B) in a ratio of 1:0.7 and to obtain surfaces with a glossy finish. The coatings are waterproof, oil-proof and perfectly washable with neutral detergents. For professional use.</p> | | <p>Formulación bicomponente pigmentada con base de resinas epoxídicas, contiene rellenos minerales y extender en polvo; específica para suelos industriales resinosos, de características mecánicas y químicas adecuadas. Permite realizar morteros autonivelantes añadiendo al aglutinante (comp.A + comp.B), la carga de cuarzo (Comp.C) Quarzo 06 en relación 1:0,7 y obtener superficies con un grado de acabado brillante. Los revestimientos son impermeables al agua y a los aceites, y perfectamente lavables con detergentes neutros. Para uso profesional.</p> | |
| <p>Attrezzatura: pennello, rullo, airless Rapporto di catalisi: (A:B:C) 80:20:70 Diluizione: pronto uso Resa: 1,8 kg/m² per mm di spessore Colore: colorato</p> | | <p>Equipment: brush, roller, airless Mixing ration: (A:B:C) 80:20:70 Dilution: ready to use Coverage: 1,8 kg/m² per mm of thickness Color: colored</p> | | <p>Herramientas: brocha, rodillo, pistola pulverizadora Relación de catálisis: (A:B:C) 80:20:70 Dilución: listo para usar Rendimiento: 1,8 kg/m² per mm de espesor Color: colorido</p> | |

| tecniche | certificazioni | proprietà | tecnologie |
|----------------------------|----------------|--------------|------------|
| BRUSH ROLLER AIRLESS | | CARRIAGEABLE | |

epoplast w

 scheda
tecnica

 data
sheet

 ficha
técnica

| epossidica autolivellante a base acquosa | interno | water-based, self-levelling epoxy formulation | indoor | formulación epoxídica autonivelante al agua | interiores |
|---|---------|--|--------|--|------------|
| <p>Formulato bicomponente pigmentato a base di resine epossidiche in emulsione acquosa, per la realizzazione di malte autolivellanti. Per uso professionale.</p> | | <p>Two-pack pigmented epoxy resin-based formulation in aqueous emulsion, for the creation of self-levelling mortars. For professional use.</p> | | <p>Formulación bicomponente pigmentada con base de resinas epoxídicas en emulsión acuosa, para la realización de morteros autonivelantes. Para uso profesional.</p> | |
| <p>Attrezzatura: spatola dentata, rullo frangibolle Rapporto di catalisi: (A:B:C) 80:20:30 Diluizione: pronto uso Resa: 2 kg/m² per mm di spessore Colore: colorato</p> | | <p>Equipment: serrated spatula, bubble-buster roller Mixing ration: (A:B:C) 80:20:30 Dilution: ready to use Coverage: 2 kg/m² per mm of thickness Color: colored</p> | | <p>Herramientas: espátula dentada, rodillo antiburbujas Relación de catálisis: (A:B:C) 80:20:30 Dilución: listo para usar Rendimiento: 2 kg/m² per mm de espesor Color: colorido</p> | |

| tecniche | certificazioni | proprietà | tecnologie |
|---------------------------------|----------------|--------------|------------|
| WATER BASED TROWEL ROLLER | | CARRIAGEABLE | |

epoplast as



scheda
tecnica



data
sheet



ficha
técnica



| finitura ciclo autolivellante antistatica | interno | antistatic self-levelling cycle topcoat | indoor | acabado de ciclo autonivelante antiestático | interiores |
|---|---------|---|--------|---|------------|
| <p>Formulato bicomponente pigmentato a base di resine epossidiche, contenenti fillers conduttivi, idoneo per la realizzazione di finiture di cicli di pavimentazioni autolivellanti antistatiche secondo la norma UNI8298-10. La sinergia tra la proprietà antistatica e le notevoli caratteristiche meccaniche e chimiche, lo rendono specificamente indicato per industrie chimiche e farmaceutiche, ospedali e sale operatorie, industrie elettriche ed elettroniche, ambienti antidefragranti. Per uso professionale.</p> | | <p>Two-pack pigmented epoxy resin-based formulation containing conductive fillers, suited for finishing self-levelling antistatic flooring as per UNI8298-10. The synergy between antistatic characteristics and superb mechanical and chemical properties make Epoplast AS particularly suited to use in chemical and pharmaceutical industries, hospitals and operating theatres, precision engineering industries, electrical and electronic industries, flameproof environments For professional use.</p> | | <p>Formulación bicomponente pigmentada a base de resinas epoxídicas; contiene rellenos conductores, idónea para la realización de acabados de ciclos de pisos autonivelantes antiestáticos conforme a la norma UNI8298-10. La sinergia entre la propiedad antiestática y las notables características mecánicas y químicas, hacen Epoplast AS específicamente indicado para industrias químicas y farmacéuticas, hospitales y quirófanos, industrias mecánicas de precisión, industrias eléctricas y electrónicas, espacios antideflagrantes. Para uso profesional.</p> | |
| <p>Attrezzatura: spatola dentata, rullo Rapporto di catalisi: (A:B) 86:14 Diluizione: pronto uso Resa: 2,2 kg/m² per mm di spessore Colore: colorato</p> | | <p>Equipment: serrated spatula, roller Mixing ration: (A:B) 86:14 Dilution: ready to use Coverage: 2,2 kg/m² per mm of thickness Color: colored</p> | | <p>Herramientas: espátula dentada, rodillo Relación de catalísis: (A:B) 86:14 Dilución: listo para usar Rendimiento: 2,2 kg/m² per mm de espesor Color: colorido</p> | |

| tecniche | certificazioni | proprietà | tecnologie |
|--|----------------|--|------------|
|  SOLVENT BASED  TROWEL  ROLLER | |  CARRIAGEABLE | |

epoplast flex



scheda
tecnica



data
sheet



ficha
técnica



| epossi-poliuretano per malte autolivellanti | interno | epoxy-polyurethane formulation for self-levelling mortars | indoor | epoxi-poliuretánica para morteros autonivelantes | interiores |
|--|---------|--|--------|---|------------|
| <p>Formulato bicomponente tricomponente epossi-poliuretano pigmentato per la realizzazione di malte autolivellanti elastoplastiche pedonabili per pavimentazioni caratterizzate da buona resistenza meccanica e chimica, impermeabili a vapore, acqua, oli. Per uso professionale.</p> | | <p>Three-pack, epoxy-polyurethane formulation for walkable, elastoplastic self-levelling mortars for flooring that are impermeable to water vapour, water and oils and have a good mechanical and chemical resistance. For professional use.</p> | | <p>Formulación epoxi-poliuretánica tricomponente, para la realización de morteros autonivelantes elastoplásticos válidos para tránsito peatonal, para suelos caracterizados por una buena resistencia mecánica y química, impermeable al vapor, agua, aceite. Para uso profesional.</p> | |
| <p>Attrezzatura: pennello, rullo, airless Rapporto di catalisi: (A:B:C) 70:30:50 Diluizione: pronto uso Resa: 1,7 kg/m² per mm di spessore Colore: colorato</p> | | <p>Equipment: brush, roller, airless Mixing ration: (A:B:C) 70:30:50 Dilution: ready to use Coverage: 1,7 kg/m² per mm of thickness Color: colored</p> | | <p>Herramientas: brocha, rodillo, pistola pulverizadora Relación de catalísis: (A:B:C) 70:30:50 Dilución: listo para usar Rendimiento: 1,7 kg/m² per mm de espesor Color: colorido</p> | |

| tecniche | certificazioni | proprietà | tecnologie |
|---|----------------|--|------------|
|  BRUSH  ROLLER  AIRLESS | |  CARRIAGEABLE | |

polyelastic

 scheda
tecnica

 data
sheet

 ficha
técnica

| rivestimento autolivellante elastico | interno esterno | elastic self-levelling coating | indoor outdoor | revestimiento autonivelante elástico | interior exterior |
|---|----------------------------|--|---------------------------|---|------------------------------|
| Rivestimento autolivellante elastico bicomponente poliuretano per la realizzazione di malte autolivellanti elastoplastiche pedonabili, utilizzabile anche a rullo come rivestimento a basso spessore elastico. Per uso professionale. | | Two-pack elastic, polyurethane coating for the production of elastic-plastic self-levelling mortars that can be walked on; can also be applied by roller as a coating with low elastic thickness. For professional use. | | Revestimiento autonivelante elástico bicomponente poliuretánico para la realización de morteros autonivelantes elastoplásticos válidos para tránsito peatonal, utilizable también con rodillo como revestimiento de bajo espesor elástico. Para uso profesional. | |
| Attrezzatura: spatola dentata, rullo frangibolle Rapporto di catalisi: (A:B) 100:15 Diluizione: Diluente per Epossidici - max 15% Resa: 1,75 kg/m ² per mm di spessore Colore: colorato | | Equipment: serrated spatula, bubble-buster roller Mixing ration: (A:B) 100:15 Dilution: Diluente per Epossidici - max 15% Coverage: 1,75 kg/m ² per mm of thickness Color: colored | | Herramientas: Espátula dentada y rodillo antiburbujas para aplicación de espesor Relación de catalisis: (A:B) 100:15 Dilución: Diluente per Epossidici - max 15% Rendimiento: 1,75 kg/m ² per mm de espesor Color: colorido | |

| tecniche | certificazioni | proprietà | tecnologie |
|-----------------------------------|----------------|-----------|------------|
| SOLVENT BASED TROWEL ROLLER | | WALKABLE | |

epoplast 61

 scheda
tecnica

 data
sheet

 ficha
técnica

| resina epossidica autolivellante | interno | self-levelling epoxy resin | indoor | resina epoxídica autonivelante | interiores |
|---|----------------|---|---------------|---|-------------------|
| Formulato bicomponente a base di resine epossidiche modificate ed additivi speciali, trasparente, a bassa viscosità, pronto all'uso, a basso ingiallimento. L'indurimento avviene per reazione di poliaddizione senza alcun fenomeno di ritiro. Fattori ambientali durante l'indurimento possono provocare imperfezioni del film polimerizzato quali schivature, rugosità superficiali, piccoli rigonfiamenti, che però non pregiudicano in alcun modo le caratteristiche chimico - fisiche del prodotto. Il materiale è impermeabile al vapore, all'acqua, ai combustibili, a lubrificanti e presenta inoltre una elevata resistenza chimica alle soluzioni basiche e debolmente acide. Per uso professionale. | | Two-pack low-viscosity, transparent, ready-to-use formulation containing modified epoxy resins and special additives. Thanks to its particular low yellowing formulation, it makes transparent finishes possible. Hardening is achieved through a polyaddition reaction, without any shrinkage. During hardening, environmental factors can lead to imperfections in the polymerized film such as cissings, surface roughness, minor swelling; these do not in any way affect the product's chemical-physical properties. The material is impermeable to steam, water, fuels, lubricants and also offers high chemical resistance to basic and weakly acidic solutions. For professional use. | | Formulación bicomponente con base de resinas epoxídicas modificadas y aditivos especiales, transparente, de baja viscosidad, lista para usar, de bajo índice de amarilleo. El endurecimiento se produce por reacción de poliadición exento de fenómenos de retracción. Los factores ambientales durante el endurecimiento pueden provocar imperfecciones de la película polimerizada, como cráteres, rugosidades superficiales, pequeñas convexidades, que en todo caso no afectan a las características químico-físicas del producto. El material es impermeable al vapor, al agua, a los combustibles, a lubricantes, y presenta además una elevada resistencia química a las soluciones básicas y débilmente ácidas. Para uso profesional. | |
| Attrezzatura: spatola dentata, rullo Rapporto di catalisi: (A:B) 65:35 Diluizione: pronto uso Resa: 1,1 kg/m ² per mm di spessore Colore: incolore | | Equipment: serrated spatula, roller Mixing ration: (A:B) 65:35 Dilution: ready to use Coverage: 1,1 kg/m ² per mm of thickness Color: transparent | | Herramientas: espátula dentada, rodillo Relación de catalisis: (A:B) 65:35 Dilución: listo para usar Rendimiento: 1,1 kg/m ² per mm de espesor Color: incoloro | |

| tecniche | certificazioni | proprietà | tecnologie |
|------------------|----------------|--------------|------------|
| TROWEL ROLLER | | CARRIAGEABLE | |



acquatop fix

scheda
tecnicadata
sheetficha
técnica

| | | | | | |
|--|------------------------|---|-----------------------|---|--------------------------|
| fissativo acrilico all'acqua alta penetrazione | interno esterno | water-based acrylic fixative, excellent penetrating properties | indoor outdoor | fijador acrílico al agua de alto poder penetrante | interior exterior |
| Fissativo acrilico all'acqua a base di resine acriliche particolari, non filmogeno a particelle estremamente fini, formulato per ottenere un'alta penetrazione su rasature cementizie anche sfarinanti e per uniformare gli assorbimenti. Ideale come fissativo per applicazioni su cemento nel ciclo Acquatop. Per uso professionale. | | Water-based, non film-forming acrylic fixative containing extremely fine particles and special acrylic resins, formulated to achieve high penetration on cement-based skimming, even when chalky, and to ensure uniform absorption. Ideal as fixative for Acquatop application on cement. For professional use. | | Fijador acrílico al agua a base de resinas acrílicas particulares, no filmógeno, de partículas extremadamente finas, formulado para obtener una alta penetración en morteros de enrasado de cemento, incluso con desintegración pulverulenta, y para uniformar las absorciones. Ideal como fijador para aplicaciones en cemento en el ciclo Acquatop. Para uso profesional. | |
| Attrezzatura: pennello, rullo, airless Rapporto di catalisi: (A:B) 89:11 Diluizione: acqua - max 50% Resa (1 mano): 7-8 m ² /l - Per confezione (5 l): 60 m ² Colore: incolore | | Equipment: brush, roller, airless Mixing ration: (A:B) 89:11 Dilution: water - max 50% Coverage (1 coat): 7-8 m ² /l - Per package (5 l): 60 m ² Color: transparent | | Herramientas: brocha, rodillo, pistola pulverizadora Relación de catalisis: (A:B) 89:11 Dilución: agua - max 50% Rendimiento (1 capa): 7-8 m ² /l - Por envase (5 l): 60 m ² Color: incoloro | |

| tecniche | certificazioni | proprietà | tecnologie |
|--|----------------|-----------|------------|
|  WATER BASED  BRUSH  ROLLER  AIRLESS | | | |

acquatop primer

scheda
tecnicadata
sheetficha
técnica

| | | | | | |
|---|------------------------|---|-----------------------|---|--------------------------|
| fondo monocomponente pigmentato | interno esterno | one-pack pigmented base coat | indoor outdoor | fondo monocomponente pigmentado | interior exterior |
| Fondo monocomponente pigmentato a base di resine acriliche in dispersione acquosa, additivato con polveri di quarzo. Caratterizzato da un ottimo potere di adesione. Ideale come primer aggrappante per i supporti sotto descritti e particolarmente indicato per il ciclo Acquatop. Per uso professionale. | | Ready-to-use one-pack, pigmented acrylic resin-based base coat dispersed in water with quartz powder additives. Offers outstanding adhesion power. Ideal as primer to enhance adhesion on ceramics, bitumen sheaths, marble, stone and similar products. Particularly suitable for the Acquatop line. For professional use. | | Fondo monocomponente pigmentado a base de resinas acrílicas en dispersión acuosa, listo para usar, aditivado con polvos de cuarzo, caracterizado por un excelente poder de adhesión, ideal como imprimación activadora de adhesión para cerámica, funda bituminosa, mármol, piedra y productos similares. Particularmente adecuado para ciclo Acquatop. Para uso profesional. | |
| Attrezzatura: pennello, rullo Diluizione: pronto uso Resa (1 mano): 7-8 m ² /l - Per confezione (15 l): 120 m ² Colore: bianco | | Equipment: brush, roller Dilution: ready to use Coverage (1 coat): 7-8 m ² /l - Per package (15 l): 120 m ² Color: white | | Herramientas: brocha, rodillo Dilución: listo para usar Rendimiento (1 capa): 7-8 m ² /l - Por envase (15 l): 120 m ² Color: blanco | |

| tecniche | certificazioni | proprietà | tecnologie |
|---|----------------|-----------|------------|
|  WATER BASED  BRUSH  ROLLER  READY TO USE | | | |

acquatop cover



scheda
tecnica



data
sheet



ficha
técnica



| membrana líquida plastoelástica fibrada | interno esterno | fibre-reinforced, plasto-elastic liquid membrane | indoor outdoor | membrana líquida plastoelástica fibrada | interior exterior |
|---|----------------------------|--|---------------------------|---|------------------------------|
| Membrana líquida plastoelástica fibrada con alto poder rellentivo. Pedonable per tráfico de media intensidad. Idónea per impermeabilizar techos planos, balcones, terrazas. Su richiesta può essere formulato con pigmenti riflettenti ad alto índice de TSR, che riducono fino al 50% el riscaldamento delle superficies su cui viene aplicado. Acqua Cover colore bianco garantiza una alta reflectancia (HR). Per uso profesional. | | Fibre-reinforced, plasto-elastic liquid membrane with high filling power. Allows medium-intensity foot traffic. Suitable for waterproofing flat roofs, balconies and terraces. On request, it can be formulated with reflective, high TSR pigments, which reduce heating of the laying surfaces by up to 50%. Acqua Cover, in white color ensures high reflectance (HR). For professional use. | | Membrana líquida plastoelástica fibrada con alto poder de relleno. Admite tráfico peatonal de mediana intensidad. Idónea para impermeabilizar techos planos, balcones y terrazas. puede formularse con pigmentos reflectantes de alto índice de TSR, que reducen hasta el 50% el calentamiento de las superficies sobre las que se aplica. Acqua Cover, in white color ensures high reflectance (HR). Para uso profesional. | |
| Attrezzatura: pennello, rullo Diluizione: acqua - pronto uso Resa (3 mani): 2 kg/m ² - Per confezione (20 kg): 10 m ² Colore: rosso (S5040-Y70R) - verde (5020-G) - rosso tegola (3030-Y50R) - tortora (4010-Y50R) - grigio (4502-Y) - bianco | | Equipment: brush, roller Dilution: water - ready to use Coverage (3 mani): 2 kg/m ² - Per package (20 kg): 10 m ² Color: red (S5040-Y70R) - green (5020-G) - roofing tile red (3030-Y50R) - dove-grey (4010-Y50R) - grey (4502-Y) - white | | Herramientas: brocha, rodillo Dilución: agua - listo para usar Rendimiento (3 mani): 2 kg/m ² - Por envase (20 kg): 10 m ² Color: rojo (S5040-Y70R) - verde (5020-G) - rojo tegola (3030-Y50R) - tortora (4010-Y50R) - gris (4502-Y) - blanco | |

| tecniche | certificazioni | proprietà | tecnologie |
|----------|----------------|-----------|------------|
| | | | |

acquatop walk



scheda
tecnica



data
sheet



ficha
técnica



| rivestimento mono- componente satinato | interno esterno | one-pack, satin-finish coating | indoor outdoor | revestimiento mono- componente satinado | interior exterior |
|---|----------------------------|--|---------------------------|---|------------------------------|
| Rivestimento monocomponente satinato a base di resina acrilica in emulsione acquosa, dotato di elevata adesione, flessibilità, resistenza chimica, meccanica, all'acqua e all'abrasione. Fortemente resistente alle radiazioni UV. Particolarmente idoneo come finitura protettiva per Acquatop Cover, migliorandone la pedonabilità, grazie alla sua resistenza meccanica. Può essere formulato con pigmenti riflettenti (reflect) ad alto índice de TSR ed applicato su pavimentazioni cementizie. Permette una pedonalità per tráfico ad elevata intensità. Per uso profesional. | | One-pack, epoxy resin-based coating in aqueous emulsion. Produces a satin finish featuring high adhesion power, flexibility and superb resistance to chemicals, wear, water and abrasion. Highly resistant to UV radiation. Particularly suitable as protective topcoat for Acquatop Cover, improving walkability thanks to its mechanical resistance. Can be formulated with reflective, high TSR pigments. Allows high-intensity foot traffic. For professional use. | | Revestimiento monocomponente satinado a base de resina acrílica en emulsión acuosa, dotado de alta capacidad de adhesión, flexibilidad, resistencia química, mecánica, al agua y a la abrasión. Fuertemente resistente a las radiaciones UVA. Particolarmente idóneo como acabado protector para Acquatop Cover, mejorando su transitabilidad, gracias a su resistencia mecánica. Puede formularse con pigmentos reflectantes (reflect) de alto índice de TSR. Permite una transitabilidad para tráfico de intensidad alta. Para uso profesional. | |
| Attrezzatura: pennello, rullo, airless Diluizione: acqua - pronto uso Resa (2 mani): 2,5-3 m ² /l - Per confezione (15 l): 45 m ² Colore: rosso (S5040-Y70R) - verde (5020-G) - rosso tegola (3030-Y50R) - tortora (4010-Y50R) - grigio (4502-Y) - bianco | | Equipment: brush, roller, airless Dilution: water - ready to use Coverage (2 coats): 2,5-3 m ² /l - Per package (15 l): 45 m ² Color: red (S5040-Y70R) - green (5020-G) - roofing tile red (3030-Y50R) - dove-grey (4010-Y50R) - grey (4502-Y) - white | | Herramientas: brocha, rodillo, pistola pulverizadora Dilución: agua - listo para usar Rendimiento (2 capas): 2,5-3 m ² /l - Por envase (15 l): 45 m ² Color: rojo (S5040-Y70R) - verde (5020-G) - rojo tegola (3030-Y50R) - tortora (4010-Y50R) - gris (4502-Y) - blanco | |

| tecniche | certificazioni | proprietà | tecnologie |
|----------|----------------|-----------|------------|
| | | | |

quarzo 06



Inerte quarzifero ottenuto da sabbie selezionate a granulometria controllata atto al conferimento di maggior spessore e resistenze meccaniche.

Granulometria: 0,06-0,5 mm

Quartz-based inert derived from selected sands with controlled particle size. It imparts greater thickness and mechanical resistance.

Particle size: 0.06-0.5 mm

Cuarzo inerte obtenido a partir de arenas seleccionadas con granulometria controlada diseñado para dar mayor espesor y resistencia mecánica.

Granulometria: 0,06-0,5 mm

quarzo 04



Inerte quarzifero ottenuto da sabbie selezionate a granulometria controllata atto al conferimento di maggior spessore e resistenze meccaniche.

Granulometria: 0,1-1,5 mm

Quartz-based inert derived from selected sands with controlled particle size. It imparts greater thickness and mechanical resistance.

Particle size: 0,1-1,5 mm

Cuarzo inerte obtenido a partir de arenas seleccionadas con granulometria controlada diseñado para dar mayor espesor y resistencia mecánica.

Granulometria: 0,1-1,5 mm

quarzo 02



Inerte quarzifero ottenuto da sabbie selezionate a granulometria controllata atto al conferimento di maggior spessore e resistenze meccaniche.

Granulometria: 0,3-0,9 mm

Quartz-based inert derived from selected sands with controlled particle size. It imparts greater thickness and mechanical resistance.

Particle size: 0,3-0,9 mm

Cuarzo inerte obtenido a partir de arenas seleccionadas con granulometria controlada diseñado para dar mayor espesor y resistencia mecánica.

Granulometria: 0,3-0,9 mm

corindone bianco



Carica in polvere per Epoplast, per conferire alla pavimentazione un effetto decorativo e di maggior resistenza superficiale

Powder extender for Epoplast. It gives the flooring a decorative look and greater surface resistance.

Masilla en polvo para Epoplast, para dar al pavimento un efecto decorativo y una mayor resistencia superficial

corindone bruno



Carica in polvere per Epoplast, per conferire alla pavimentazione un effetto decorativo e di maggior resistenza superficiale

Powder extender for Epoplast. It gives the flooring a decorative look and greater surface resistance.

Masilla en polvo para Epoplast, para dar al pavimento un efecto decorativo y una mayor resistencia superficial

aerosil 200



Silicie addensante per sistemi resinosi

Silica-based thickener for resinous systems.

Espesante de silicio para sistemas de resinas

microfibra 80



Additivo per resine epossidiche e poliuretanniche, per finiture antiskid

Additive for epoxy and polyurethane resins, for antiskid finishes.

Aditivo para resinas epoxi y poliuretano, para acabados antideslizantes

cips colorate



Cariche decorative per Epoplast

Decorative extenders for Epoplast.

Cariche decorativas para Epoplast

perline vetro



Additivo per resine epossidiche e poliuretanniche, per finiture antiskid

Additive for epoxy and polyurethane resins, for antiskid finishes.

Aditivo para resinas epoxi y poliuretano, para acabados antiskid

polybeton ls

 scheda
tecnica

 data
sheet

 ficha
técnica

| rivestimento elastico bicomponente poliuretano | interno esterno | elastic, polyurethane coating | indoor outdoor | Revestimiento elástico poliuretánico | interior exterior |
|---|-----------------|---|----------------|--|-------------------|
| Rivestimento autolivellante elastico bicomponente poliuretano per la realizzazione di malte autolivellanti elastoplastiche pedonabili, utilizzabile anche a rullo come rivestimento a basso spessore elastico. Spessori consigliati fino a 3 mm. Colorato, indicato per pavimenti soggetti a carichi pesanti e sollecitazioni meccaniche e chimiche. Per uso professionale. | | Two-pack elastic, polyurethane coating for the production of elastic-plastic self-levelling mortars that can be walked on; can also be applied by roller as a coating with low elastic thickness. Recommended thickness: up to 3 mm. Coloured, suitable for floors subject to heavy loads and mechanical and chemical stresses. For professional use. | | Revestimiento autonivelante elástico bicomponente poliuretánico para la realización de morteros autonivelantes elastoplásticos válidos para tránsito peatonal, utilizable también con rodillo como revestimiento de bajo espesor elástico. Espesores aconsejados hasta 3 mm. De color, indicado para suelos sujetos a cargas pesadas y esfuerzos mecánicos y químicos. Para uso profesional. | |
| Attrezzatura: spatola dentata, rullo frangibolle Rapporto di catalisi: (A:B:C) 2,74:2,22:11,5 Diluizione: pronto uso Resa: 2 kg/m ² per mm di spessore Colore: colorato | | Equipment: serrated spatula, bubble-buster roller Mixing ratio: (A:B:C) 2,74:2,22:11,5 Dilution: ready to use Coverage: 2 kg/m ² per mm of thickness Color: colored | | Herramientas: Espátula dentada y rodillo antiburbujas para aplicación de espesor Relación de catálisis: (A:B:C) 2,74:2,22:11,5 Dilución: listo para usar Rendimiento: 2 kg/m ² per mm de espesor Color: colorido | |

| tecniche | certificazioni | proprietà | tecnologie |
|-----------------------------------|----------------|-----------|------------|
| SOLVENT BASED TROWEL ROLLER | | WALKABLE | |

polybeton ht

 scheda
tecnica

 data
sheet

 ficha
técnica

| rivestimento elastico tricomponente poliuretano | interno esterno | two-pack, elastic, polyurethane coating | indoor outdoor | revestimiento elástico bicomponente poliuretánico | interior exterior |
|---|-----------------|---|----------------|--|-------------------|
| Rivestimento autolivellante elastico tricomponente poliuretano per la realizzazione di malte autolivellanti elastoplastiche pedonabili, utilizzabile anche a rullo come rivestimento spessore consigliato 6/7 mm elastico. Colorato, indicato per pavimenti soggetti a carichi pesanti e sollecitazioni meccaniche e chimiche. Per uso professionale. | | Two-pack elastic, polyurethane coating for the production of elastic-plastic self-levelling mortars that can be walked on; it can also be applied by roller, recommended thickness 6/7 mm. Coloured, suitable for floors subject to heavy loads and mechanical and chemical stresses. For professional use. | | Revestimiento autonivelante elástico bicomponente poliuretánico para la realización de morteros autonivelantes elastoplásticos válidos para tránsito peatonal, utilizable también con rodillo como revestimiento, espesor recomendado 6/7mm. De color, indicado para suelos sujetos a cargas pesadas y esfuerzos mecánicos y químicos. Para uso profesional. | |
| Attrezzatura: spatola dentata, rullo frangibolle Rapporto di catalisi: (A:B:C) 2,74:2,22:23 Diluizione: pronto uso Resa: 2 kg/m ² per mm di spessore Colore: colorato | | Equipment: serrated spatula, bubble-buster roller Mixing ratio: (A:B:C) 2,74:2,22:23 Dilution: ready to use Coverage: 2 kg/m ² per mm of thickness Color: colored | | Herramientas: espátula dentada y rodillo antiburbujas para aplicación de espesor Proporción de mezcla: (A:B:C) 2,74:2,22:23 Dilución: listo para usar Rendimiento: 2 kg/m ² per mm de espesor Color: colorido | |

| tecniche | certificazioni | proprietà | tecnologie |
|-----------------------------------|----------------|-----------|------------|
| SOLVENT BASED TROWEL ROLLER | | WALKABLE | |

polyfast p



scheda
tecnica



data
sheet



ficha
técnica

| rivestimento elastico poliuretano | interno esterno | elastic polyurethane coating | indoor outdoor | revestimiento elástico poliuretánico | interior exterior |
|---|------------------------|---|-----------------------|---|--------------------------|
| Rivestimento elastico, a base di resine poliureiche. Formulato con isocianati aromatici e particolari diammine a diversificato peso molecolare. Per la sua elevata resistenza è adatto anche per impermeabilizzazione di parcheggi auto. Per uso professionale. | | Elastic coating, based on polyurea resins. Formulated with aromatic isocyanates and particular diamines of different molecular weights. Due to its high resistance it is also suitable for waterproofing car parks. For professional use. | | Revestimiento elástico, a base de resinas poliureicas. Formulada con isocianatos aromaticos y diaminas especificas de distintos pesos moleculares. Por su alta resistencia también es adecuado para la impermeabilización de aparcamientos. Para uso profesional. | |
| Attrezzatura: airless tipo bi-mixer ad alta pressione Rapporto di catalisi: (A:B) 50:50 Diluizione: pronto uso Resa: 1 kg/m ² per mm di spessore Colore: incolore | | Equipment: high pressure airless, bi-mixer type Mixing ration: (A:B) 50:50 Dilution: ready to use Coverage: 1 kg/m ² per mm of thickness Color: transparent | | Herramientas: Pistola pulverizadora tipo bi-mixer de alta presión Relación de catalisis: (A:B) 50:50 Dilución: listo para usar Rendimiento: 1 kg/m ² per mm de espesor Color: incoloro | |

| tecniche | | | certificazioni | | | proprietà | | | tecnologie | | |
|----------|--|--|----------------|--|--|-----------|--|--|------------|--|--|
| | | | | | | | | | | | |

polyfast ib



scheda
tecnica



data
sheet



ficha
técnica

| rivestimento elastico poliuretano | esterno | elastic polyurethane coating | outdoor | revestimiento elástico poliuretánico | exterior |
|---|----------------|---|----------------|---|-----------------|
| Rivestimento bicomponente elastico, a base di resine poliureiche. Poliurea formulata con isocianati aromatici e particolari diammine a diversificato peso molecolare. Per uso professionale. | | Elastic coating, based on polyurea resins formulated with aromatic isocyanates and particular diamines of different molecular weights. For professional use. | | Revestimiento bicomponente elástico, a base de resinas poliureicas formulada con isocianatos aromaticos y diaminas especificas de distintos pesos moleculares. Para uso profesional. | |
| Attrezzatura: airless tipo bi-mixer ad alta pressione Rapporto di catalisi: (A:B) 50:50 Diluizione: pronto uso Resa: 1 kg/m ² per mm di spessore Colore: incolore | | Equipment: high pressure airless, bi-mixer type Mixing ration: (A:B) 50:50 Dilution: ready to use Coverage: 1 kg/m ² per mm of thickness Color: transparent | | Herramientas: Pistola pulverizadora tipo bi-mixer de alta presión Proporción de mezcla: (A:B) 50:50 Dilución: listo para usar Rendimiento: 1 kg/m ² per mm de espesor Color: incoloro | |

| tecniche | | | certificazioni | | | proprietà | | | tecnologie | | |
|----------|--|--|----------------|--|--|-----------|--|--|------------|--|--|
| | | | | | | | | | | | |

bandella di rame



Reticolo in rame per ciclo autolivellante antistatico

Mesh of copper strips for antistatic self-levelling applications

Rejilla de cobre para ciclo autonivelante antiestático

Dimensioni rotolo: 10 mm x 16,5 m

Roll size: 10 mm x 16,5 m

Tamaño de rollo: 10 mm x 16,5 m

tessuto di vetro



Rete tessuta in fibra di vetro per l'armatura delle rasature epossidiche, all'interno ed all'esterno.

Glass fibre mesh to reinforce epoxy skim coats. For interior and exterior

Malla tejida de fibra de vidrio para el refuerzo del alisado epoxi, tanto en el interior como en el exterior.

Peso: 80 g/m²

Weight: 80 g/m²

Peso: 80 g/m²



scheda
tecnica



data
sheet



ficha
técnica





IL NETWORK DEL COLORE SU MISURA

you
sistema tir

linee prodotti

macchine tintometriche

accessori

coloranti concentrati

prodotti a tintometro

u color
ntometrico

tintometro manuale



| 12 o 20 canestri | 12 o 20 canisters | 12 o 20 botes |
|---|---|--|
| <ul style="list-style-type: none"> ▶ Manuale ▶ Ideale per coloranti all'acqua e a solvente ▶ Ergonomico e funzionale ▶ Maneggevole durante il dosaggio ▶ Facile da utilizzare, anche per operatori inesperti ▶ Canestri resistenti in poli ossido metilene ▶ Valvole in ceramica resistenti all'abrasione ▶ Sistema antigocciolamento automatico (mantiene pulita l'area di lavoro) | <ul style="list-style-type: none"> ▶ Manual ▶ Ideal for water and solvent based colourants ▶ Ergonomic and functional ▶ Easy to use during dosage ▶ Easy to use, also for inexperienced operators ▶ Resistant canisters in poly ethylene oxide ▶ Abrasion-resistant ceramic valves ▶ Automatic anti-drip system (keeps the work area clean) | <ul style="list-style-type: none"> ▶ Manual ▶ Ideal para tintes a base de agua y solventes ▶ Ergonómico y funcional ▶ Práctico durante la dosificación ▶ Fácil de usar, incluso para operadores sin experiencia ▶ Cestas de polioxido de metileno resistentes ▶ Válvulas de cerámica resistentes a la abrasión ▶ Sistema automático antigoteo (mantiene limpia el área de trabajo) |
| Numero Canestri: 12 o 20 Settore di produzione: acqua e solvente. Ideale per rivendite medio-piccole con produzione non continuativa Dimensioni: 121x110 cm | Number of canisters: 12 o 20 Production sector: water and solvent. Ideal for medium-small retail with non-continuous production Dimensions: 121x110 cm | Numero de botes: 12 o 20 Sector productivo: agua y solvente Ideal para reventas pequeñas y medianas con producción discontinua Medidas: 121x110 cm |

tintometro a4b



| 24 canestri | 24 canisters | 24 botes |
|---|--|---|
| <ul style="list-style-type: none"> ▶ Automatico Sequenziale ▶ Dotato di piano girevole, a 24 canestri ▶ Elettronica semplificata di ultima generazione ▶ Altezza di soli 1,3 m (quindi facile da utilizzare) ▶ Facilità di riempimento dei coloranti ▶ Facile accesso a tutti i controlli ▶ Compreso di braccio di supporto per monitor computer ▶ Compreso software Datacolor Paint EFB ▶ Sgabello elevatore per latta automatico ▶ Non richiede spurgo giornaliero degli ugelli | <ul style="list-style-type: none"> ▶ Automatic sequential dispensing ▶ With two-way turntable, 24 canisters ▶ Latest generation of simplified electronics ▶ Height only 1.3 m (easy to use) ▶ Easy refilling of dyes ▶ Easy access to all controls ▶ Support arm for PC monitor included ▶ Software Datacolor Paint EFB included ▶ Automatic can lift ▶ nozzle cleaning not required daily | <ul style="list-style-type: none"> ▶ Secuencial automático ▶ Equipado con tapa giratoria, con 24 cestas ▶ Electrónica simplificada de última generación ▶ Altura de solo 1,3m (por lo tanto, fácil de usar) ▶ Fácil llenado de tintes ▶ Fácil acceso a todos los controles ▶ Incluye brazo de soporte para monitor de computadora ▶ Incluye el software Datacolor Paint EFB ▶ Taburete elevador para estaño automático ▶ No requiere sangrado diario de las boquillas |
| Numero Canestri: 24 Settore di produzione: acqua Ideale per negozi e centri del colore di medie dimensioni con produzione media di 20-30 confezioni al giorno Dimensioni: 90x100x133,5 cm | Number of canisters: 24 Production sector: water Ideal for medium sized retail and paint shops with an average production of 20-30 containers a day. Dimensions: 90x100x133.5 cm | Numero de botes: 24 Sector productivo: agua Ideal para medianas tiendas y centros de la Gama de colores con una producción media de 20-30 envases por día Medidas: 90x100x133,5 cm |

tintometro elettronico d300



| 20 canestri | 20 canisters | 20 botes |
|--|--|---|
| <ul style="list-style-type: none"> ▶ Automatico Simultaneo ▶ Nuova tecnologia di pompaggio a pistone brevettata ▶ Ottimo rapporto qualità-quantità/prezzo ▶ Bassi costi di manutenzione ▶ Altezza di soli 1,3 m (quindi facile da utilizzare) ▶ Alta velocità di erogazione ▶ Sistema brevettato di umidificazione automatico ▶ Ridotta possibilità di essiccazione del colorante ▶ Configurabile con canestri di 4 o 6 litri | <ul style="list-style-type: none"> ▶ Automatic simultaneous dispensing ▶ New patented piston pump technology ▶ Excellent quality-quantity / price ratio ▶ Low maintenance costs ▶ Height only 1.3 m (easy to use) ▶ High speed dispensing ▶ Patented automatic humidification system ▶ Reduced possibility of drying of dyes ▶ Set up with 4 or 6 litre canisters | <ul style="list-style-type: none"> ▶ Automático simultáneo ▶ Nueva tecnología de bombeo de pistón patentada ▶ Excelente relación calidad-cantidad / precio ▶ Bajos costos de mantenimiento ▶ Altura de solo 1,3 m (por lo tanto, fácil de usar) ▶ Alta velocidad de dispensación ▶ Sistema de humidificación automático patentado ▶ Posibilidad reducida de secado del tinte ▶ Configurable con bidones de 4 o 6 litros ▶ Incluye el software Datacolor Paint Color Cardmatch |
| <p>Numero Canestri: 20 Settore di produzione: acqua Ideale per negozi e centri del colore di medie dimensioni con produzione di 30/50 confezioni al giorno Dimensioni: 102x94x136 cm</p> | <p>Number of canisters: 20 Production sector: water Ideal for medium sized retail and paint shops with a production of 30/50 containers a day Dimensions: 102x94x136 cm</p> | <p>Numero de botes: 20 Sector productivo: agua Ideal para medianas tiendas y centros de la Gama de colores con producción de 30/50 paquetes por día Dimensiones: 102x94x136 cm</p> |

tintometro ha480



| 20 canestri | 20 canisters | 20 botes |
|--|---|--|
| <ul style="list-style-type: none"> ▶ Automatico Sequenziale ▶ Performante e affidabile ▶ Design di qualità ▶ Zero spreco di colorante ▶ Manutenzione minima ▶ Un dispensatore sempre pronto ▶ Pompa a pistone per svuotamento autonomo ▶ Compreso software Datacolor Paint Color Cardmatch ▶ Non richiede spurgo giornaliero degli ugelli | <ul style="list-style-type: none"> ▶ Automatic sequential dispensing ▶ High performance and trustworthy ▶ Quality design ▶ Zero waste of colourants ▶ Minimal maintenance ▶ Dispenser always ready ▶ Piston pump for automatic emptying ▶ Software Datacolor Paint Color Cardmatch included ▶ Nozzle cleaning not required daily | <ul style="list-style-type: none"> ▶ Secuencial automático ▶ Desempeño y confiable ▶ Diseño de calidad ▶ Cero desperdicio de tinte ▶ Mantenimiento mínimo ▶ Un dispensador siempre listo ▶ Bomba de pistón para vaciado autónomo ▶ Incluye el software Datacolor Paint Color Cardmatch ▶ No requiere sangrado diario de las boquillas |
| <p>Numero Canestri: 20 Settore di produzione: acqua e solvente Ideale per centri bricolage, depositi, colorifici, punti vendita di medio-grandi dimensioni con produzione di oltre 50 confezioni al giorno. Ideale per coprire l'intera gamma prodotti lvas Dimensioni: 88x96x151 cm</p> | <p>Number of canisters: 20 Production sector: water and solvent Ideal for medium-large sized DIY outlets, retailers, paint shops, points of sale with a production of over 50 containers a day. Ideal to cover the complete lvas range of products Dimensions: 88x96x151 cm</p> | <p>Numero de botes: 20 Sector productivo: agua y solvente Ideal para centros de bricolaje, almacenes, talleres de pintura, tiendas de tamaño mediano-grande con producción de más de 50 paquetes por día. Ideal para cubrir toda la gama de productos lvas Dimensiones: 88x96x151 cm</p> |

tintometro d600 minimodula



| elettronico simultaneo a 20 canestri | simultaneous electronic 20 canisters | electrónico simultáneo a 20 botes |
|--|---|---|
| <ul style="list-style-type: none"> ▶ Automatico Simultaneo ▶ Testata interna ▶ Modula con testa di erogazione espandibile fino a 20 ugelli ▶ Estetica compatta ▶ Massima ergonomia e funzionalità ▶ Sistema Autocap che evita l'essiccazione del colorante ▶ Elettronica di ultima generazione ▶ Dispensazione veloce, precisa e ripetibile ▶ Compreso software Datacolor Paint Color Cardmatch | <ul style="list-style-type: none"> ▶ Automatic simultaneous dispensing ▶ Internal Head ▶ Module with dispensing head expandable up to 20 nozzles ▶ Compact design ▶ Maximum flow and workability ▶ Autocap System to avoid drying of dyes ▶ Electronics of latest generation ▶ Fast, precise and repeatable dispensing ▶ Software Datacolor Paint Color Cardmatch included | <ul style="list-style-type: none"> ▶ Automático simultáneo ▶ Módulo con cabezal de salida ampliable hasta 20 boquillas ▶ Estética compacta ▶ Máxima ergonomía y funcionalidad ▶ Sistema Autocap que evita que el tinte se seque ▶ Electrónica de última generación ▶ Dispensación rápida, precisa y repetible ▶ Incluye el software Datacolor Paint Color Cardmatch |
| <p>Numero Canestri: 20 Settore di produzione: acqua Ideale per centri bricolage, depositi, colorifici, punti vendita di medio-grandi dimensioni con produzione di oltre 50 confezioni al giorno Ideale per coprire l'intera gamma prodotti lvas all'acqua Dimensioni: 140x88x119 cm</p> | <p>Number of canisters: 20 Production sector: water Ideal for medium-large sized DIY outlets, retailers, paint shops and points of sale with production of over 50 containers a day. Ideal to cover the complete lvas water-based range of products Dimensions: 140x88x119 cm</p> | <p>Numero de botes: 20 Sector productivo: agua Ideal para centros de bricolaje, almacenes, talleres de pintura, tiendas de tamaño mediano-grande con producción de más de 50 paquetes por día. Ideal para cubrir toda la gama de productos lvas all'agua Medidas: 140x88x119 cm</p> |

tintometro elettronico d700



| 20 canestri testata esterna | external head 20 canisters | 20 botas cabecera exterior |
|---|---|---|
| <ul style="list-style-type: none"> ▶ Automatico Simultaneo ▶ Testata esterna ▶ Top di gamma tra le macchine tintometriche sul mercato ▶ Performance ottimizzata al più alto livello ▶ Massima velocità di erogazione ▶ Sistema Autocap che evita l'essiccazione del colorante ▶ Precisione e ripetibilità delle tinte estremamente elevate ▶ Modula con testa di erogazione a 20 ugelli ▶ Pompe ad ingranaggi ▶ Tecnologia di ultima generazione ▶ Estetica compatta ▶ Massima varietà di tinte erogabili | <ul style="list-style-type: none"> ▶ Automatic simultaneous dispensing ▶ External head ▶ Top of the range of tinting machines on the market ▶ Optimized performance at the highest level ▶ Maximum flow speed ▶ Autocap system to avoid drying of dyes ▶ Precision and extremely high colour reproduction ▶ Module with dispensing head 20 nozzles ▶ Gear pump technology ▶ Latest generation technology ▶ Compact design Massima varietà di tinte erogabili | <ul style="list-style-type: none"> ▶ Automático simultáneo ▶ Top de gama entre las máquinas de tintado del mercado ▶ Rendimiento optimizado al más alto nivel ▶ Velocidad máxima de dispensación ▶ Sistema Autocap que evita que el tinte se seque ▶ Precisión y repetibilidad de colores extremadamente altas ▶ Módulo con cabezal dispensador de 20 boquillas ▶ Bombas de engranajes ▶ Tecnología de última generación ▶ Estética compacta ▶ Máxima variedad de colores que se pueden dispensar ▶ Incluye el software Datacolor Paint Color Cardmatch ▶ Incluyendo 3 transportadores de rodillos |
| <p>Numero Canestri: 20 Settore di produzione: acqua Ideale per centri professionali di grandi dimensioni, alta specializzazione con produzione oltre le 100 confezioni al giorno. Ideale per coprire l'intera gamma prodotti lvas Dimensioni: 181x110x120 cm</p> | <p>Number of canisters: 20 Production sector: water Ideal for large sized professional centres, highly specialised with a production of over 100 containers a day. Ideal to cover the complete lvas range of products Dimensions: 181x110x120 cm</p> | <p>Numero de botes: 20 Sector productivo: agua Ideal para grandes centros profesionales, altamente especializados con producción superior a 100 envases al día. Ideal para cubrir toda la gama de productos lvas Medidas: 181x110x120 cm</p> |

tintometro elettronico d700



| 32 canestri testata esterna | external head 32 canisters | 32 botas cabecera exterior |
|---|---|---|
| <ul style="list-style-type: none"> ▶ Automatico Simultaneo ▶ Testata esterna ▶ Top di gamma tra le macchine tintometriche sul mercato ▶ Performance ottimizzata al più alto livello ▶ Massima velocità di erogazione ▶ Precisione e ripetibilità delle tinte estremamente elevate ▶ Modula con testa di erogazione a 32 ugelli ▶ Pompe ad ingranaggi ▶ Tecnologia di ultima generazione ▶ Estetica compatta ▶ Massima varietà di tinte erogabili | <ul style="list-style-type: none"> ▶ Automatic simultaneous dispensing ▶ External head ▶ Top of the range tinting machines on the market ▶ Optimized performance at the highest level ▶ Maximum flow speed ▶ Precision and extremely high colour reproduction ▶ Module with dispensing head 32 nozzles ▶ Gear pump technology ▶ Latest generation technology ▶ Compact design ▶ Maximum variety of dispensed colours | <ul style="list-style-type: none"> ▶ Automático simultáneo ▶ Top de gama entre las máquinas de tinado del mercado ▶ Rendimiento optimizado al más alto nivel ▶ Velocidad máxima de dispensación ▶ Precisión y repetibilidad de colores extremadamente altas ▶ Modula con cabezal dispensador de 32 boquillas ▶ Bombas de engranajes ▶ Tecnología de última generación ▶ Estética compacta ▶ Máxima variedad de colores que se pueden dispensar ▶ Incluye el software Datacolor Paint Color Cardmatch ▶ Incluyendo 4 transportadores de rodillos |
| <p>Numero Canestri: 32</p> <p>Settore di produzione: acqua e solvente. Ideale per centri professionali di grandi dimensioni, alta specializzazione con produzione oltre le 100 confezioni al giorno. Ideale per coprire l'intera gamma prodotti Ivas</p> <p>Dimensioni: 222x110x120 cm</p> | <p>Number of canisters: 32</p> <p>Production sector: water e solvent Ideal for large sized professional centres, highly specialised with a production of over 100 containers a day. Ideal to cover the complete Ivas range of products</p> <p>Dimensions: 222x110x120 cm</p> | <p>Numero de botes: 32</p> <p>Sector productivo: agua y solvente Ideal para grandes centros profesionales, altamente especializados con producción superior a 100 envases al día. Ideal para cubrir toda la gama de productos Ivas</p> <p>Dimensiones: 222x110x120 cm</p> |

mixer glos



Agitatore a colonna professionale che viene posizionato direttamente sul fianco del tintometro per la miscelazione in linea e che permette una miscelazione a bassa velocità senza alterare la struttura di rivestimenti, quarzi lavabili, ecc.

Professional column mixer placed directly at the side of the tinting machine for in-line mixing, allowing low speed mixing without altering the structure of paints, washable quartz, etc.

Agitador de columna profesional que se coloca directamente en el lateral del tintómetro para mezclar en línea y que permite mezclar a baja velocidad sin alterar la estructura de recubrimientos, cuarzo lavable, etc.

agitatore manuale giroscopico



Agitatore manuale Giroscopico con porta tri-direzionale a scorrimento interno. Chiusura manuale.

Capacità di carico: 40 kg
Dimensioni: 83x93x117,5 cm

Manual gyroscope mixer with three-directional sliding door. Manual closure.

Weight capacity: 40 kg
Dimensions: 83x93x117,5 cm

Agitador manual Giroscopio con puerta tri-direccional de deslizamiento interno. Cierre manual.

Capacità di carico: 40 kg
Medidas: 83x93x117,5 cm

agitatore elettronico giroscopico



L'Agitatore Elettronico Giroscopico è un miscelatore automatico a 3 velocità. Idoneo alla miscelazione di tutti i tipi di vernice per esterni ed interni.

Testata interna
Piatto di carico: estraibile
Capacità di carico: 40 kg (h. fino a 49 cm)
Diametro massimo del contenitore: 38 cm
Dimensioni: 104x86x80 cm

The electronic gyroscope stirrer is an automatic 3-speed mixer. Suitable for mixing all types of paint for exterior and interior use.

Internal head
Loaded plate: removable
Load capacity: 40 kg (h. to 49 cm)
Maximum diameter of the container: 38 cm
Dimensions: 100x88x102 cm

El agitador electrónico giroscópico es un mezclador biaxial automático de 3 velocidades. Apto para mezclar todo tipo de pintura para exterior e interior.

Cabeza interna
Capacidad de carga: 40 kg (h. hasta 49 cm)
Diámetro máximo del recipiente: 38 cm.
Medidas: 104x86x80 cm.

software datacolor paint efb

Livello 1: Gestione formule delle collezioni IVAS e dei codici colori internazionali (NCS Index, RAL Design e RAL Classic)

Level 1: Formula management of the IVAS collections and international colour codes (NCS Index, RAL Design e RAL Classic)

Nivel 1: Gestión de fórmulas de colecciones IVAS y códigos de colores internacionales (NCS Index, RAL Design y RAL Classic)

software datacolor paint color cardmatch

Livello 1: Gestione formule delle collezioni IVAS e dei codici colori internazionali (NCS Index, RAL Design e RAL Classic)

Livello 2: Oltre al livello 1, grazie alle caratterizzazioni colore personalizzate IVAS ed al motore di calcolo presente nel software aggiunge la possibilità di formulare tutte le tinte delle cartelle colore presenti sul mercato.

Level 1: Formula management of the IVAS collections and international colour codes (NCS Index, RAL Design e RAL Classic)

Level 2: In addition to level 1, thanks to the composition of the customised IVAS colours and the calculation engine in the software, there is the added possibility to formulate all the colours of the colour cards on the market.

Nivel 1: Gestión de fórmulas de colecciones IVAS y códigos de colores internacionales (NCS Index, RAL Design y RAL Classic)

Nivel 2: Además del nivel 1, gracias a las características de colores personalizados de IVAS y al motor de cálculo presente en el software, agrega la posibilidad de formular todos los colores de las gamas de colores del mercado.

software per spettrofotometro

Livello 1: Gestione formule delle collezioni IVAS e dei codici colori internazionali (NCS Index, RAL Design e RAL Classic)

Livello 2: Grazie alle caratterizzazioni colore personalizzate IVAS ed al motore di calcolo presente nel software aggiunge la possibilità di formulare tutte le tinte delle cartelle colore presenti sul mercato

Livello 3: Oltre al livello 1 e 2, attraverso l'utilizzo dello spettrofotometro Datacolor D20 aggiunge la possibilità di caratterizzare ed erogare istantaneamente qualsiasi campione colore del cliente.

Level 1: Formula management of the IVAS collections and international colour codes (NCS Index, RAL Design e RAL Classic)

Level 2: In addition to level 1, thanks to the composition of the customised IVAS colours and the calculation engine in the software, there is the added possibility to instantly formulate and dispense any customer colour sample.

Level 3: In addition to level 1 and 2, by using the Datacolor D20 spectrophotometer you have the possibility to

Nivel 1: Gestión de fórmulas de colecciones IVAS y códigos de colores internacionales (NCS Index, RAL Design y RAL Classic)

Nivel 2: Además del nivel 1, gracias a las características de colores personalizados de IVAS y al motor de cálculo presente en el software, agrega la posibilidad de formular todos los colores de las gamas de colores del mercado.

Nivel 3: Además de los niveles 1 y 2, mediante el uso del espectrofotómetro Datacolor D20 agrega la posibilidad de caracterizar y dispensar instantáneamente la muestra de Gama de colores de cualquier cliente.

spettrofotometro datacolor d20



La geometria a sfera di Datacolor D20 consente una misura precisa del colore su campioni lisci e con rilievi. La determinazione della lucentezza del campione, combinata con la compensazione della lucentezza nel software, consente una formulazione del colore visivamente perfetta. Lo strumento portatile consente di misurare qualsiasi campione in qualsiasi luogo, nel punto vendita o presso la sede di lavoro del vostro cliente.

Peso: 1,25 kg
Dimensioni: 9,9x9x23,5 cm
Display: LCD 240x320

The sphere geometry of Datacolor D20 allows precise colour measurement on smooth and textured samples. The characterisation of the gloss of the sample, combined with the gloss compensation in the software, allows a visually perfect colour formulation.

The portable tool allows you to measure samples anywhere, at the point of sale or at the customers' workplace.

Weight: 1,25 kg
Dimensions: 9,9x9x23,5 cm
Display: LCD 240x320

La geometria di bola de Datacolor D20 permite una medición precisa del color sobre muestras lisas y con relieves. La determinación del brillo de la muestra, combinada con la compensación del brillo en el software, permite una formulación de color visualmente perfecta.

El instrumento portátil permite medir cualquier muestra en cualquier lugar, en el punto de venta o en el lugar de trabajo de su cliente.

Peso: 1,25 kg
Dimensiones: 9,9x9x23,5 cm
Display: LCD 240x320

color reader



Dispositivo di selezione dei colori ultra-portatile, per una migliore affidabilità nella lettura del colore.

Presenta una corrispondenza leader del settore con un successo superiore al 95% sui campionari di colori più diffusi, (oltre 10.000 colori) trovando in pochi secondi il colore più somigliante

L'app mobile ColorReader fornisce tutto ciò che serve ai decoratori per individuare i colori corrispondenti, lavorare con i campionari di colori, creare e condividere le tavolozze sullo smartphone iPhone® o Android™.

Diametro: 30,22 mm
Lunghezza: 108,8 mm
Peso: 61,5 grammi
Contenuto della confezione: Dispositivo ColorReaderPRO, borsa per il trasporto, cavo Micro USB, diapositiva di calibrazione, scheda di benvenuto

Portable colour matching tool, to better identify the colors of paints.

leading in this sector, its success' rate is above 95% for the most common colour samples (over 10.000) finding the most similar colour in just few seconds.

The ColorReader mobile app provides everything that decorators need in order to find the matching colours, work with colour samples, create and share palettes on iPhone® or Android™ smartphone.

Diameter: 30,22 mm
Length: 108,8 mm
Weight: 61,5 grams
Package contents: ColorReaderPRO device, carrying bag, Micro USB cable, calibration slide, welcome card

Dispositivo de selección de color ultraportátil, para mayor confiabilidad en la lectura de la Gama de colores.

Presenta una correspondencia líder en la industria con un éxito de más del 95% en las muestras de color más populares (más de 10,000 colores), encontrando los Gama de colores más similares en segundos.

La aplicación móvil ColorReader proporciona todo lo que los decoradores necesitan para identificar colores coincidentes, trabajar con muestras de color, crear y compartir paletas en el teléfono inteligente iPhone® o Android™.

Diámetro: 30,22 mm
Longitud: 108,8 mm
Peso: 61,5 grammi
Contenido de la caja: dispositivo ColorReaderPRO, bolsa de transporte, cable micro USB, diapositiva de calibración, tarjeta de bienvenida

stampante dymo label writer 550



Design innovativo

Velocità di stampa: 62 etichette al minuto. Back-up automatico della prima etichetta
Connessione USB

Advanced design

Print speed: 62 labels per minute. Automatic back-up of the first label
USB connection

Design innovativo

Velocidad de impresión: 62 etiquetas por minuto. Copia de seguridad automática de la primera etiqueta
Conexión USB

coloranti concentrati rie per prodotti all'acqua

 scheda
tecnica

 data
sheet

 ficha
técnica

| | interno esterno | | indoor outdoor | | interior exterior |
|--|---|--|---|--|--|
| | ** non utilizzabili per prodotti alla calce | | ** cannot be used with lime-based product | | ** no utilizable para productos de cal |

coloranti concentrati ri per prodotti all'acqua

 scheda
tecnica

 data
sheet

 ficha
técnica

| | interno | | indoor | | interiores |
|--|---------|--|--------|--|------------|
| | | | | | |

coloranti concentrati rie per prodotti al solvente

 scheda
tecnica

 data
sheet

 ficha
técnica

| | interno esterno | | indoor outdoor | | interior exterior |
|--|---|--|---|--|--|
| | ** non utilizzabili per prodotti alla calce | | ** cannot be used with lime-based product | | ** no utilizable para productos de cal |

coloranti concentrati ri per prodotti al solvente

 scheda
tecnica

 data
sheet

 ficha
técnica

| | interno | | indoor | | interiores |
|--|---------|--|--------|--|------------|
| | | | | | |

youcolor

prodotti a tintometro - products colourable with tinting machines - productos al tintómetro

Il sistema tintometrico IVAS è composto da macchine tintometriche, software e paste coloranti (Coloranti Concentrati IVAS) che permettono l'erogazione di oltre 100.000 formulazioni colore.

I prodotti colorabili con sistemi tintometrici IVAS, nelle tinte indicate nel dettaglio di ogni singolo prodotto, sono i seguenti:

The IVAS tinting machine systems are comprised of tinting machines, software and paste colourants (Coloranti Concentrati IVAS) that enable the dispensing of over 100,000 colour formulations.

The products that can be coloured with the IVAS tinting machine, in the colours indicated in detail of each single product, are as follows:

Los sistemas de tintado IVAS están compuestos por máquinas de tintado, software y pastas colorantes (Colorantes concentrados IVAS) que permiten la dispensación de más de 100.000 formulaciones de Gama de colores. Los productos que se pueden colorear con los sistemas de tintado IVAS, en los colores indicados en el detalle de cada producto individual, son los siguientes:

| | |
|--------------------|--------------------------------|
| best seller | enjoy 1 coat |
| idrosmalti | idromatt |
| | idrosatin |
| | idrogloss |
| lavabili | clean matt |
| | luxury |
| | tech active |
| | sol-tex |
| idropitture | silan tech |
| | traspinterno |
| | mural verde |
| vita sana | vita wash |
| | sana bianca |
| | sanasil-bio |
| paint ht | silox plus |
| | superquarz plus |
| | ultra dry |
| | superclean plus |
| | superquarz plus strong |
| | ivasgum side finitura |
| | quarzogum plus |
| | idrobeton |
| | ivasil pittura |
| | deco sand plus |
| | ivaglass lucido |
| | ivaglass opaco |
| exterior ht | intonachino idrosiliconico g08 |
| | intonachino idrosiliconico g06 |
| | rivasil g15 |
| | rivasil g12 |

| | | |
|--------------------------|----------------------------------|------------------|
| exterior | finquarz | |
| | graffiato | |
| smalti h2o | real matt | |
| | real satin | |
| | real gloss | |
| | real tech | |
| | smalti | crystal |
| | | crystal sx |
| aderlac hq | | |
| | micafer | |
| industria | rapidex | |
| TermoK8® finiture | rivatone plus g15 | |
| | rivatone plus g12 | |
| | rivatone idrosiliconico plus g15 | |
| | rivatone idrosiliconico plus g12 | |
| | rivatone plus trv g15 | |
| | rivatone plus trv g12 | |
| | rivatone plus trv g10 | |
| | rivatone plus strong g15 | |
| | rivatone plus strong g12 | |
| | rivatone clean plus g15 | |
| | rivatone clean plus g12 | |
| | rivatone clean plus g10 | |
| | fondo k plus | |
| | resin floor | paviglass lucido |
| paviglass opaco | | |
| epoxy paint lt | | |
| davispaint | | |
| | acquatop cover | |
| | acquatop walk | |



Le tinte in queste pagine sono riproduzioni fotografiche e servono ad orientarsi per la selezione del prodotto. Essendo possibili differenze cromatiche tra queste tinte, i campioni, le cartelle colori e la produzione, non sono oggetto di reclamo.



The colors in these pages are photographic reproductions that are used to guide for the products selection. Possible differences in colour between these, samples, colour charts and production are likely to happen, so they are not subject of future complaint. Los colores en estas páginas son reproducciones fotográficas y sirven para orientarse en la selección del producto. Debido a las posibles diferencias de color entre estos, las muestras, las carpetas de color y la producción no serán objeto de queja.

Base

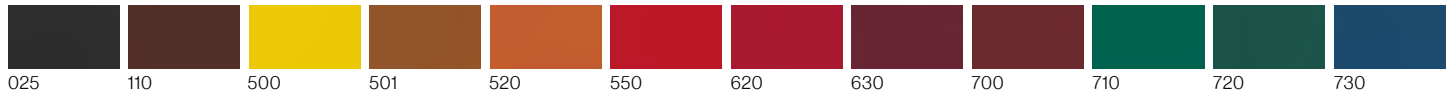

Soffio

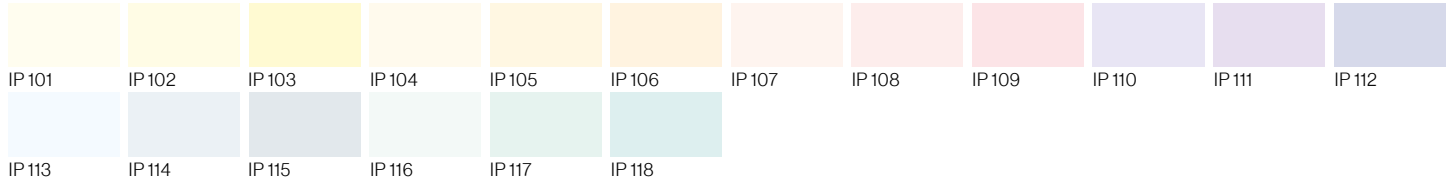

Tenue

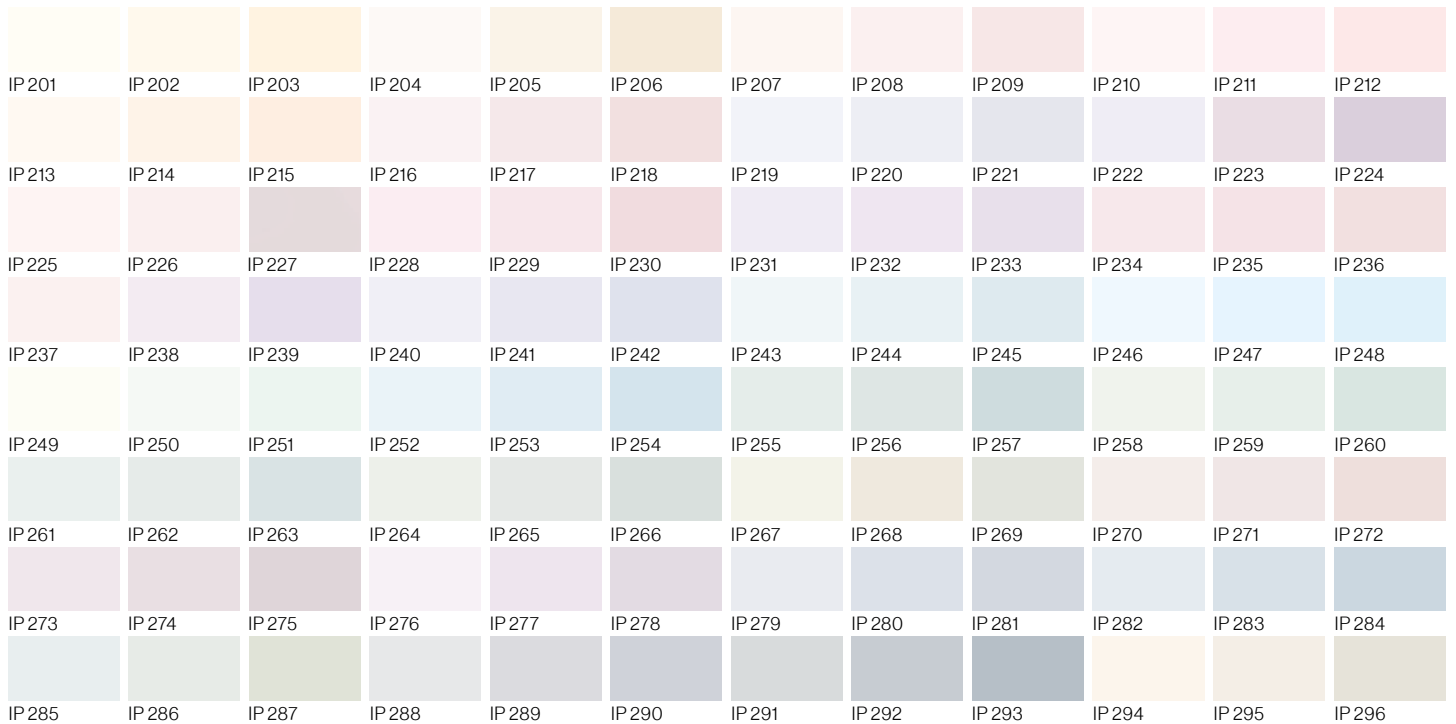

Pastello

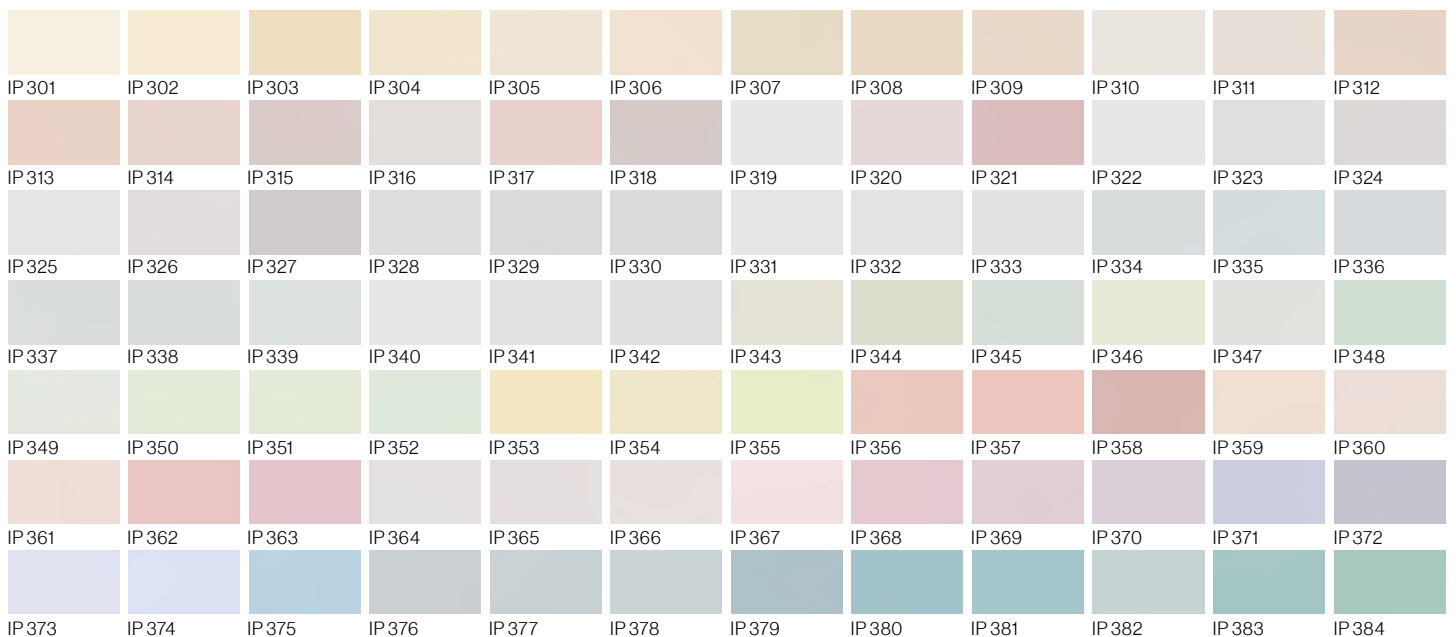

Intenso

| | | | | | | | | | | | |
|--|---|---|---|---|---|---|--|---|---|---|---|
|  |  |  |  |  |  |  |  |  |  |  |  |
| IP 401 | IP 402 | IP 403 | IP 404 | IP 405 | IP 406 | IP 407 | IP 408 | IP 409 | IP 410 | IP 411 | IP 412 |
|  |  |  |  |  |  |  |  |  |  |  |  |
| IP 413 | IP 414 | IP 415 | IP 416 | IP 417 | IP 418 | IP 419 | IP 420 | IP 421 | IP 422 | IP 423 | IP 424 |
|  |  |  |  |  |  |  |  |  |  |  |  |
| IP 425 | IP 426 | IP 427 | IP 428 | IP 429 | IP 430 | IP 431 | IP 432 | IP 433 | IP 434 | IP 435 | IP 436 |
|  |  |  |  |  |  |  |  |  |  |  |  |
| IP 437 | IP 438 | IP 439 | IP 440 | IP 441 | IP 442 | IP 443 | IP 444 | IP 445 | IP 446 | IP 447 | IP 448 |
|  |  |  |  |  |  |  |  |  |  |  |  |
| IP 449 | IP 450 | IP 451 | IP 452 | IP 453 | IP 454 | IP 455 | IP 456 | IP 457 | IP 458 | IP 459 | IP 460 |
|  |  |  |  |  |  |  |  |  |  |  |  |
| IP 461 | IP 462 | IP 463 | IP 464 | IP 465 | IP 466 | IP 467 | IP 468 | IP 469 | IP 470 | IP 471 | IP 472 |
|  |  |  |  |  |  |  |  |  |  |  |  |
| IP 473 | IP 474 | IP 475 | IP 476 | IP 477 | IP 478 | IP 479 | IP 480 | IP 481 | IP 482 | IP 483 | IP 484 |
|  |  |  |  |  |  |  |  |  |  |  |  |
| IP 485 | IP 486 | IP 487 | IP 488 | IP 489 | IP 490 | IP 491 | IP 492 | IP 493 | IP 494 | IP 495 | IP 496 |
|  |  |  |  |  |  |  |  |  |  |  |  |
| IP 497 | IP 498 | IP 499 | IP 500 | IP 501 | IP 502 | IP 503 | IP 504 | IP 505 | IP 506 | IP 507 | IP 508 |
|  |  |  |  |  |  |  |  |  |  |  |  |
| IP 509 | IP 510 | IP 511 | IP 512 | IP 513 | IP 514 | IP 515 | IP 516 | IP 517 | IP 518 | IP 519 | IP 520 |
|  |  |  |  |  |  |  |  |  |  |  |  |
| IP 521 | IP 522 | IP 523 | IP 524 | IP 525 | IP 526 | IP 527 | IP 528 | IP 529 | IP 530 | IP 531 | IP 532 |

Le tinte in queste pagine sono riproduzioni fotografiche e servono ad orientarsi per la selezione del prodotto. Essendo possibili differenze cromatiche tra queste tinte, i campioni, le cartelle colori e la produzione, non sono oggetto di reclamo.

The colors in these pages are photographic reproductions that are used to guide for the products selection. Possible differences in colour between these, samples, colour charts and production are likely to happen, so they are not subject of future complaint.

Los colores en estas páginas son reproducciones fotográficas y sirven para orientarse en la selección del producto. Debido a las posibles diferencias de color entre estos, las muestras, las carpetas de color y la producción no serán objeto de queja.

Off-White

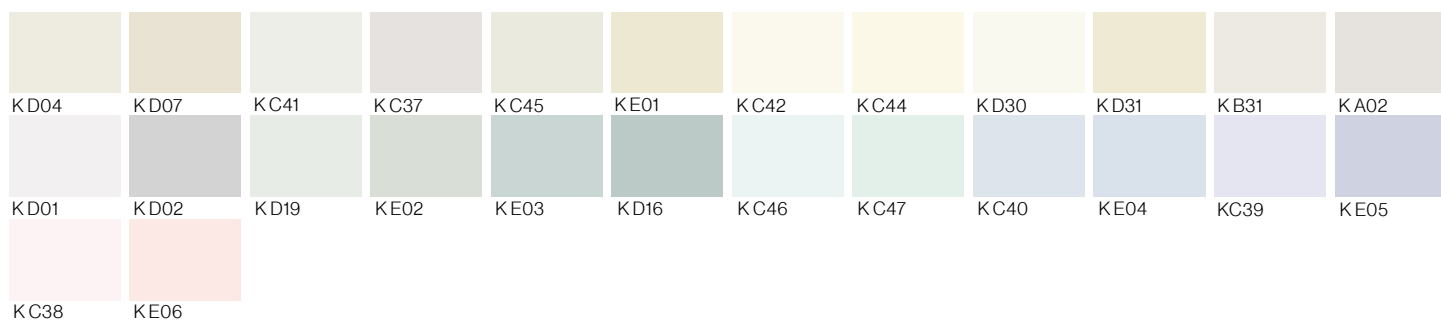

Architectural

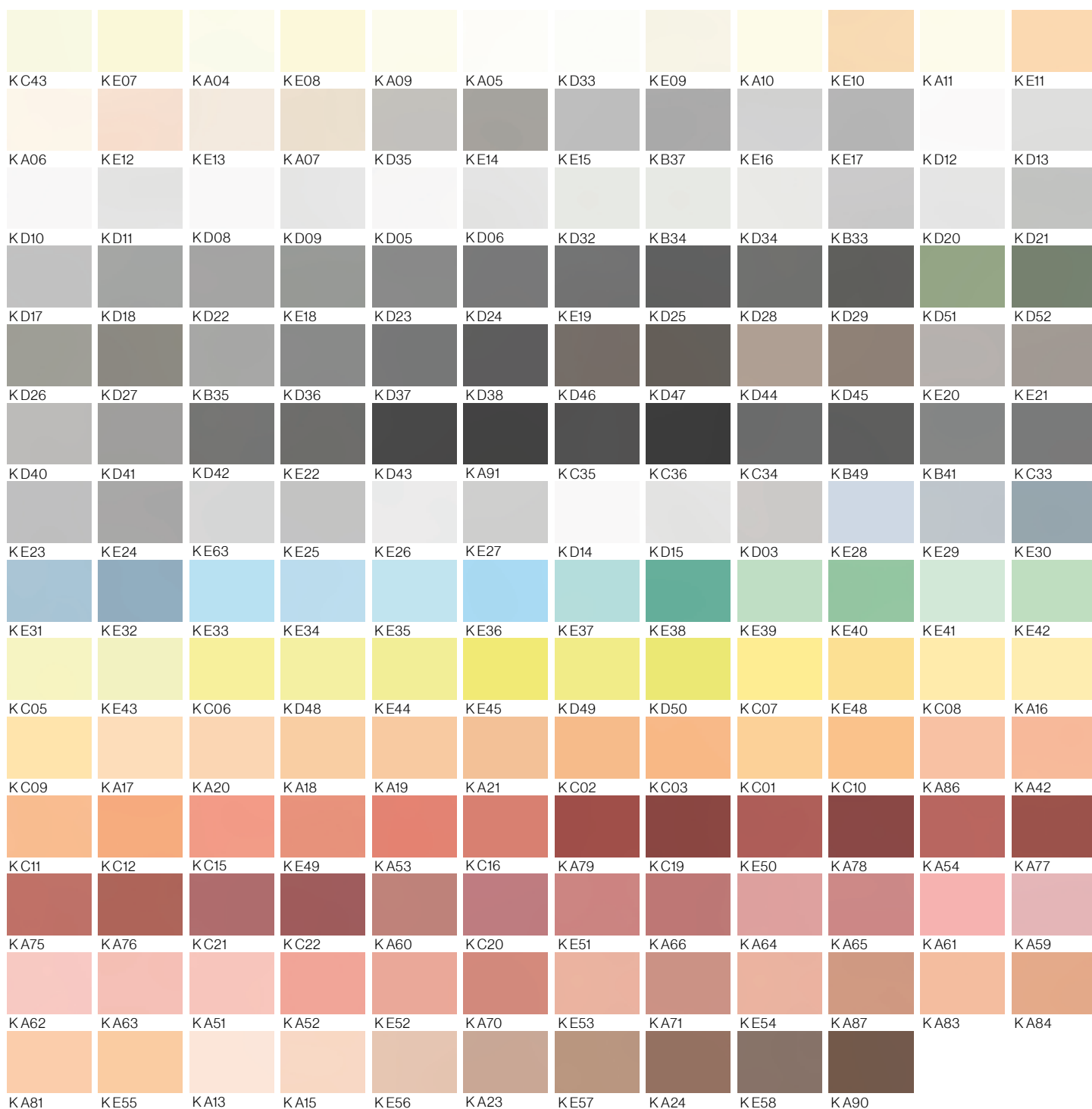

Premium

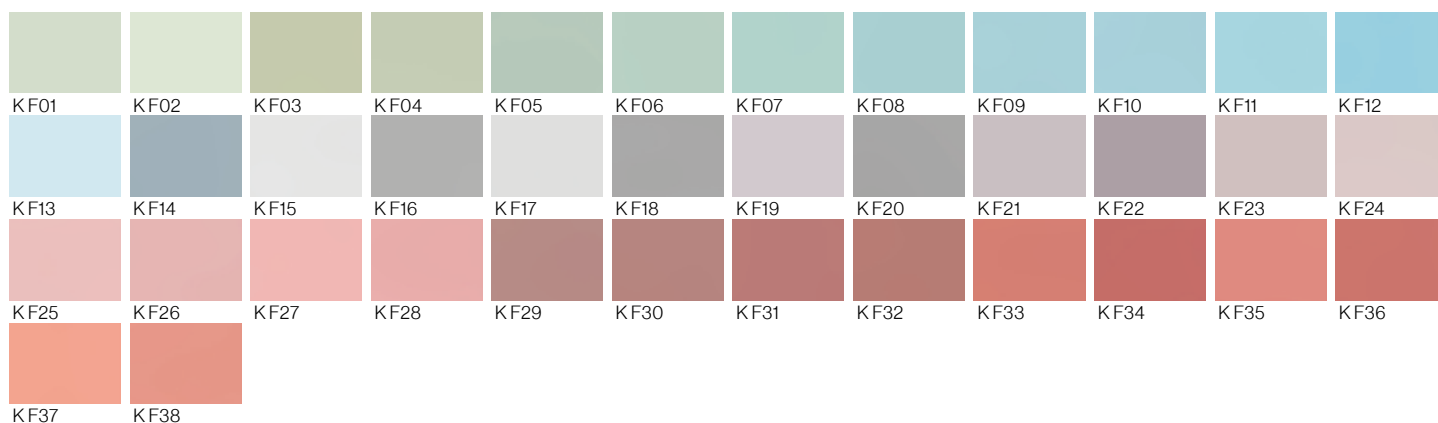

Solar

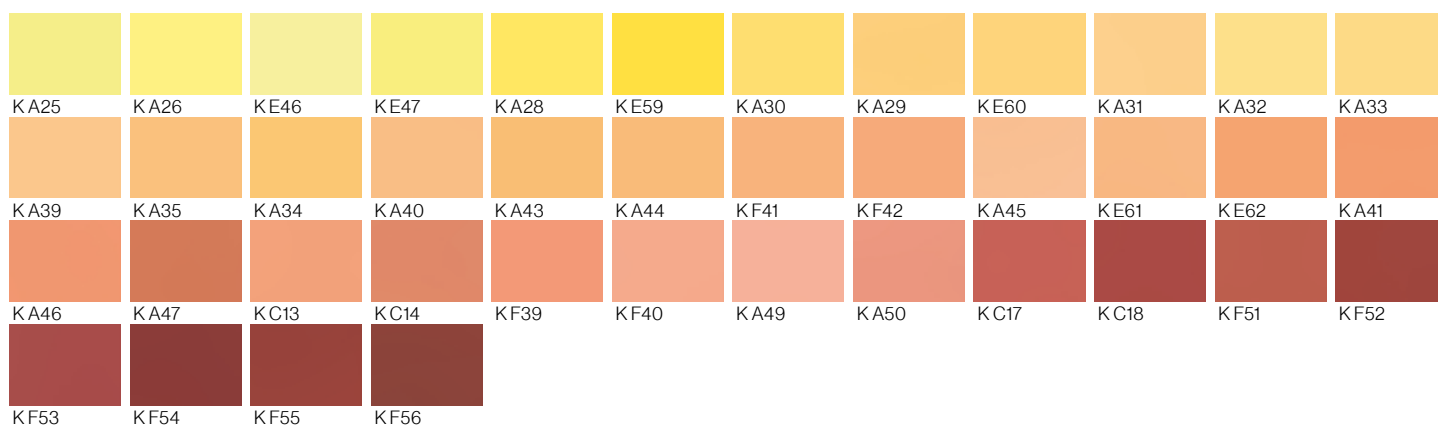

Diamond



Strong

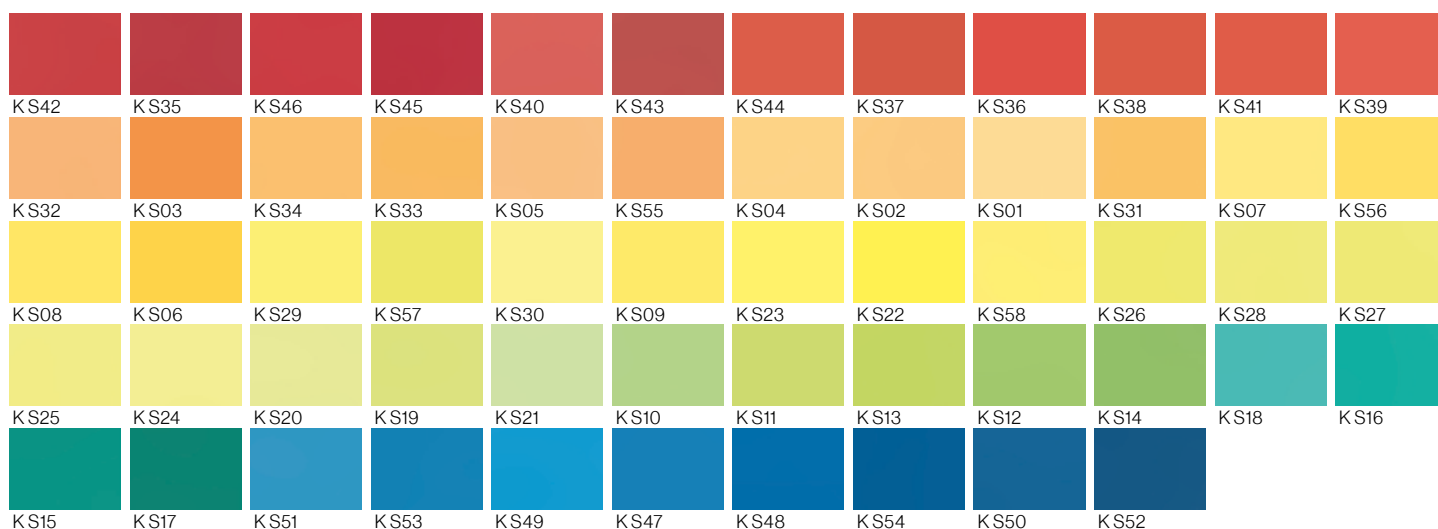

Le tinte in queste pagine sono riproduzioni fotografiche e servono ad orientarsi per la selezione del prodotto. Essendo possibili differenze cromatiche tra queste tinte, i campioni, le cartelle colori e la produzione, non sono oggetto di reclamo.

The colors in these pages are photographic reproductions that are used to guide for the products selection. Possible differences in colour between these, samples, colour charts and production are likely to happen, so they are not subject of future complaint.

Los colores en estas páginas son reproducciones fotográficas y sirven para orientarse en la selección del producto. Debido a las posibles diferencias de color entre estos, las muestras, las carpetas de color y la producción no serán objeto de queja.

Aderlac HQ

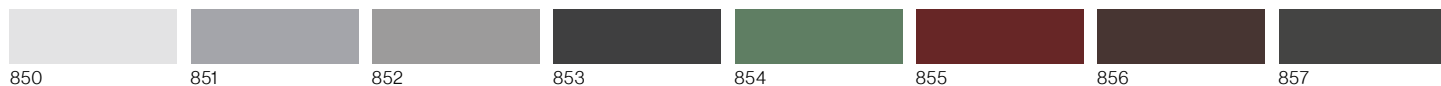

Aquapox



Crystal - Crystal Sx

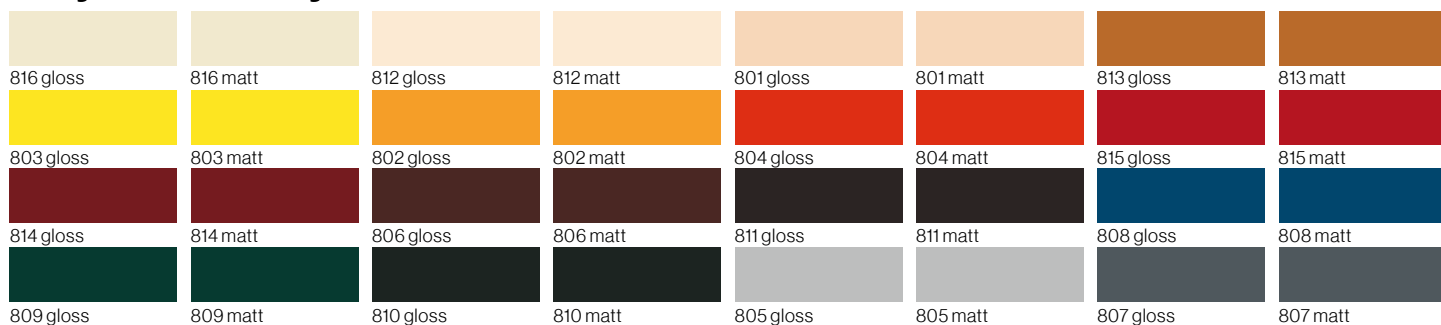

Micafer

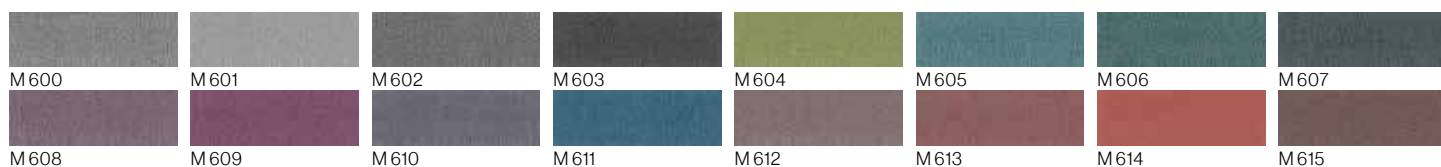

Primex HQ

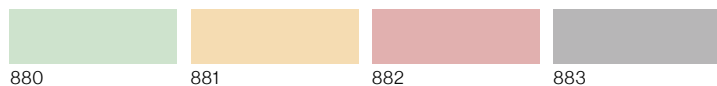

Le tinte in queste pagine sono riproduzioni fotografiche e servono ad orientarsi per la selezione del prodotto. Essendo possibili differenze cromatiche tra queste tinte, i campioni, le cartelle colori e la produzione, non sono oggetto di reclamo.

The colors in these pages are photographic reproductions that are used to guide for the products selection. Possible differences in colour between these, samples, colour charts and production are likely to happen, so they are not subject of future complaint.

Los colores en estas páginas son reproducciones fotográficas y sirven para orientarse en la selección del producto. Debido a las posibles diferencias de color entre estos, las muestras, las carpetas de color y la producción no serán objeto de queja.

RAL Classic K7

| | | | | | | | |
|--|---|---|---|---|--|---|---|
|  |  |  |  |  |  |  |  |
| RAL 1000 | RAL 1001 | RAL 1002 | RAL 1003 | RAL 1004 | RAL 1005 | RAL 1006 | RAL 1007 |
|  |  |  |  |  |  |  |  |
| RAL 1011 | RAL 1012 | RAL 1013 | RAL 1014 | RAL 1015 | RAL 1016 | RAL 1017 | RAL 1018 |
|  |  |  |  |  |  |  |  |
| RAL 1019 | RAL 1020 | RAL 1021 | RAL 1023 | RAL 1024 | RAL 1027 | RAL 1028 | RAL 1032 |
|  |  |  |  |  |  |  |  |
| RAL 1033 | RAL 1034 | RAL 1037 | RAL 2000 | RAL 2001 | RAL 2002 | RAL 2003 | RAL 2004 |
|  |  |  |  |  |  |  |  |
| RAL 2008 | RAL 2009 | RAL 2010 | RAL 2011 | RAL 2012 | RAL 3000 | RAL 3001 | RAL 3002 |
|  |  |  |  |  |  |  |  |
| RAL 3003 | RAL 3004 | RAL 3005 | RAL 3007 | RAL 3009 | RAL 3011 | RAL 3012 | RAL 3013 |
|  |  |  |  |  |  |  |  |
| RAL 3014 | RAL 3015 | RAL 3016 | RAL 3017 | RAL 3018 | RAL 3020 | RAL 3022 | RAL 3027 |
|  |  |  |  |  |  |  |  |
| RAL 3028 | RAL 3031 | RAL 4001 | RAL 4002 | RAL 4003 | RAL 4004 | RAL 4005 | RAL 4006 |
|  |  |  |  |  |  |  |  |
| RAL 4007 | RAL 4008 | RAL 4009 | RAL 4010 | RAL 5000 | RAL 5001 | RAL 5002 | RAL 5003 |
|  |  |  |  |  |  |  |  |
| RAL 5004 | RAL 5005 | RAL 5007 | RAL 5008 | RAL 5009 | RAL 5010 | RAL 5011 | RAL 5012 |
|  |  |  |  |  |  |  |  |
| RAL 5013 | RAL 5014 | RAL 5015 | RAL 5017 | RAL 5018 | RAL 5019 | RAL 5020 | RAL 5021 |
|  |  |  |  |  |  |  |  |
| RAL 5022 | RAL 5023 | RAL 5024 | RAL 6000 | RAL 6001 | RAL 6002 | RAL 6003 | RAL 6004 |
|  |  |  |  |  |  |  |  |
| RAL 6005 | RAL 6006 | RAL 6007 | RAL 6008 | RAL 6009 | RAL 6010 | RAL 6011 | RAL 6012 |
|  |  |  |  |  |  |  |  |
| RAL 6013 | RAL 6014 | RAL 6015 | RAL 6016 | RAL 6017 | RAL 6018 | RAL 6019 | RAL 6020 |
|  |  |  |  |  |  |  |  |
| RAL 6021 | RAL 6022 | RAL 6024 | RAL 6025 | RAL 6026 | RAL 6027 | RAL 6028 | RAL 6029 |
|  |  |  |  |  |  |  |  |
| RAL 6032 | RAL 6033 | RAL 6034 | RAL 6037 | RAL 7000 | RAL 7001 | RAL 7002 | RAL 7003 |
|  |  |  |  |  |  |  |  |
| RAL 7004 | RAL 7005 | RAL 7006 | RAL 7008 | RAL 7009 | RAL 7010 | RAL 7011 | RAL 7012 |
|  |  |  |  |  |  |  |  |
| RAL 7013 | RAL 7015 | RAL 7016 | RAL 7021 | RAL 7022 | RAL 7023 | RAL 7024 | RAL 7026 |
|  |  |  |  |  |  |  |  |
| RAL 7030 | RAL 7031 | RAL 7032 | RAL 7033 | RAL 7034 | RAL 7035 | RAL 7036 | RAL 7037 |
|  |  |  |  |  |  |  |  |
| RAL 7038 | RAL 7039 | RAL 7040 | RAL 7042 | RAL 7043 | RAL 7044 | RAL 7045 | RAL 7046 |
|  |  |  |  |  |  |  |  |
| RAL 7047 | RAL 8000 | RAL 8001 | RAL 8002 | RAL 8003 | RAL 8004 | RAL 8007 | RAL 8008 |
|  |  |  |  |  |  |  |  |
| RAL 8011 | RAL 8012 | RAL 8014 | RAL 8015 | RAL 8016 | RAL 8017 | RAL 8019 | RAL 8022 |
|  |  |  |  |  |  |  |  |
| RAL 8023 | RAL 8024 | RAL 8025 | RAL 8028 | RAL 9001 | RAL 9002 | RAL 9003 | RAL 9004 |
|  |  |  |  |  |  |  |  |
| RAL 9005 | RAL 9006 | RAL 9007 | RAL 9010 | RAL 9011 | RAL 9016 | RAL 9017 | RAL 9018 |



corner
espos

corner espositivi

I corner espositivi rappresentano un modo nuovo di proporre i prodotti e le soluzioni ivas all'interno dei punti vendita, attraverso moduli componibili a seconda delle necessità e degli spazi disponibili.

The exhibition corners represent a new way of showing our products and solutions inside every store, through modular units according to needs and space availability.

Los rincones expositivos representan una nueva forma de proponer productos y soluciones ivas al interior de las tiendas, a través de elementos modulares de acuerdo a las necesidades y espacios disponibles.

s sitivi

| | | |
|--|---|---|
| <p>I corner espositivi rappresentano un modo nuovo di proporre i prodotti e le soluzioni ivas all'interno dei punti vendita, attraverso moduli componibili a seconda delle necessità e degli spazi disponibili.</p> | <p>The exhibition corners represent a new way of proposing ivas products and solutions into the stores, through modular modules according to the needs and to the available spaces.</p> | <p>Los rincones expositivos representan una nueva forma de proponer productos y soluciones ivas al interior de las tiendas, a través de elementos modulares de acuerdo a las necesidades y espacios disponibles.</p> |
| <p>componenti strutturali comuni:</p> <ul style="list-style-type: none"> - struttura metallica autoportante tubolare cm 30x30 - cappello melamminico laccato cm 30x38x90 completo di n° 2 faretti led - schiena melamminica laccata cm 60+147x90c - base melamminica laccata 50x90cm - piedini regolabili autolivellanti - piede posteriore aggiuntivo per configurazione autoportante - accessori di sicurezza antiribaltamento - finitura poliuretana antigraffio | <p>common structural components:</p> <ul style="list-style-type: none"> - self-supporting tubular metal structure 30x30 cm lacquered melamine hat 30x38x90 cm complete with 2 led spotlights - lacquered melamine back cm 60 + 147x90 - lacquered melamine base 50x90cm - self-leveling adjustable feet - additional rear foot for self-supporting configuration - rollover safety accessories - scratch-resistant polyurethane finish | <p>componentes estructurales comunes:</p> <ul style="list-style-type: none"> - estructura metálica tubular autoportante 30x30 cm tapa de melamina lacada cm 30x38x90 completa con n° 2 focos led - respaldo de melamina lacada cm 60+147x90c - base de melamina lacada 50x90cm - pies regulables y autonivelantes - pie trasero adicional para la configuración autoportante - accesorios de seguridad antivuelco - acabado poliuretano antirayaduras |
| <p>accessori:</p> <ul style="list-style-type: none"> - fianchi di chiusura - colonna angolare - schiena di finitura | <p>Accessories:</p> <ul style="list-style-type: none"> - closing sides - corner column - finishing back | <p>accessori:</p> <ul style="list-style-type: none"> - lados de cierre - column angular - acabado de vuelta |
| <p>specifiche moduli singoli:</p> <p><u>modulo con tecnigrafo</u></p> <ul style="list-style-type: none"> - "tecnigrafo" con piano inclinato magnetizzato cm 125x50x90, griglia magnetica con 18 campioni cm12x15 "colori dell'anno". Possibilità di sostituire la griglia con un monitor professionale 32" (opzionale) <p><u>modulo interior trends</u></p> <ul style="list-style-type: none"> - "muro del colore" con tutti i campioni delle tinte IT per interno griglia magnetica con 144 campioni cm 12x5,5 <p><u>modulo TermoK8</u></p> <ul style="list-style-type: none"> - selezione di 8 campioni di sistemi a cappotto cm 40x40 removibili, con sistema di fissaggio autolivellante in tinta con la schiena <p><u>modulo cicli tecnici</u></p> <ul style="list-style-type: none"> - strutture con n. 3 pannelli girevoli bifacciali cm 133x28 (cadauno) mobile contenitore laccato cm 60x50x90 completo di top aggiuntivo <p><u>modulo pavimenti in resina</u></p> <ul style="list-style-type: none"> - strutture con n. 3 pannelli girevoli bifacciali cm 133x28 (cadauno) mobile contenitore laccato cm 60x50x90 completo di top aggiuntivo <p><u>modulo decorativi</u></p> <ul style="list-style-type: none"> - griglia magnetica con 16 campioni Metropolis cm 18,75x30 intercambiabili, mobile contenitore laccato cm 60x50x90 completo di top aggiuntivo contenete un ulteriore set di campioni magnetici. | <p>single modules specifics:</p> <p><u>module with drafting machine</u></p> <ul style="list-style-type: none"> - "drafting machine" with magnetized inclined plane 125x50x90, magnetic grid with 18 samples cm12x15 "colours of the year". Possibility to replace the grid with a professional monitor 32" (optional) <p><u>interior trends module</u></p> <ul style="list-style-type: none"> - "wall of colour" with all the color samples IT for interiors magnetic grid with 144 samples cm 12x5,5 <p><u>termoK8 module</u></p> <ul style="list-style-type: none"> - Selection of 8 samples of external insulation systems cm 40x40 removable, with self-leveling fixing system matching the back. <p><u>technical cycles module</u></p> <ul style="list-style-type: none"> - Structures with n.3 double-sided rotating panels cm 133x28 (each one) mobile lacquered container cm 60x50x90 complete with additional top <p><u>resin floor module</u></p> <ul style="list-style-type: none"> - Structures with n. 3 double-sided rotating panels cm 133x28 (each one) mobile lacquered container cm 60x50x90 complete with additional top <p><u>decorative module</u></p> <ul style="list-style-type: none"> - Magnetic grid with 16 samples of Metropolis cm 18,75x30 interchangeable, mobile lacquered container cm 60x50x90 complete with additional top containing an extra set of magnetic samples. | <p>specifiche moduli singoli:</p> <p><u>módulo de dibujo técnico</u></p> <ul style="list-style-type: none"> - "tecnigrafo" con piano inclinato magnetizzato cm 125x50x90, griglia magnetica con 18 campioni cm12x15 "colores dell'anno". Possibilità di sostituire la griglia con un monitor professionale 32" (opzionale) <p><u>modulo interior trends</u></p> <ul style="list-style-type: none"> - "muro de color" con todas las muestras de color IT para interior rejilla magnética con 144 muestras 12x5,5 cm <p><u>módulo TermoK8</u></p> <ul style="list-style-type: none"> - selección de 8 muestras de sistemas de revestimiento de 40x40 cm desmontable, con sistema de fijación autonivelante a juego con el soporte <p><u>módulo ciclos técnicos</u></p> <ul style="list-style-type: none"> - estructura con no. 3 paneles giratorios de doble cara cm 133x28 (cada uno) mueble de almacenamiento lacado cm 60x50x90 completo con tapa adicional <p><u>módulo pavimentos en resina</u></p> <ul style="list-style-type: none"> - estructura con no. 3 paneles giratorios de doble cara cm 133x28 (cada uno) mueble de almacenamiento lacado cm 60x50x90 completo con tapa adicional <p><u>módulo decorativos</u></p> <ul style="list-style-type: none"> - rejilla magnética con 16 muestras intercambiables de Metropolis 18,75x30 cm, armario lacado cm 60x50x90 completo con tapa adicional que contiene un conjunto adicional de muestras magnéticas |

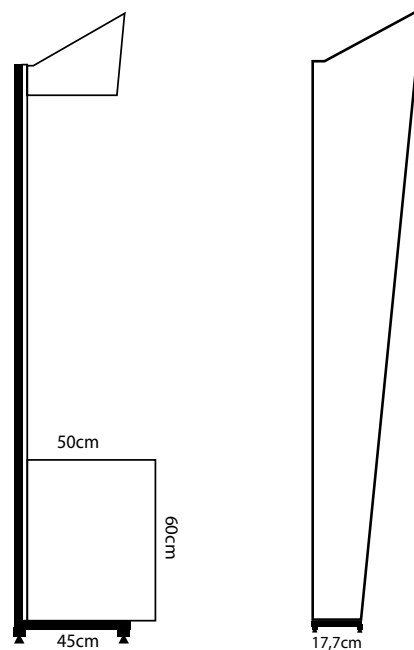
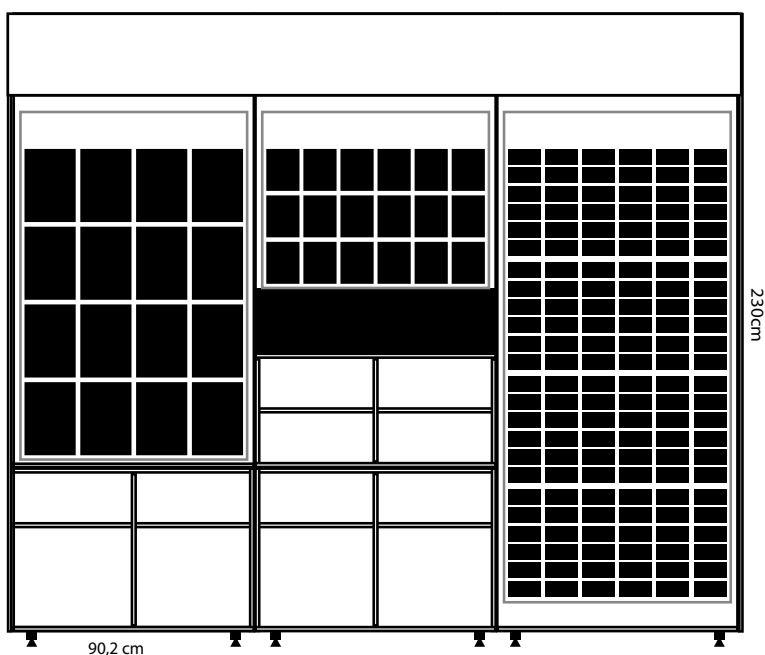

Configurazione lineare
Montaggio a parete oppure autoportante (anche bifacciale)



Configurazione angolare
Montaggio a parete oppure autoportante, con angolo accessorio



Configurazione freestanding
Montaggio autoportante monofacciale oppure bifacciale



Configurazione ad isola
Montaggio "a torre" centrale, 4 moduli a pianta quadrata





**strumente
vendite**

strumenti di vendita

Ivas presenta una linea completa e rinnovata di strumenti di comunicazione, promozione e vendita. Al suo interno sono disponibili i cataloghi, i manuali tecnici, le cartelle colore e tutti gli strumenti di comunicazione delle principali linee di prodotto.

Ivas presents a complete and renewed line of communication, promotion and sales tools. Internally it presents Catalogs, technical sheets, color folders and all communication tools

Ivas presenta una completa y renovada línea de instrumentos de comunicación, promoción y venta. Los catálogos están disponibles en su interior, manuales técnicos, cartas de colores y todas las herramientas de comunicación de las principales líneas de productos.



enti di a

| | | | |
|---|-----|--------------------------------------|-----|
| A | | | |
| acquatop cover | 275 | copritassel | 165 |
| acquatop fix | 274 | corindone bianco | 276 |
| acquatop primer | 274 | corindone bruno | 276 |
| acquatop walk | 275 | cornice sottogronda | 198 |
| acrilica 100 | 81 | crystal | 94 |
| acrilux | 104 | crystal sx | 94 |
| adefix 12 bianco | 135 | D | |
| adefix 12 grigio | 135 | davanzali ALU | 184 |
| aderlac hq | 95 | davanzali GFB | 184 |
| aeropan | 161 | davispaint | 265 |
| aerosil 200 | 277 | deco sand plus | 57 |
| agitatore elettronico giroscopico | 288 | deco sand plus | 57 |
| agitatore manuale giroscopico | 288 | detergente ac | 110 |
| algasol | 104 | diluyente nitro antinebbia | 119 |
| amianfix | 108 | diluyente per epossidici | 119 |
| angolare esterno | 253 | diluyente per poliuretani | 119 |
| angolare interno | 253 | diluyente per spartitraffico | 119 |
| antigraffiti w | 103 | diluyente sintetico | 119 |
| antiruggine per carrozzeria | 116 | E | |
| aquacem | 261 | elastucco | 84 |
| aquacem autolivellante | 261 | elementi di compensazione | 178 |
| aquapox | 264 | enjoy 1 coat | 17 |
| armatex C1 | 186 | epoplast | 270 |
| armatex C1 M | 187 | epoplast 61 | 272 |
| armatex C1 R | 186 | epoplast as | 271 |
| armatex micro | 113 | epoplast flex | 271 |
| artemisia | 226 | epoplast w | 270 |
| artemisia rasopietra | 226 | epoxy bond | 262 |
| asfodelo | 224 | epoxy fondo | 260 |
| asfodelo 530 bianco | 225 | epoxy fondo as | 261 |
| asfodelo rinzafo antisale | 224 | epoxy fondo oil | 260 |
| asfodelo risanante | 225 | epoxy paint ht | 264 |
| | | epoxy paint lt | 265 |
| B | | epoxy primer wb | 258 |
| banda | 253 | epoxy primer xb | 258 |
| bandella di rame | 280 | epozinco | 116 |
| barra di fissaggio Vari Q | 180 | eps 31-G 100 fix R | 153 |
| betonglass lucido | 59 | eps 31-G max R | 153 |
| betonglass opaco | 59 | eps 35-100 fix R | 152 |
| biancocalce | 33 | eps 35 max R | 152 |
| bianco interno | 33 | eps 35 plus | 156 |
| bio-past | 112 | eps G meccanico R | 153 |
| bitum flex | 109 | eps meccanico R | 152 |
| bloccafumo | 81 | espositore prodotti vita sana | 42 |
| bugna | 199 | | |
| | | F | |
| C | | fibra di legno | 161 |
| capsulit | 108 | finquarz | 68 |
| cassetta elettrica Eldoline EPS | 180 | fondo H2O per legno | 98 |
| catalizzatore z8 | 113 | fondo K plus | 195 |
| celertow | 237 | fondo per legno | 98 |
| cerato | 127 | fresa per risanamento PTZ | 200 |
| cips colorate | 277 | fresa per risanamento STR | 200 |
| clean matt | 24 | G | |
| clorex | 117 | giunto di dilatazione plus PVC-R | 177 |
| cloro-pool | 123 | glueflex bianco | 230 |
| colonna porta gel | 45 | glueflex grigio | 230 |
| coloranti concentrati youcolor rie per prodotti all'acqua | 290 | glueflex hp bianco | 231 |
| coloranti concentrati youcolor rie per prodotti al solvente | 290 | glueflex hp grigio | 231 |
| coloranti concentrati youcolor ri per prodotti all'acqua | 290 | glueflex modular big bianco | 142 |
| coloranti concentrati youcolor ri per prodotti al solvente | 290 | glueflex modular big grigio | 142 |
| coloranti universali re | 87 | glueflex p | 143 |
| coloranti universali ri | 87 | glueflex ultra bianco | 232 |
| color reader | 289 | glueflex ultra grigio | 232 |
| converto 30 BW | 150 | graffiato | 69 |
| converto 30-G | 146 | grafinet | 110 |
| converto 31 BW | 150 | griptow | 209 |
| converto 31-G plus | 146 | guarnizione grande | 253 |
| converto 34 BW | 151 | guarnizione piccola | 253 |
| converto 35-100 | 148 | I | |
| converto fonostop | 147 | idrobeton | 56 |
| converto HP | 147 | idrocerato | 129 |
| converto P 200 | 148 | idrofill | 129 |
| converto P 200 HP | 154 | idroflating | 128 |
| | | idroflating opaco | 128 |
| | | idrofless gloss | 34 |
| | | idrofless matt | 34 |
| | | idrofumo | 35 |
| | | idrogloss | 21 |
| | | idromatt | 20 |
| | | idrosatin | 20 |
| | | inserto dart-set | 179 |
| | | inserto di rinforzo Quadroline | 180 |
| | | inserto per il montaggio CT 2G | 200 |
| | | inserto per il montaggio CT L | 200 |
| | | inserto per il montaggio CT S1 | 201 |
| | | inter-pool | 122 |
| | | intogum plus g10 | 62 |
| | | intogum plus g12 | 62 |
| | | intonachino idrosiliconico plus g06 | 63 |
| | | intonachino idrosiliconico plus g08 | 63 |
| | | iso-bar | 179 |
| | | iso-corner | 182 |
| | | iso-corner kit SDF | 183 |
| | | iso-corner kit SDP | 183 |
| | | ivaglass lucido | 58 |
| | | ivaglass opaco | 58 |
| | | ivapox antiacido | 268 |
| | | ivasgum fondo | 77 |
| | | ivasgum side finitura | 55 |
| | | ivasil fondo | 77 |
| | | ivasil intonachino g08 | 65 |
| | | ivasil pittura | 56 |
| | | ivasil primer s | 81 |
| | | ivastucco | 84 |
| | | K | |
| | | kit montaggio profili di base | 178 |
| | | kit ricambi per talpa - CT 2G e CT L | 201 |
| | | klebocalce naturale | 140 |
| | | klebocem | 134 |
| | | klebocem fibrato | 138 |
| | | klebocem grosso | 134 |
| | | klebocem minerale | 140 |
| | | klebocem r 110 j | 139 |
| | | klebocem termico | 138 |
| | | klebocem ultra | 139 |
| | | L | |
| | | lana di roccia doppia densità | 158 |
| | | lana di roccia monodensità | 158 |
| | | lana di vetro k34 | 159 |
| | | lecocem 100 | 136 |
| | | listello a mano san marco | 196 |
| | | listello facciavista | 196 |
| | | listello flex | 196 |
| | | listello buchthal | 196 |
| | | luxury | 24 |
| | | M | |
| | | malta modellabile | 237 |
| | | marcapiano | 198 |
| | | marineria | 126 |
| | | marineria opaco | 126 |
| | | micafer | 95 |
| | | microfibra 80 | 277 |
| | | minio oleofenolico | 99 |
| | | mixer glos | 287 |
| | | monoflex | 247 |
| | | multipor | 159 |
| | | mural blu | 32 |
| | | muralpac liscio | 109 |
| | | mural verde | 29 |
| | | N | |
| | | nastro autoespandente sigillante BG1 | 175 |
| | | nitrofix | 80 |
| | | novostucco | 85 |
| | | P | |
| | | paraspigolo angolare AL | 170 |
| | | paraspigolo angolare AL-R | 171 |
| | | paraspigolo angolare archi PVC | 171 |
| | | paraspigolo angolare flex PVC-R | 172 |
| | | paraspigolo angolare PVC | 171 |
| | | paraspigolo angolare PVC-R | 171 |
| | | parastuck | 144 |
| | | parastuck mf | 143 |

| | |
|---|---------|
| paviglass lucido | 266 |
| paviglass opaco | 266 |
| perline vetro | 277 |
| PH 20 | 160 |
| PH 20 king | 161 |
| piastra per carichi pesanti ump-alu-tr | 181 |
| pittura per interni extra | 32 |
| polybeton ht | 278 |
| polybeton ls | 278 |
| polyelastic | 272 |
| polyfast ib | 279 |
| polyfast p | 279 |
| primacril | 80 |
| primer mma | 259 |
| primer-pool | 122 |
| primer ra | 251 |
| primer tack | 251 |
| primer therm | 39 |
| prime tech | 76 |
| primex hq | 99 |
| profilo C di colmo | 174 |
| profilo CO di contenimento | 174 |
| profilo con gocciolatoio PVC-R | 172 |
| profilo di base | 170 |
| profilo di base PVC-R | 170 |
| profilo di chiusura PVC-R | 174 |
| profilo di collegamento PVC-R | 173 |
| profilo di connessione PVC U-AL | 167 |
| profilo di connessione TYP U | 167 |
| profilo di giunto semplice GA-R | 177 |
| profilo di giunto semplice GL-R | 177 |
| profilo finestre plus 3d PVC-R | 173 |
| profilo finestre plus PVC-R | 173 |
| profilo finestre PVC-R | 172 |
| profilo orizzontale OR/LT | 168 |
| profilo orizzontale PVC OR/LT | 168 |
| profilo per rivestimenti modulari | 175 |
| profilo SD sottodanzale | 172 |
| profilo verticale PVC VR/LT | 169 |
| profilo verticale VR/LT | 169 |
| punta per trapano high speed | 200 |
| Q | |
| quarzo 02 | 276 |
| quarzo 04 | 276 |
| quarzo 06 | 276 |
| quarzogum plus | 55 |
| quarzoplast | 68 |
| R | |
| rapidex | 117 |
| rasaltow 108 bianco | 214 |
| rasaltow beton bianco | 215 |
| rasaltow beton grigio | 215 |
| rasaltow bianco | 213 |
| rasaltow grigio | 213 |
| rasaltow max bianco | 212 |
| rasaltow max grigio | 212 |
| rasaltow plus 1.0 | 214 |
| rasofondo color | 76 |
| rasofondo flex | 77 |
| rasogum | 141 |
| real gloss | 91 |
| real matt | 90 |
| real satin | 90 |
| real tech | 91 |
| resintow | 251 |
| rete fazzoletto per armatura spigoli finestre | 187 |
| rete angolare per intradossi aperture | 187 |
| rete fuga decorativa | 176 |
| rete fuga decorativa angolo esterno | 176 |
| rete fuga decorativa angolo interno | 176 |
| reverso | 154 |
| rivasil g12 | 64 |
| rivasil g15 | 64 |
| rivatone clean plus g10 | 195 |
| rivatone clean plus g12 | 194 |
| rivatone clean plus g15 | 194 |
| rivatone idrosiliconico plus g12 | 189 |
| rivatone idrosiliconico plus g15 | 189 |
| rivatone plus g12 | 188 |
| rivatone plus g15 | 188 |
| rivatone plus reflect g12 | 192 |
| rivatone plus reflect g15 | 192 |
| rivatone plus strong g12 | 193 |
| rivatone plus strong g15 | 193 |
| rivatone plus trv g10 | 191 |
| rivatone plus trv g12 | 190 |
| rivatone plus trv g15 | 190 |
| rompigoccia per base di partenza-R | 170 |
| rondella per lana di roccia 90 mm | 165 |
| rondella per lana di roccia 140 mm | 165 |
| rondella per lana di roccia VT 2G | 164 |
| rugoplast | 69 |
| rusty | 99 |
| S | |
| sana bianca | 40 |
| sana finish | 40 |
| sana rasothersm | 40 |
| sana salute gel | 44 |
| sana salute oxy | 45 |
| sana salute pro indoor | 44 |
| sana salute pro outdoor | 45 |
| sana salute spray | 44 |
| sana salute sprayer pump | 45 |
| sanasil-bio | 41 |
| sana solux | 41 |
| sana solux spray | 41 |
| sigil pol | 141 |
| sigil tow fl | 236 |
| sigil tow universale | 236 |
| silacril | 103 |
| silan tech | 28 |
| silcal | 102 |
| silcal w | 102 |
| silofix | 80 |
| silox plus | 52 |
| software datacolor paint color cardmatch | 288 |
| software datacolor paint efb | 288 |
| software per spettrofotometro | 288 |
| sol-tex | 25 |
| spalletta isolante per imbotte lai-sys eps | 166 |
| spalletta isolante per imbotte lai-sys mw | 166 |
| spalletta isolante per imbotte lai-sys pu | 166 |
| spartitraffico | 111 |
| spatola sagomata | 201 |
| spettrofotometro datacolor d20 | 289 |
| stampante dymo label writer 550 | 289 |
| stiferite class SK | 160 |
| stonet | 110 |
| stucco in polvere | 85 |
| sughero ambrato | 160 |
| superclean plus | 53 |
| superquarz plus | 52 |
| superquarz plus reflect | 54 |
| superquarz plus strong | 54 |
| supporto di fissaggio frontale tra-wik-alu-rf | 181 |
| supporto di fissaggio k1-pe | 181 |
| supporto di fissaggio laterale tra-wik-alu-rl | 182 |
| sverniciatore n11 | 112 |
| T | |
| tagliatrice per eps da ponteggio | 201 |
| talpa per tassello CT 2G - CT L | 201 |
| talpa per tassello CT S1 | 201 |
| tappo in EPS per tassello CT 2G - CT L | 165 |
| tassello CT 2G | 162 |
| tassello CT L | 163 |
| tassello CT L A2 | 163 |
| tassello CT S1 | 163 |
| tassello di ancoraggio a spirale | 178 |
| tassello H2 | 162 |
| tassello H3 | 164 |
| tassello ND K | 164 |
| tassello SDK U | 164 |
| tech active | 25 |
| terminale per sottotetto PVC-R | 173 |
| TermoK8 foam | 141 |
| tessuto di vetro | 280 |
| thinner fill | 127 |
| tintometro a4b | 284 |
| tintometro d600 minimodula | 286 |
| tintometro elettronico d300 | 285 |
| tintometro elettronico d700 | 286-287 |
| tintometro ha480 | 285 |
| tintometro manuale | 284 |
| totem promozionale vita sana | 42 |
| tow bf | 219 |
| tow bk bianco | 219 |
| tow bk grigio | 218 |
| tow bn anticarbonatazione | 218 |
| tow bn r bianco | 221 |
| tow bn r grigio | 221 |
| towcem | 209 |
| towrip | 206 |
| towrip 108 | 206 |
| towrip betoncino | 207 |
| towrip colabile | 207 |
| towrip & finish | 208 |
| towrip rapido | 208 |
| towseal | 247 |
| towflex | 246 |
| towflex ap | 246 |
| tow level | 243 |
| towpruf | 248 |
| tow-rin | 241 |
| towsan | 240 |
| towsan finitura | 241 |
| towsan light | 240 |
| towsan primer | 240 |
| traspicolor active | 16 |
| traspinterno | 28 |
| U | |
| ultra dry | 53 |
| uniform bianco | 220 |
| uniform grigio | 220 |
| V | |
| vita bianca | 38 |
| vita therm | 39 |
| vita wash | 38 |
| W | |
| white cream | 29 |
| Z | |
| zincobrill | 111 |

contatti

Ivas Industria Vernici Spa
via Bellaria 40 · 47030
San Mauro Pascoli · FC · Italia

tel. +39 0541 815811
mail ivas@gruppivas.com
web gruppivas.com

edizione 05/2022

Company with quality management system certified UNI EN ISO 9001